

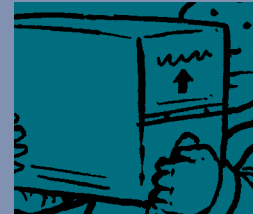

SAFETY ABOARD FISHING VESSELS



SAFETY ABOARD FISHING VESSELS

A Practical Guide for Crew Members

Compiled by Alastair Robertson

Illustrated by Dean Raybould

Graphic Design & Production by
Karen Jones & Archetype Creative Services Ltd
Nelson, New Zealand

This handbook was produced with financial support from
the Government of Taiwan/ROC

MARINE RESOURCES DIVISION COASTAL FISHERIES PROGRAMME TRAINING SECTION



SECRETARIAT OF THE PACIFIC COMMUNITY

Noumea, New Caledonia

1998

© **Copyright Secretariat of the Pacific Community 1998**

The Secretariat of the Pacific Community authorises the reproduction of this material, whole or in part, in any form, provided that appropriate acknowledgement is given.

First printed, June 1998

Original text: English

Secretariat of the Pacific Community Cataloguing-in-publication data

Secretariat of the Pacific Community

Robertson, Alastair

Safety Aboard Fishing Vessels : A Practical Guide for Crew Members / compiled by Alastair Robertson

1. Fishing boats—Safety
2. Fisheries—Oceania—Safety measures
3. Fishing boats—Handbooks, manuals etc
- I. Title II. Secretariat of the Pacific Community

363.123

AACR2

ISBN 982 – 203 – 617 – 5

Secretariat of the Pacific Community

BP D5

98848 Noumea Cedex

New Caledonia

telephone: +687 26 20 00 - facsimile: +687 26 38 18 - email: spc@spc.int - web site: <http://www.spc.int/>

CONTENTS

List of Taiwanese and Japanese Terms.....	4
Parts of a Fishing Vessel	8
Parts of an Inflatable Liferaft.....	11
Life Raft Equipment.....	12
Launching the Life Raft.....	14
Survival After Launching.....	15
First Aid Equipment	16
Safety on Deck	17
Causes of Fire	19
Fire Fighting Principles and Organisation.....	21
Fire Fighting Equipment	22
HIV/AIDS	23
Pollution.....	24

LIST OF TAIWANESE AND JAPANESE TERMS

	ENGLISH	TAIWANESE	JAPANESE
CREW	Captain	Chwan Jaang	Senshou
	Chief engineer	Luen Ji Jaang	Kikanchou
	Cook	Chwu Shy	Kokku
	Crew	Chwan Yuan	Senin
	Crew list	Chwan Yuan Ming Dan	Senin meibo
	Engineer	Luen Ji Yuan	Kikanshi
	Fishing master	Yu Lhau Jaang	Sendoo or Gyorouchou
	Radio operator	Baw Wuh Yuan	Musen Kyokuchou
	Vessel owner	Chwan Juu	Senshu
	Chief Officer	Dah Fuh	Ktou koukaishi
	Bosun	Tafu	Kouban Chou
FISHING GEAR AND TERMS	Fish, fresh fish	Sheng Shian Yu	Seigyo
	Fish, canned fish	Guann Tour Yu	Sakana no Kanzume
	Fish scale	Liang yu Chyy	Uroko
	Weigh, to weigh	Chenq Jeng	Omosa o hakaru
	Weight	Jong Lianq	Omosa
	Basket	Kuang	Kago
	Buoy	Fwu Chyou	Tama
	Buoy line	Fwu Sherng	Ukenawa
	Hook	Gou	Turibari
	Mainline	Juu Sherng	Mikinawa
	Carrier boat	Yuun ban Chwan	Unpan sen
	Lifeboat	Jiow Sheng Tiing	Kyuumei booto
	Longliner	Woei Diaw Chwan	Haenawa sen
	Branch line	Yo Ka	Bun Sen or Shi Sen
Conveyer	Banyun Chi	Conveya	
NAUTICAL TERMS	Chart	Hae Twu	Kaizu
	Compass	Luo Parn, Hyy Nan Jen	Konpasu

	ENGLISH	TAIWANESE	JAPANESE
NAUTICAL TERMS cont.	Course	Hang Shianq	Shinro
	Depth	Shoei Shen	Suishin
	Island	Dao, Yeu, Sheau Dao	Shina
	Latitude	Woei Duh	Ido
	Longitude	Jing Duh	Keido
	Nautical mile	Hai Lii	Kairi or Mairu
	Radar	Lei Dar	Reida
	Satellite navigation	Wey Shing Dao Hang	Eisei kouhou
	Speed	Hang Suh, Suh Duh	Supiido
NUMBERS	Zero	Ling	Zero or rei
	One	I	Ichi
	Two	EII	Nii
	Three	San	San
	Four	Shy	Shi or Yan
	Five	Wuu	Go
	Six	Liow	Reku
	Seven	Chi	Shishi or Nana
	Eight	Ba	Hachi
	Nine	Jeou	Kyuu or ku
	Ten	Shyr	Juu
	Eleven	Shyr I	Juuichi
	Twelve	Shyr EII	Juuni
	Thirteen	Shyr San	Juusan
	Twenty	EII Shyr	Nijuu
	Forty	Shy Shyr	Yonjuu
	Fifty	Wuu Shyr	Gojuu
	One hundred	I Bae	Hyaku
	Two hundred	Leang Bae	Nihyaku
	One thousand	I Chian	Shen
Ten thousand	I Wann	Ichinan	

	ENGLISH	TAIWANESE	JAPANESE
TYPES OF FISH	Albacore	Charng Chyi Wei	Tombo of Binnaga Maguro
	Bigeye	Dah Muh Wei	Mebachi Maguro
	Skipjack tuna	Jeng Jian	Katsuo
	Yellowfin tuna	Hwang Chyi Wei	Kihada Maguro
	Black marlin	Bair Pyi Chyi Yu	Shirokawa Kajiki
	Blue marlin	Hei Pyi Chyi Yu	Kurokawa Kajiki
	Broadbill swordfish	Jiann Chyi Yu	Mekajiki
	Sailfish	Yeu Saan Chyi Yu	Bashokajiki
	Striped marlin	Horgng Row Chyi Yu	Makajiki
	Shortbill spearfish	Doan Woen Chyi Yu	Sugiyama
	Barracuda	Jin Suo, Jian, Suo	Onikamasu
	Mahi Mahi	Goei Tour Dau	Shiira
	Fish	Sheng Shian Yu	Sakana
	Porpoise	Hai Twen	Hanasaki no marui Iruka
	Turtle	Hae Guei	Kame
	Wahoo	Shyr Chyau	Sawara
	Sardine	Sha Ding	Iwashi
Squid	Suoo Goan	Ika	
WEATHER	Calm	Pyng Jinq De	Nagi
	Current	Hae Liou	Chouryuu/Kairyuu
	Moon, Full	Maan Yueh	Mangetsu
	Moon, New	Shin Yueh	Shingetsu
	Storm	Baw Feng Yeu	Arashi/shike
USEFUL PHRASES	Female	Tsyr Shing, Muu De	Mesu
	Male	Shyong Shing, Gong de	Osu
	Good morning	Tsau And	O-Ha-Yo-U
	How are you?	Ni Hao Ma?	Gokigen Ikaga?
	Come	Lai	Ku Ru
	Eat	Tsu Vand	Ta Be Ru

**USEFUL PHRASES
cont.**

ENGLISH	TAIWANESE	JAPANESE
Quick	Kuai Tien	Subayai or Ha Ya I
Give me	Na Ge Wo	Wa Ta Shi Ni Kure
Throw the line	Due Sen	Tsuri Ito Wo Nageru
Pull the line	La Sen	Tsuri Ito Wo Maku
You tie the rope	Ni Pang Gun	(Anata Ga) Himo Wo Musubu
You tie the branch line	Ni Bang Fen Sen	
Watchout	Siao Sin	Chui Shite/Kiwo Tsu Ke Te
Tangle	Da Chie	Motsure Ru/Karamu
Light	Kuang	Hi Ka Ri or Akari
Sleep	Sui Tsau	Suimin
Water	Shui Chiao	Mizu
I'm tired	Hen Ley	Watashi Wa Tsukare Te Imasu
Headache	Tho Tong	Zu Tsu U
Hey! this is the fish	Shopai	Oi Ko Re Wa Sakana Da
Get the hook	Na Kau Wa	Hook Wo Kakeru
Coil	Go Topi	(Guru Guru) Maku
Thank you	Shieh Shieh	Ariga To U
Please	Chin	One Gai Shi Ma Su
Yes	Toi	Hai
No	Buh	lie
I feel sick	Wo Tse Te Sem Pin	Wa Ta Shi Wa Kibun Ga Warui Desu
Painful	Hen Thong	Itai or Kurushii
Yes, I understand	Wo Tsu Tau	Hai, Wa Kari Mashi Ta
This person	Tsaka Ran	Kono Hito

PARTS OF A FISHING VESSEL (PURSE SEINE)

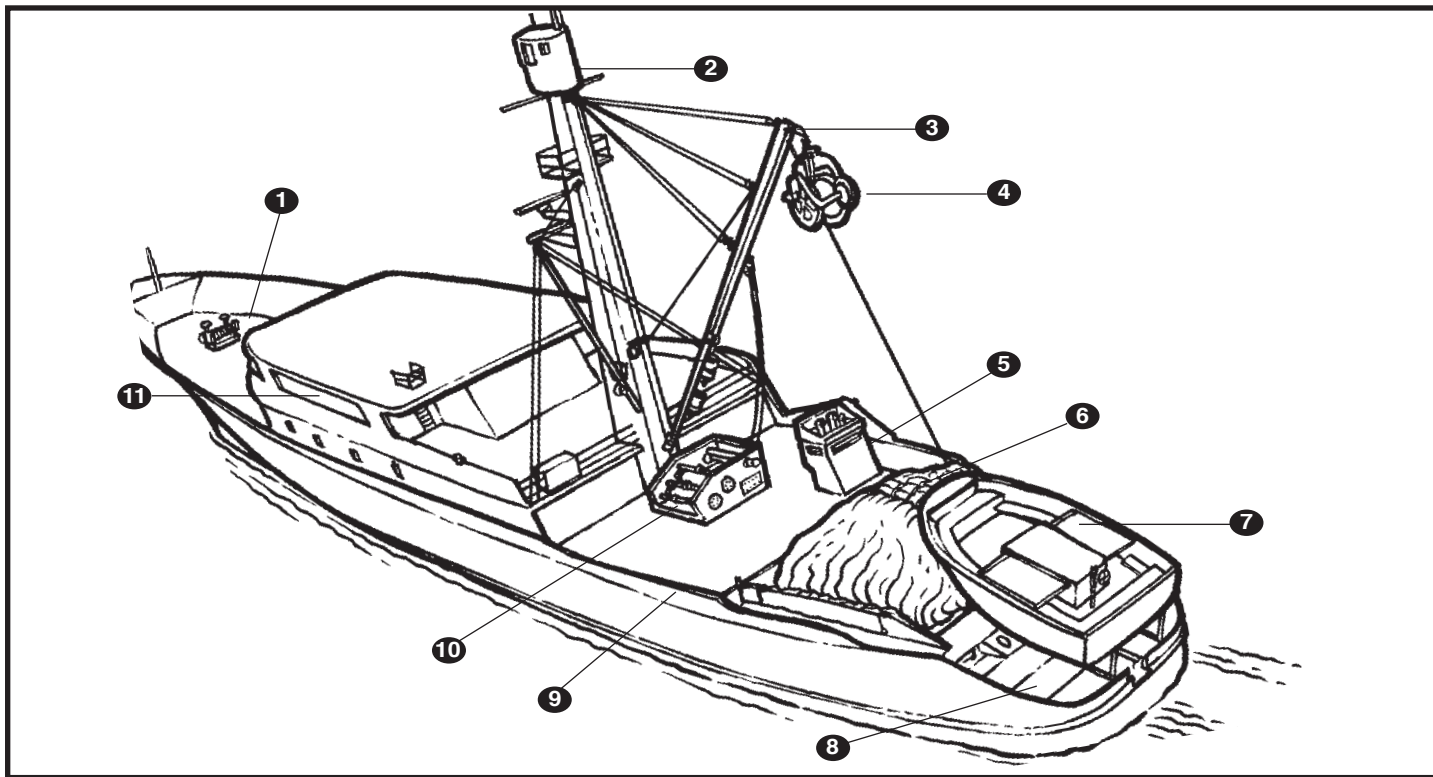

1 Anchor winch

2 Crow's nest

3 Boom

4 Power Block

5 Control station

6 Purse seine net

7 Skiff

8 Ramp

9 Bulwark

10 Winch

11 Wheelhouse

PARTS OF A FISHING VESSEL (LONGLINER)

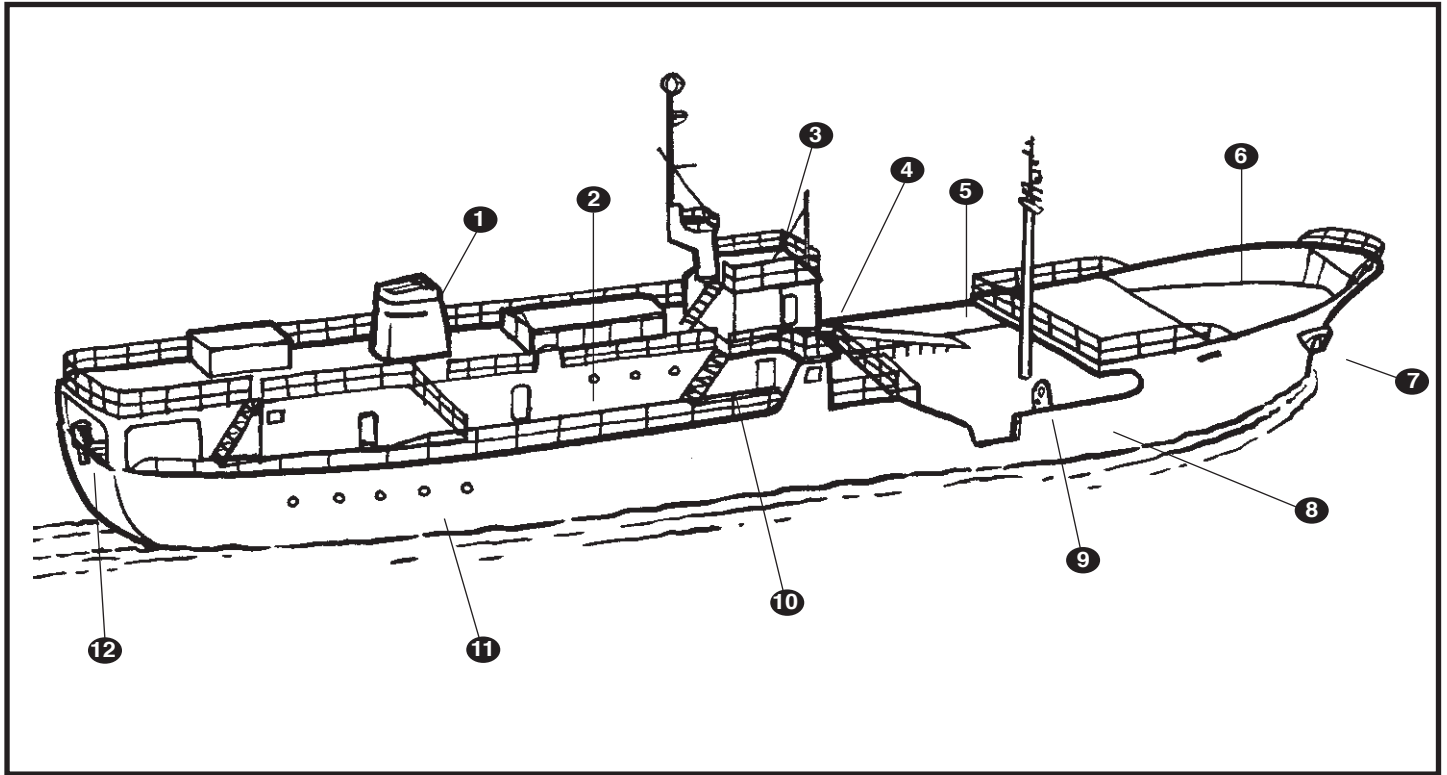

- | | | | |
|---------------|---------------------------|----------------------------------|------------------|
| 1 Funnel | 2 Accommodation | 3 Flying bridge or monkey island | 4 Wheelhouse |
| 5 Port side | 6 Fore castle (Fo'c's'le) | 7 Anchor | 8 Starboard side |
| 9 Line hauler | 10 Companion way | 11 Portholes | 12 Line setter |

PARTS OF A FISHING VESSEL

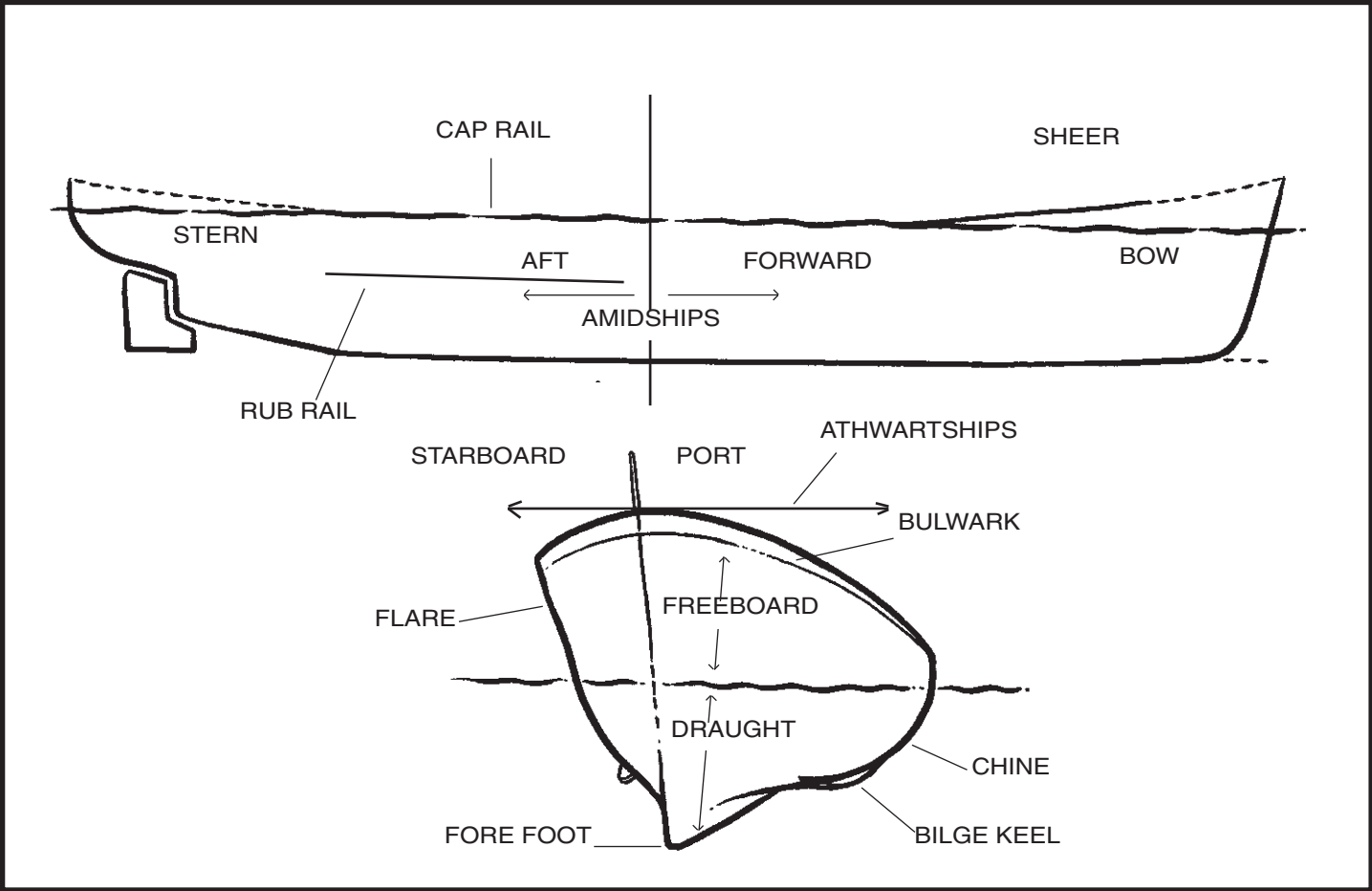

PARTS OF AN INFLATABLE LIFE RAFT

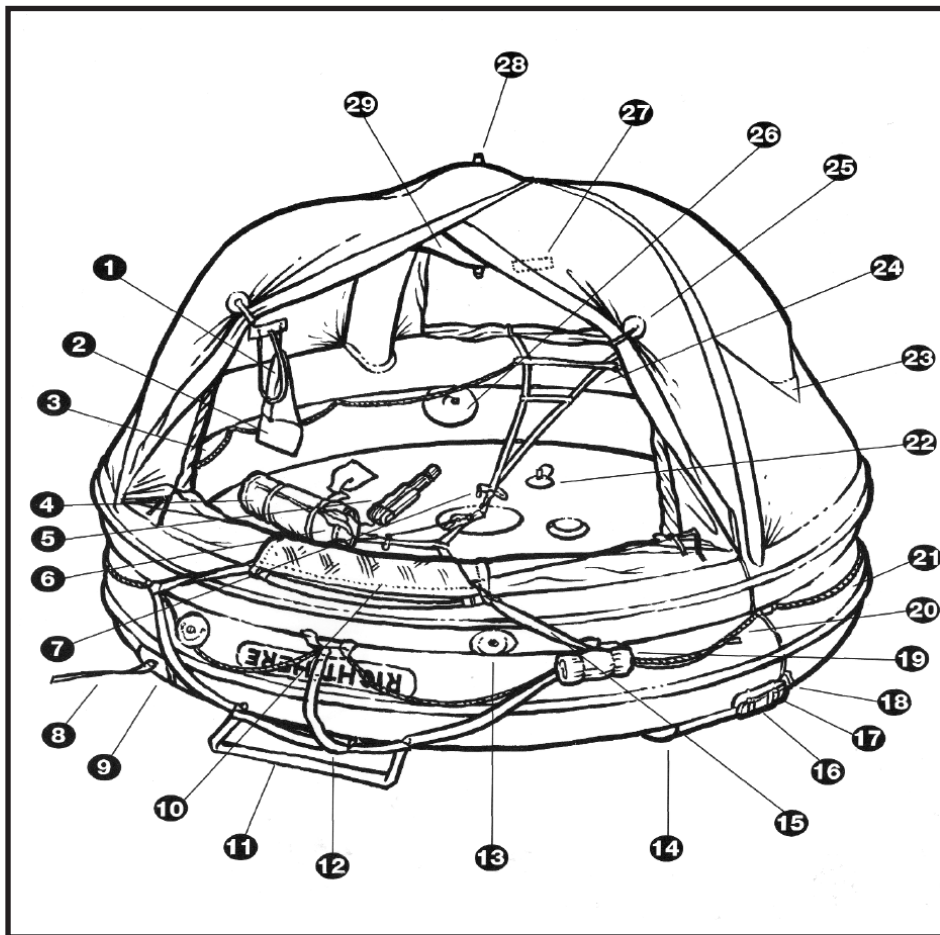

- 1 Rain catchment tube and bung
- 2 Canopy instruction label and bag (liferaft handbook inside bag)
- 3 Internal lifeline
- 4 Emergency pack
- 5 Paddles
- 6 Lanyard
- 7 Quick release for hauling-in line
- 8 Painter
- 9 Painter patch
- 10 Window in inner door
- 11 Boarding ladder & righting strap
- 12 Inflation hose
- 13 Deflation plug
- 14 Water stabilising pocket
- 15 Canopy furling tapes
- 16 Sea light cell
- 17 Plug
- 18 Cell pocket
- 19 Drogue
- 20 Drogue line
- 21 External life line
- 22 Floor inflation valve
- 23 Rain catchment
- 24 Hauling-in line
- 25 Canopy furling tapes
- 26 Safety and topping-up valve
- 27 Knife (stuck on Arch tube)
- 28 External light
- 29 Internal light

LIFE RAFT EQUIPMENT

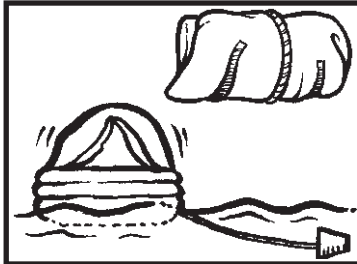

Sea anchors



Buoyant bailer

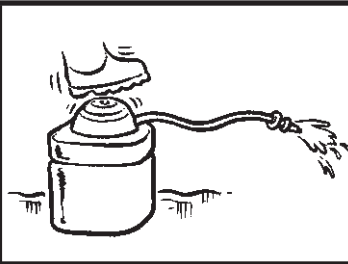

Pump or bellows

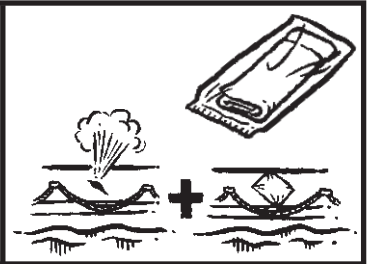

Puncture repair kit

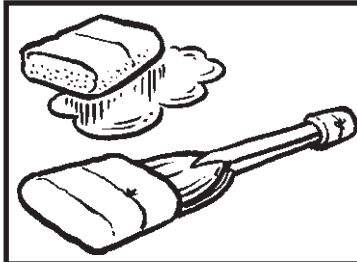

Paddles & sponges

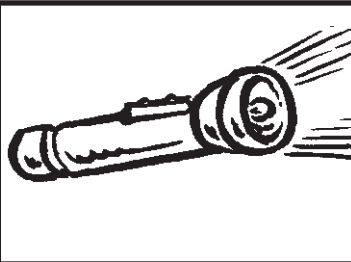

Torch



Whistle

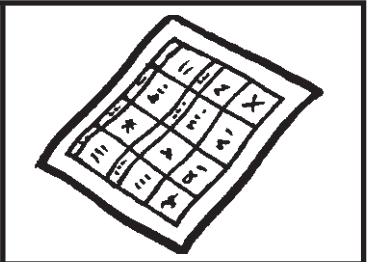

Rescue signal table

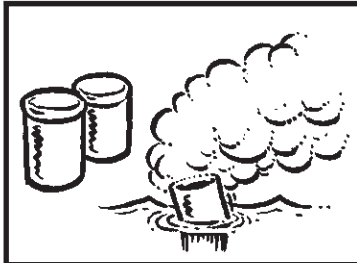

Buoyant smoke signals

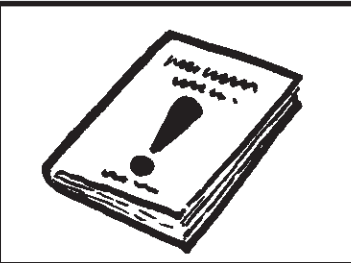

Instructions for immediate use



Thermal protective aid



Sea-sickness bag

LIFE RAFT EQUIPMENT

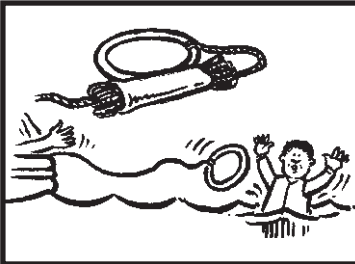

Buoyant rescue quilt

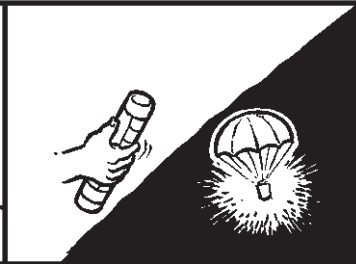

Parachute distress rockets



Hand flares

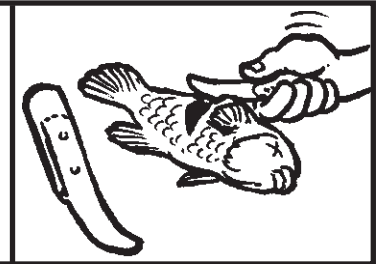

Safety knife

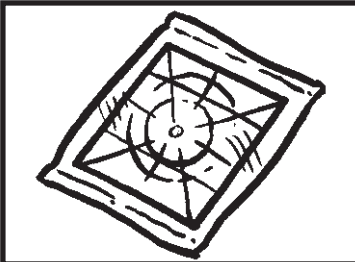

Heliograph

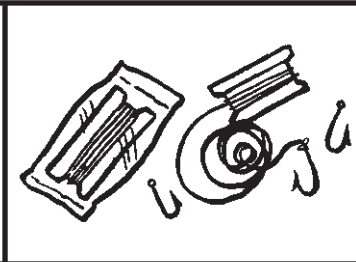

Fishing kit

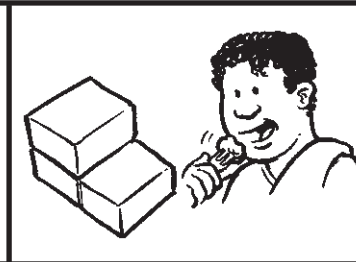

Food ration



Water ration

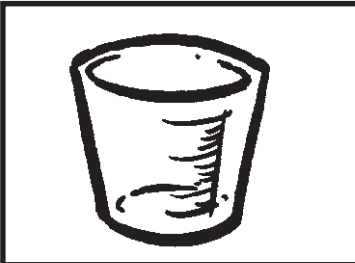

Graduated drinking vessel

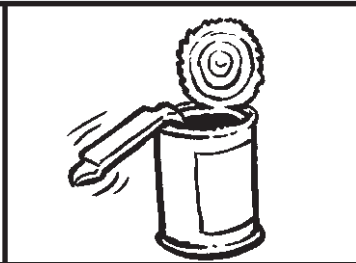

Tin openers

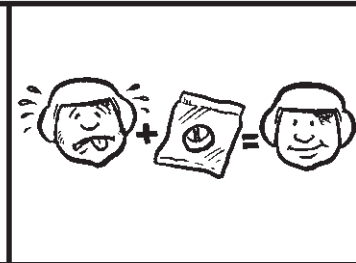

Sea-sickness tablets

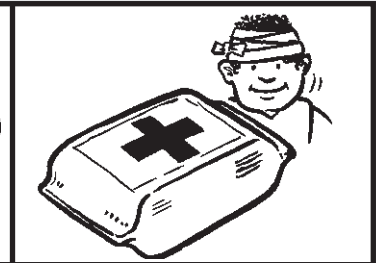

First aid outfit

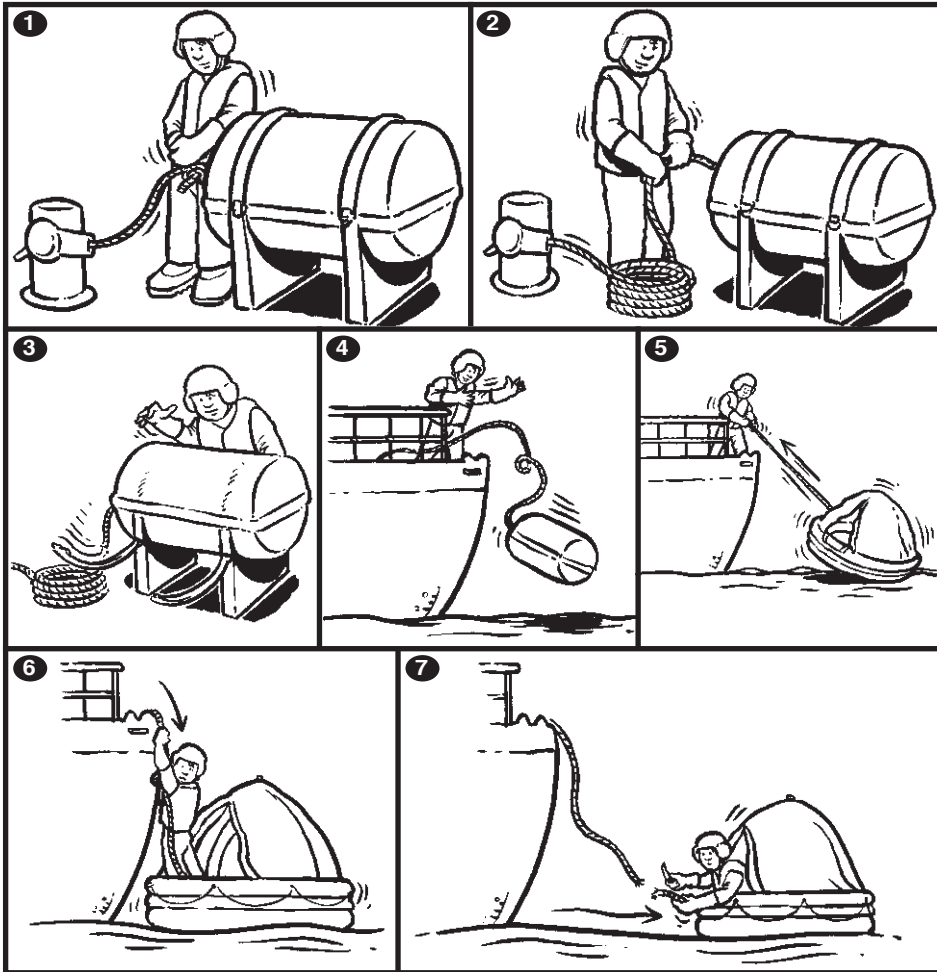

LAUNCHING THE LIFE RAFT

- 1** Check painter is tied somewhere secure
- 2** Pull out sufficient line to reach ship's side
- 3** Release senhouse slip
- 4** Carry to side of vessel, check for obstructions and throw in
- 5** Pull painter to inflate raft
- 6** Pull raft alongside and climb in without getting wet
- 7** If necessary, cut painter with knife kept in arch and move away

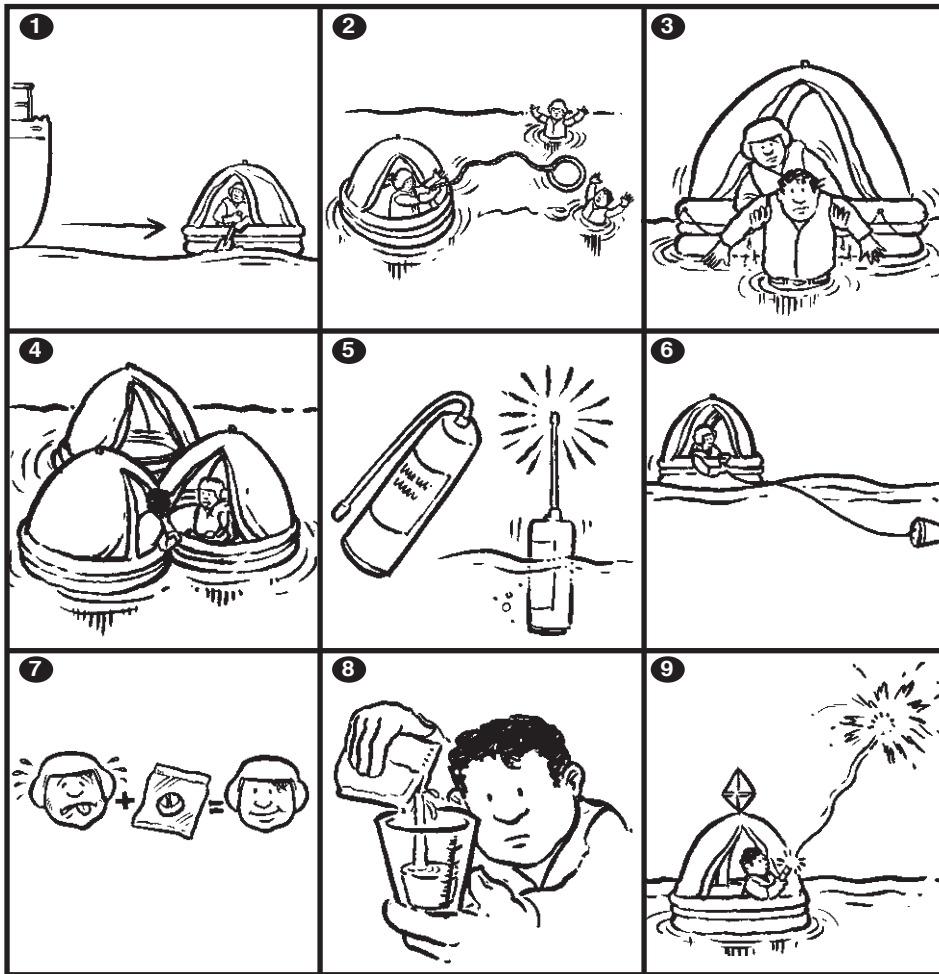

SURVIVAL AFTER LAUNCHING

- 1 Move away from sinking ship by paddling or by using sea anchor rolled into a ball and thrown in direction you want to go. Once clear, wind will blow you faster
- 2 Look for survivors. Use quit to reach them
- 3 Lift survivors into raft from under arms
- 4 Keep life rafts together
- 5 Set off EPIRB
- 6 Set the sea anchor
- 7 Take sea-sickness tablets
- 8 Collect and ration fresh water
- 9 Use flares and radar reflector to aid detection

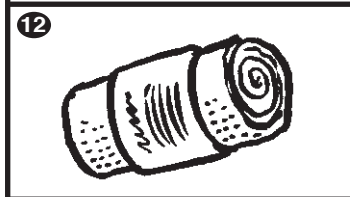
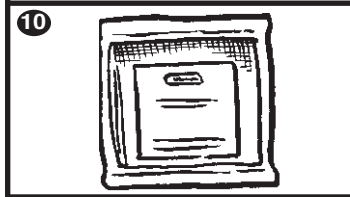
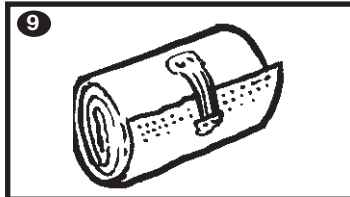
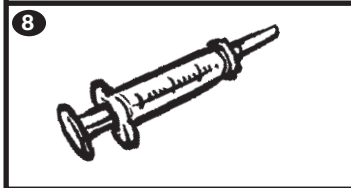
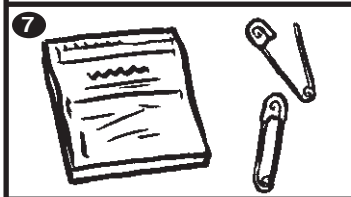
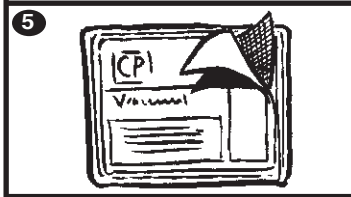
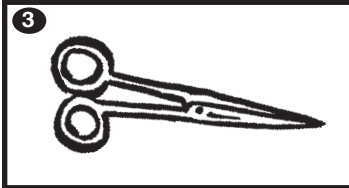
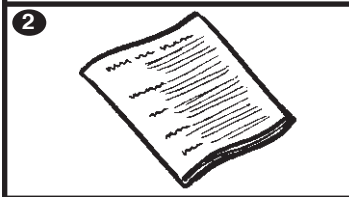
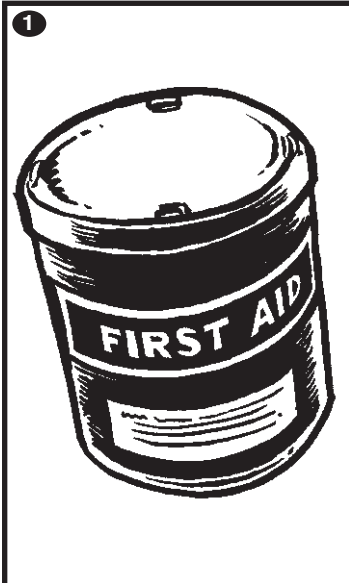

FIRST AID EQUIPMENT

- 1 First aid container
- 2 First aid instructions
- 3 Stainless scissors
- 4 Painkillers
- 5 Paraffin gauze dressing
- 6 Antibiotics
- 7 Stainless safety pins
- 8 Morphine or equivalent
- 9 Standard dressing
- 10 Triangular bandage
- 11 Self-adhesive waterproof dressing
- 12 Open weave bandage
- 13 Antiseptic cream

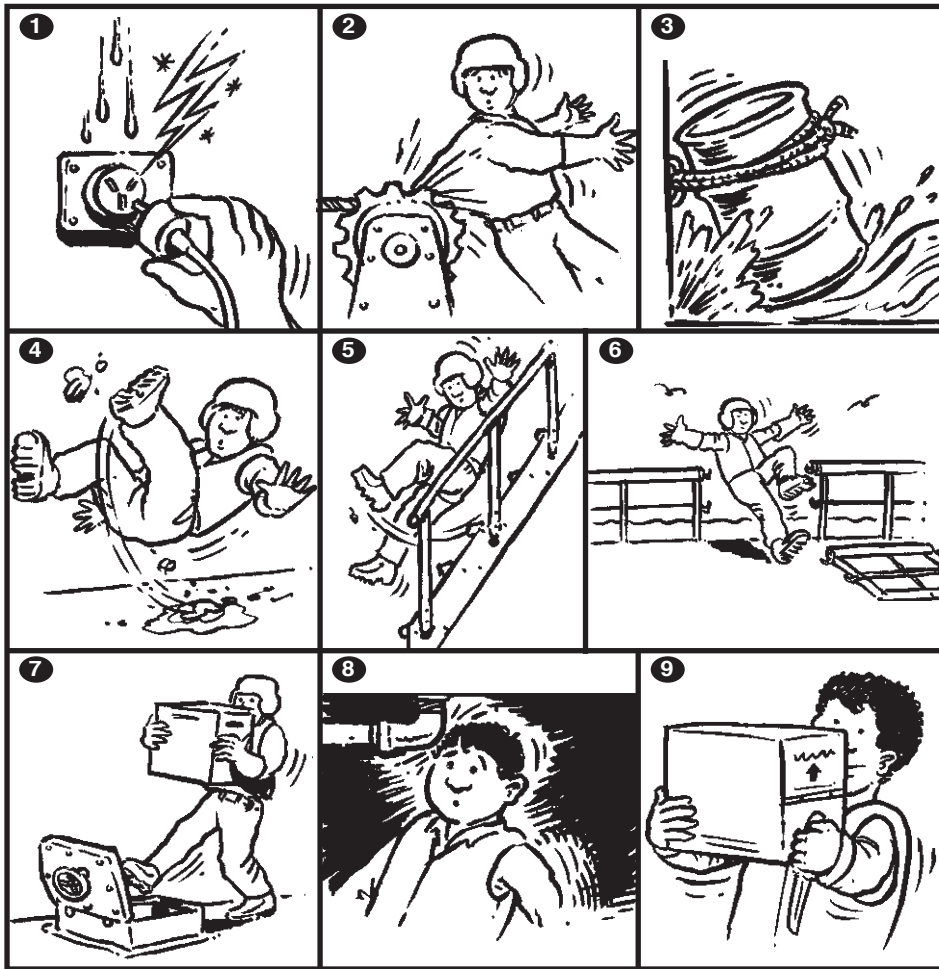

SAFETY ON DECK

Watch out for:

- 1** Electricity dangers
- 2** Loose clothing
- 3** Inadequate lashings
- 4** Slipping on deck
- 5** Slipping on ladders and stairs
- 6** Portable parts of railings missing
- 7** Open manholes
- 8** Bad lighting
- 9** Carrying knives when doing other work

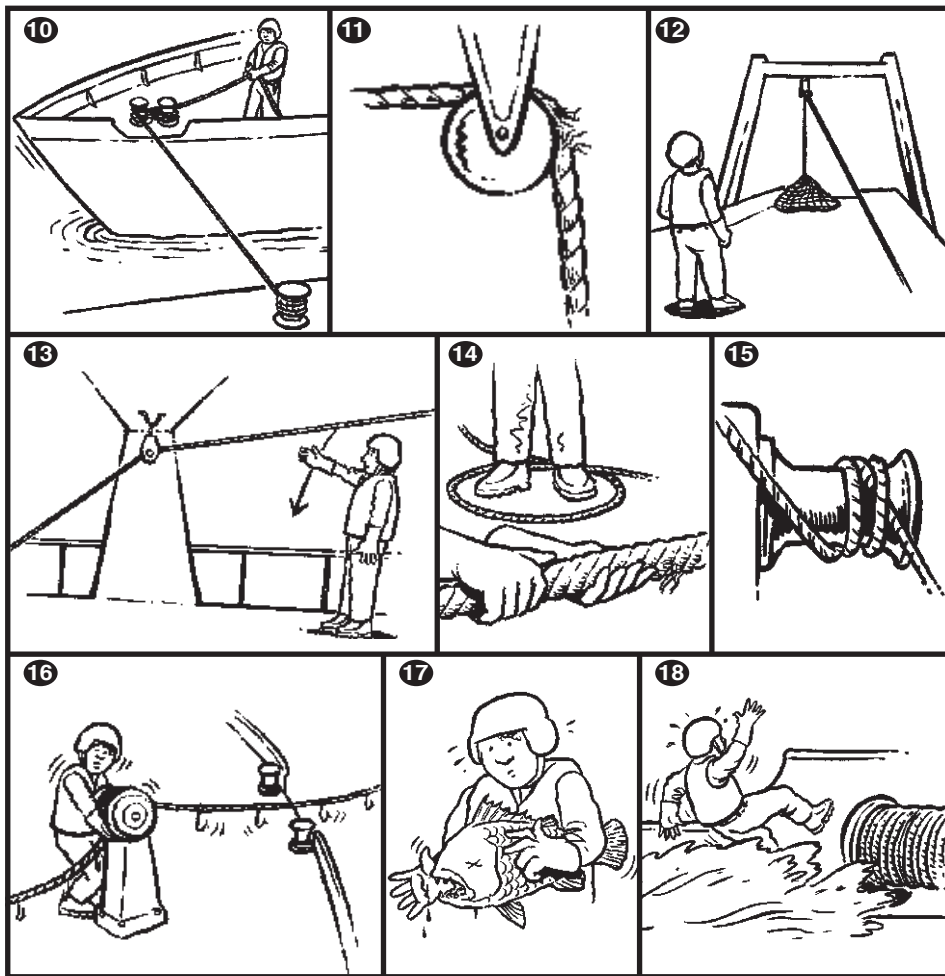

SAFETY ON DECK

Watch out for:

- 10 Spring lines breaking when mooring
- 11 Weakened wires
- 12 Blocks failing through wear
- 13 Danger areas where you might get hit if line or gear breaks
- 14 Getting caught in the bight of a rope; sprags
- 15 Riding turns
- 16 Line hauler
- 17 Teeth and spikes when handling fish
- 18 Water on deck in rough weather

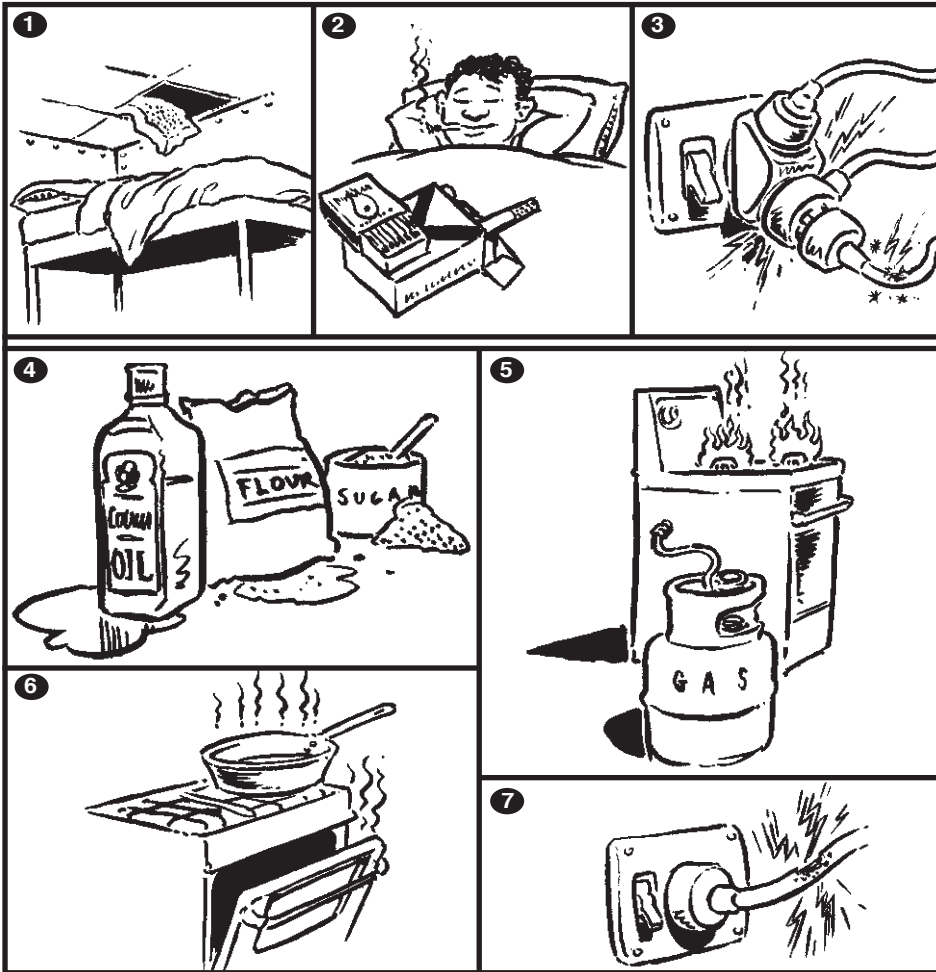

CAUSES OF FIRE

Fire Hazards in Accommodation

- ① Combustible materials
- ② Matches and smoking
- ③ Defective electrical connections

Fire Hazards in Galley

- ④ Combustible materials
- ⑤ Oil or gas stoves (gas bottles)
- ⑥ Hot surfaces, ovens, frying pans, flues
- ⑦ Defective electrical connections

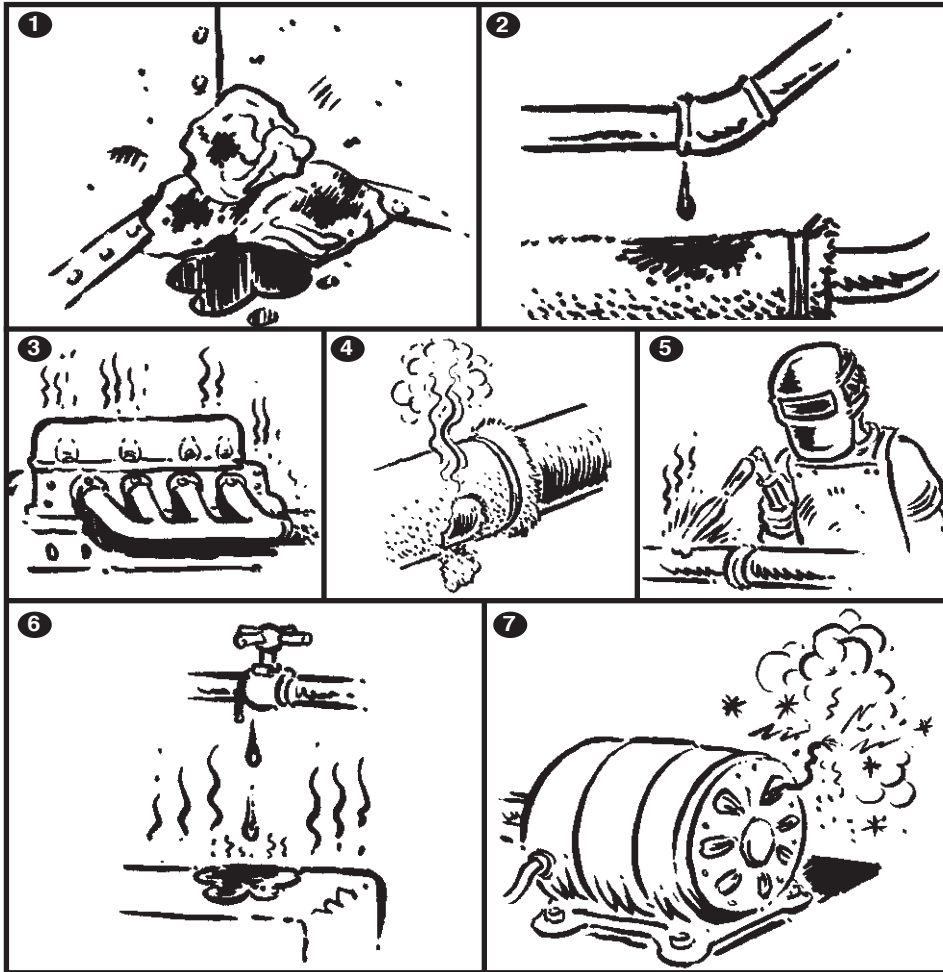

CAUSES OF FIRE

Fire Hazards in the Engine Room

- 1** Poor housekeeping
- 2** Oil leaks and oil soaking into exhaust lagging
- 3** Hot surfaces, eg exhaust pipes, engine parts overheating
- 4** Defective exhaust lagging
- 5** Welding or metal cutting
- 6** Auto ignition, eg oil dripping on a hot surface
- 7** Electrical fire (or smoke)



FIRE FIGHTING PRINCIPLES AND ORGANISATION

- 1 THE FIRE TRIANGLE**
Material + Oxygen + Heat

TO EXTINGUISH THE FIRE

- 2** Remove heat
OR
3 Remove oxygen
OR
4 Remove material

ALSO

- 5** Have a muster list and post fire plans
6 On discovering a fire, first raise the alarm
7 If a small fire, tackle it quickly by using the right appliance

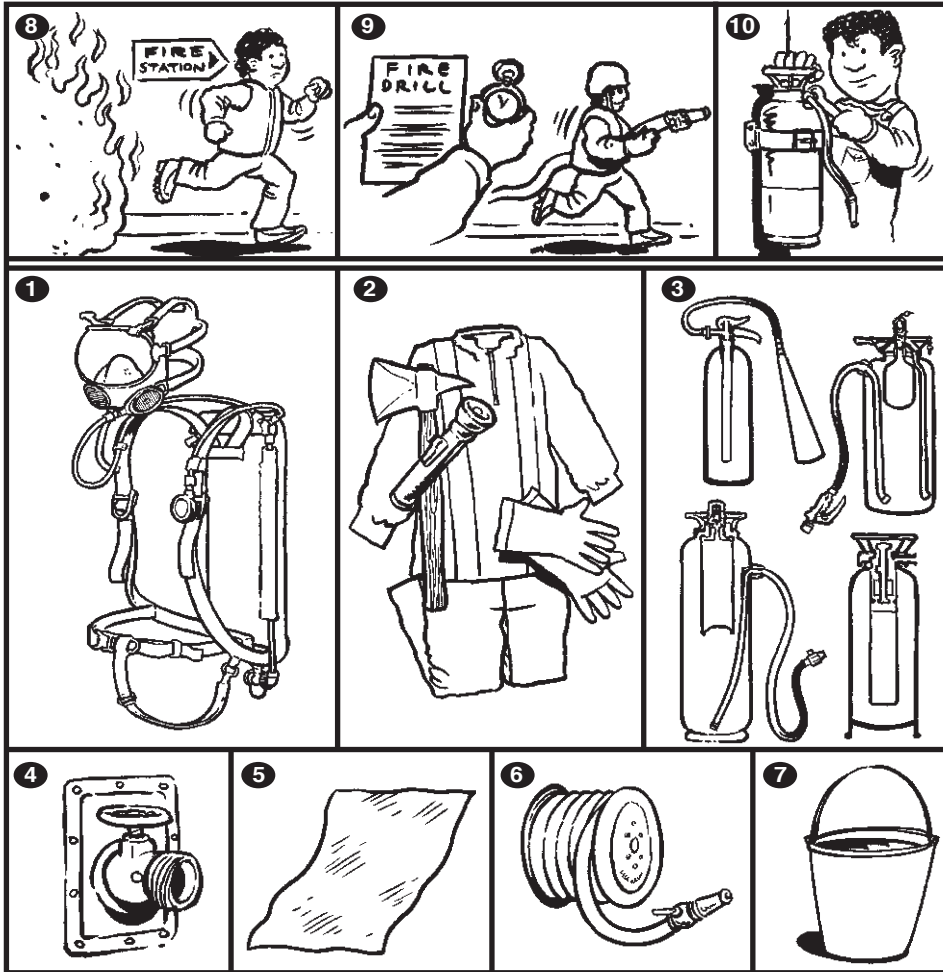

FIRE FIGHTING PRINCIPLES AND ORGANISATION

- 8 If it is a big fire, go to fire stations
- 9 Have fire drills often
- 10 Maintain fire-fighting equipment

FIRE FIGHTING EQUIPMENT

- 1 Breathing apparatus
- 2 Fireman's outfit, axe, torch
- 3 Portable extinguishers
- 4 Fire hydrant
- 5 Fire blanket
- 6 Fire hose
- 7 Fire bucket

IF YOU FISH IN TROUBLED WATERS - USE CONDOMS

Community Health Programme. HIV/AIDS & STD Project.

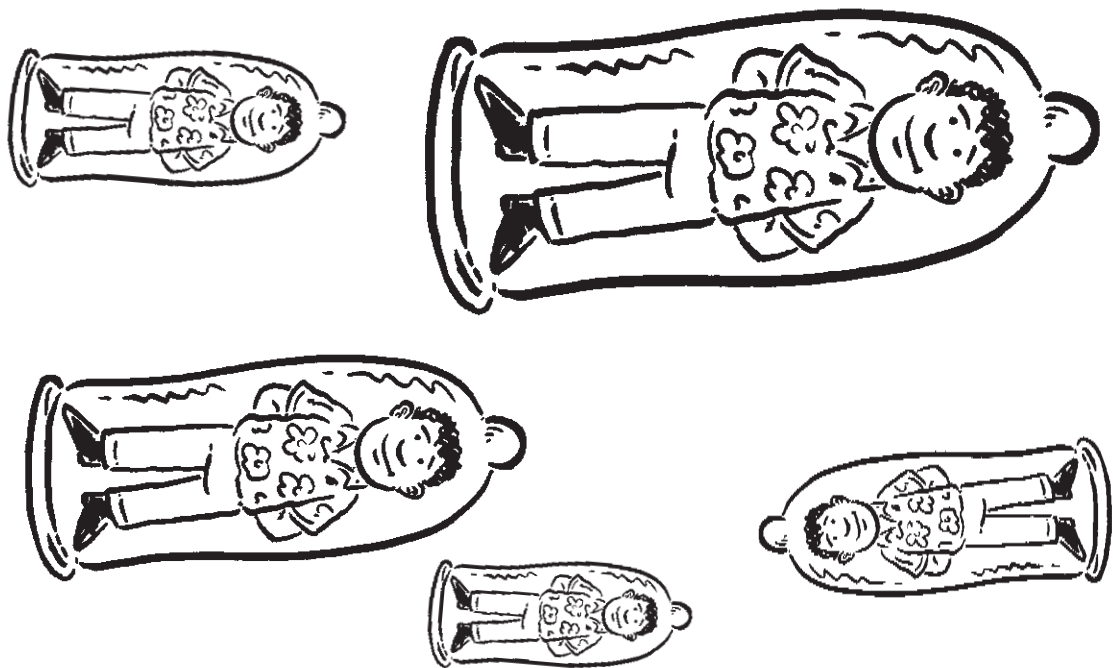

SECRETARIAT OF THE PACIFIC COMMUNITY

Contact: HIV/AIDS & STD Project, SPC, BP D5, 98848 Noumea Cedex, New Caledonia.

Fax: +687 263818, email: spc@spc.int

The design above is adapted from a postcard produced by Family Planning New South Wales

DO NOT POLLUTE THE ENVIRONMENT AS IT WILL ADVERSELY AFFECT THE WELFARE OF ALL LIVING THINGS - INCLUDING YOURSELF

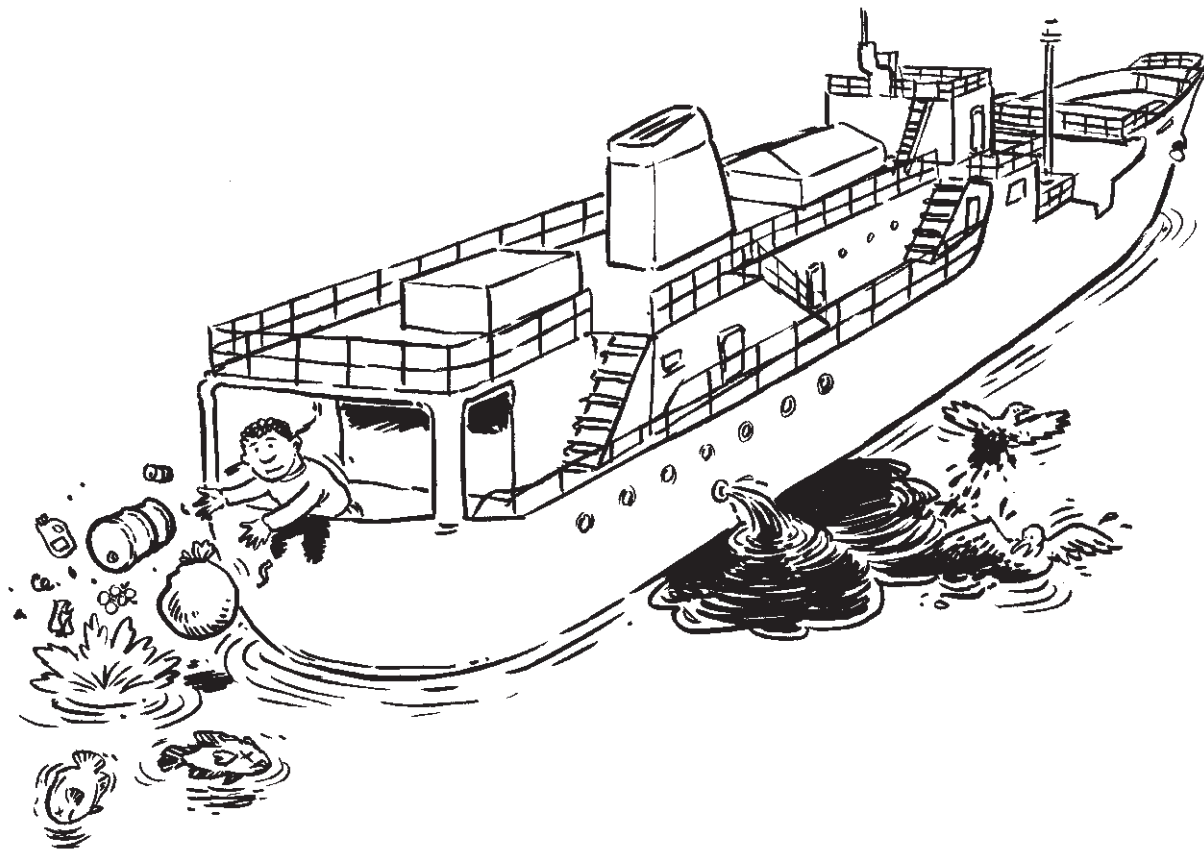

'Pacific Community' is the new name of the South Pacific Commission (SPC). The new name became official on 6 February 1998, in commemoration of the 51st anniversary of the 1947 Canberra Agreement which originally established the SPC.

The change of name does not alter all the established SPC acronyms, but their meanings are modified.

'Pacific Community' applies to the total organisation, i.e. the member governments, the Conference, the CRGA and the Secretariat. **'Secretariat of the Pacific Community (SPC)'** refers to those who provide the service to members of the Community.

