



*REef REsources Assessment Tools*

# UNDERWATER VISUAL FISH CENSUS SURVEYS

## ***Proper use and implementation***

Pierre Labrosse, SPC Principal Reef Fisheries Scientist, Noumea

Michel Kulbicki, IRD Research Officer, Noumea

Jocelyne Ferraris, IRD Research Officer, Noumea



Secretariat of the Pacific Community

Noumea, New Caledonia

2002

This document has been produced with the financial assistance of the European Community and France.

The views expressed herein are those of SPC and can therefore in no way be taken to reflect the official opinion of the European Community and France.





© Copyright, Secretariat of the Pacific Community (SPC), 2002

Original text: French

Secretariat of the Pacific Community cataloguing-in-publication data

Labrosse, Pierre

Underwater visual fish census surveys: Proper use and implementation by  
Pierre Labrosse, Michel Kulbicki and Jocelyne Ferraris

(REAT: Reef resources assessment tools)

1. Fish stock assessment - Oceania - Handbooks, manuals, etc
2. Diving--Handbooks, manuals, etc

1. Title 2. Secretariat of the Pacific Community 3. Series 4. Kulbicki, Michel 5.  
Ferraris, Jocelyne

ISBN 982-203-878-X

AACR2

Secretariat of the Pacific Community  
BP D5

98848 Noumea Cedex

New Caledonia

Telephone: +687 26 20 00

Facsimile: +687 26 38 18

Email: [spc@spc.int](mailto:spc@spc.int)

<http://www.spc.int>

Prepared for publication and printed at the Secretariat of the Pacific Community  
Noumea, New Caledonia



# TABLE OF CONTENTS

ACKNOWLEDGEMENTS .....	V
FOREWORD .....	VI
I - INTRODUCTION .....	1
I.1 - Why assess resources? Assessment and management .....	1
I.2 - What kinds of assessment methods are available to fisheries management personnel? Role of underwater visual census surveys .....	2
II - BACKGROUND INFORMATION ON UNDERWATER VISUAL FISH CENSUS SURVEYS .....	5
II.1 - Basic principles .....	5
II.2 - Which types of data for exactly what kind of information? .....	6
II.2.1 - Status of fish stocks .....	7
II.2.2 - Environmental factors .....	10
II.3 - Sources of error .....	11
II.3.1 - Sources of error due to the diver .....	11
II.3.2 - Sources of error due to fish .....	13
II.3.3 - Sources of error due to sampling .....	13
II.4 - How to limit sources of error .....	16
II.4.1 - Observer training .....	16
II.4.2 - Basic rules for designing sampling surveys and selecting transects or stationary points .....	20



III - SETTING UP VARIABLE DISTANCE UNDERWATER VISUAL FISH CENSUS SURVEYS .....	26
III.1 - Review of safety rules for diving work .....	26
III.2 - Equipment .....	28
III.3 - Transects .....	29
III.4 - Stationary points .....	33
IV - USING THE DATA COLLECTED .....	37
IV.1 - Entering and formatting data .....	37
IV.2 - Calculating densities, biomass and stock (numeric and weighted) .....	37
IV.3 - Calculating the accuracy of density and biomass estimates .....	40
IV.4 - Mean composition of substrate and living organism cover .....	42
IV.5 - Initial analysis of results .....	42
IV.5.1 - <i>Comparing results</i> .....	42
IV.5.2 - <i>Correlations between fish and environmental factors</i> .....	45
V - CONCLUSIONS .....	47
APPENDICES .....	49
Appendix 1 - Outlines of the major fish families that are of food and/or commercial interest .....	49
Appendix 2 - List of fish species that are of food and/or commercial interest .....	50
Appendix 3 - Fish census record sheet .....	51
Appendix 4 - Environmental factors record sheet .....	52
TO FIND OUT MORE ... ..	53



# ACKNOWLEDGEMENTS

This handbook is the result of a team effort and so we would like to thank all those who contributed to it.

The SPC Publications Section played a major role in this work. Our warm thanks to Muriel Borderie who handled the lay out, Jipé Le Bars who designed its illustrations and Kim Des Rochers who edited the manuscript.

We should not overlook the proof-readers, who made significant improvements to the manuscript: Marie-Thérèse Bui, Ben Ponia and Sheryl Mellor and Gilles Kaboha who translated the handbook into English.

Finally, we would like to express our special thanks to Mireille Harmelin-Vivien who gave us permission to take our inspiration from a document about underwater visual census surveys published in 1985 (see 'To Find Out More...' section).

This document is dedicated to Pierre Thollot.





# FOREWORD

This document is the first in a series of publications that respond to requests from fishery services in Pacific Island countries and territories for tools and practical advice on implementing reef fish resource assessment methods. This series is open to all authors and is part of a process of standardising assessment and monitoring methods for reef and lagoon fishery resources and activities at the regional level.

A variety of manuals and publications have dealt with underwater visual census survey methods and their applications, as well as data processing and analysis. For this reason, this handbook will simply review their major aspects. Its main purpose is to introduce an underwater visual census survey method that has been developed and enhanced by the French Institute of Research for Development (IRD). This method has been tested in a number of different locations, including New Caledonia, Tonga and Fiji Islands. It can also be adapted for and has applications in the assessment of invertebrate resources. This booklet is a companion document to the ReACT-FishUVC software, which makes it possible to both enter the data acquired during surveys using this method and carry out initial calculations on them.



# 1 - INTRODUCTION

## ***I.1 – Why assess resources? Assessment and management***

A steady rise in many Pacific Island populations, particularly those in urban areas and capitals, is causing an ever-increasing demand for protein. Given the limited land available to small islands and the developing nature of most island economies, it is unlikely that this nutritional demand will be satisfied by either agriculture or imports in the near future. Pressure on fisheries, especially nearshore reef fisheries, will inevitably increase.

In addition to local needs, there is a growing demand in Asia and other areas for speciality reef fishery products, and Pacific Island exporters are finding new markets on a regular basis. One such example is the market for live reef food and aquarium fish. As with all fishing, exploitation has an effect on the reef ecosystem, but the potential risks from this particular fishery are quite high. This market demands species that are, for the

most part, fragile due to their scarcity or their biological and ecological characteristics. Due to their high market value, reef fisheries are also prone to destructive practices (e.g. cyanide or dynamite fishing), which endanger fishermen, coral reefs and their inhabitants.

Despite the risks inherent in such activities, reef resources represent a source of nutrition and income and a significant development opportunity for Pacific Island countries. These communities and their governments must try to balance conflicting demands, development, and maintain ecological integrity; however, available information and resources are still insufficient.

Managing means looking ahead. Managing also involves adapting existing resources to meet the objectives set for the medium- or long-term (i.e. beyond three years). Good management practices are based on having as much information as possible about the context and environment the practices will be applied to. For that reason, data collection



methods that make it possible to describe as closely as possible the situation at a given point in time, must be determined. Ideally, as part of the precautionary approach, management plans should be designed from baseline information and include monitoring measures so that action can be taken whenever human-induced changes become noticeable.

**This information should include:**

- ▶ estimates of total and exploitable fishery stocks;
- ▶ analysis of the main structures of these populations (size, trophic and population structures);
- ▶ the health status of the reef and associated ecosystems; and
- ▶ a good grasp of the dynamics of the fishery.

Such information should make it possible to adapt management measures to each new situation encountered.

Acquiring this information involves:

- 1) designing sampling strategies that provide a reliable picture of the resource for an acceptable level of effort both in terms of cost and time; and
- 2) implementing adequately tested methods to provide high quality information that can be compared in both space and time, thereby allowing reliable measurement of any changes that occur.

***1.2 – What kinds of assessment methods are available to fisheries management personnel? Role of underwater visual census surveys***

Many types of reef and lagoon resource assessment methods exist. None of them are perfect and all have advantages and disadvantages. They all have one point in common: they are based on the study of a section or subgroup of the population in question. For that reason, they require the use of sampling techniques, which can be divided into three categories: capture methods, mixed methods and non-capture methods.





**Capture methods** mainly involve recording information on fish captured in traps (and, more generally, with bait), in nets by trawling, and with lines. These methods are based on an analysis of the catch per unit of effort (CPUE), which is considered to be an index of the study population's density. Capture methods can be used at any time and at considerable depths. Moreover, they can be implemented on a wide scale and at low cost using scientifically unskilled staff. On the other hand, gear design and selectivity, the effect of baits, and the capturability of certain species are all factors that have an effect on the comprehensiveness and accuracy of these methods, which remain low to moderate. One exception, however, is fishing with explosives or poisons (e.g. rotenone), which gives comprehensive results, particularly in terms of species richness, but whose destructive effects are a major disadvantage, particularly for repeated sampling.

**'Mixed' methods** are somewhere between capture methods and non-cap-

ture methods. In particular, they include capture-tag-recapture methods, which are difficult to assess qualitatively or quantitatively. On the other hand, mixed methods are very effective in determining age, growth, movement and behaviour in reef fish populations.

Due to hyperdiversity<sup>1</sup> and the wide range of reef and lagoon environments, capture methods are often inadequate. The most effective capture method is destructive and/or disruptive (e.g. dynamite, rotenone), but can occasionally be useful for calibrating methods based on observation. This justifies the development of true **non-capture or 'fishery independent' methods**, which include visual censuses and hydroacoustic techniques. These two techniques are especially useful for assessing pelagic or semi-pelagic fish stocks comprising a limited number of species. They are, however, poorly adapted to highly diverse benthic populations, although certain applications are possible,



<sup>1</sup> The term 'hyperdiversity' refers not only to very high species diversity, but also to very high diversity of biotopes, ecological niches, behaviours, genomes and uses.

particularly for behavioural studies. The clarity of tropical water is a factor that has contributed to the growing use of on-site visual assessments. These methods are also more comprehensive, more accurate and non-destructive. Underwater visual censuses (UVC) were first used to

measure fish and invertebrate abundances. They were then used to study the dynamics of exploited and unexploited populations, and the ecology and management of natural resources and environments. The use of UVC requires qualified and trained staff.

### ***Summary of the various sampling method categories***

Sampling techniques	Quality of data				Needs	
	Comprehensiveness	Accuracy	Coverage	Bias linked to life cycle	Staff training	Costs
<b>Capture</b>	Low*	Low to moderate	High	Yes	Low	Low
<b>Mixed (combined)</b>	Low	Moderate	Moderate	Yes	High	High
<b>Non-capture</b>	High	High	Low	No	High	Moderate

\* except for explosives and poisons



## II - BACKGROUND INFORMATION ON UNDERWATER VISUAL FISH CENSUS SURVEYS

### ***II.1 – Basic principles***

Underwater visual census methods are based on on-site visual counts of organisms. Census methods can be done in a variety of ways, the most common of which is by either snorkelling or scuba diving. In certain instances, cameras, video cameras or submersible gear can be used to get around the constraints linked to sampling by divers.

Use of underwater visual censuses is limited by:

1. visibility, which must be adequate to record useful information. If the water is too turbid (e.g. around rivers estuaries, mangroves, mining areas, etc.) and/or there is minimum light (e.g. during night diving, or limited light penetration into the water), this method is difficult, if not impossible, to use;
2. the state of the ocean and, more generally, weather conditions; and
3. the diver's physiology in the aquatic environment, in the case of snorkelling. In those cases when they are not able to conduct the census from the surface, observers are limited by their inability to remain underwater without breathing. Use of scuba equipment involves depth and time limits that cannot be surpassed without endangering the diver. Divers are also limited by their inability to withstand cold and fatigue.

For all these reasons, underwater visual censuses involving snorkelling or scuba are best carried out in clear, calm and shallow water (generally between the surface and a depth of 20 m).

Censuses can be conducted in three ways: along random paths (chosen by chance), using quadrats (grids moved along a transect by divers) or transects, or from stationary points. Only the latter two fish





census methods are discussed in this manual; the other method is rarely used and can generate other problems related to resource assessments.

A **transect** is a rectangular area whose length and width is clearly defined. The census, or count, is carried out within the boundaries of the transect, which is generally denoted out by a flexible graduated tape measure, which is rolled out on the seafloor. Counting is conducted on either side of this tape within a set area. This is one of the most commonly used methods, and is well suited to population studies, particularly those assessing fisheries resources for commercial or food purposes.

Censuses can also be done by counting from **stationary points**. In this case, the observer begins counting from a determined point while slowly turning in a circle. This method is quicker than laying a transect. It is particularly recommended for studying a species or small group of species, especially in very heterogeneous environments, and for isolated complex structures or large-size formations (coral heads, large boulders).

## ***II.2 – Which types of data for exactly what kind of information?***

The data collected and the sampling strategy used determine the type of information that can be obtained. This can differ according to whether a qualitative or quantitative inventory of fisheries resources is required.

Information of interest to reef fisheries management can be divided into two categories.

1. The state and size of food and/or commercial fish stocks, or those of interest due to their ecological aspects (biological indicator). This includes analysis of the populations' structure.
2. The state of the reef habitat, which supports the resource, including associated living organisms.

This information is mainly designed to:

1. make it possible to carry out comparisons in space (resource location and determination of its characteristics depending on site, biotope or zones subject to unequal fishing pressures) and/or time (resource monitoring,



changing trends and detecting changes); and

2. determine correlations between the resource and its environment.

### II.2.1 – Status of fish stocks<sup>2</sup>

#### *a – Identifying and counting species*

Identifying and counting species provides an estimate of **species richness** (i.e. the number of species), particularly for environmental inventories. This can be limited to a sector of the population for food and/or commercial purposes or else can be conducted from an ecological point of view. This is an important parameter to consider. Any appreciable attack on the environment, such as the destruction of coral, usually brings about a decrease in species richness, which is an indication of biodiversity (i.e. number of species, and their percentage in the population).

#### *b – Counting individuals*

Individuals are counted to estimate **abundance** (number of fish) and **density** (the number of fish per surface area unit) (e.g. individuals per square metre). Abundance and density are factors that can be affected

by fishing activities and so, in certain cases, are a reflection of fishing intensity.

Counting can be conducted in a fixed rectangular area (transect) or a circular area (stationary points), where respective lengths, widths or diameters have been previously determined (**fixed distance counting**). The observer counts the fish within the area laid out. For a given species, the estimate of the mean density  $D$  on a transect of width  $d$  and length  $L$  is expressed as:

$$D = \frac{\sum_{i=1}^p n_i}{Ld} \quad \text{where } n_i: \text{ number of fish seen}$$

In the case of stationary points, density is expressed as:

$$D = \frac{\sum_{i=1}^p n_i}{\pi r^2} \quad \text{where } n_i: \text{ number of fish seen} \\ r: \text{ radius chosen for observation.}$$

<sup>2</sup> The term 'stock' is not used in the fisheries sense but rather as a definition of the quantity (in numbers or weight) of fish that exists in a given environment.



Correctly estimating densities by this method assumes:

- ▶ the observer does not overlook any fish in the set surface area, an unattainable but desirable goal; and
- ▶ individuals are counted only once (see Section II.3).

This method should especially be used for counting populations of fairly sedentary fish (where there is a low risk of error due to rapid individual movement). This method tends to bring about an under-assessment of density and biomass. The width selected for a transect also has an effect on results. The wider the transect, the lower the density estimate, which is logical given that the farther away fish are, the less chance they have of being observed. This relationship varies according to species and groups of species, and is fairly significant for large individuals and more mobile species.

Counting can also be conducted by taking into account the fish's distance from the transect or stationary point at the time of observation (**variable distance counting**). In this case, surface areas are calculated

afterwards. The observer assesses and records the perpendicular distance of fish as viewed from the transect or stationary point. In the case of schools of fish, two distances are taken into consideration: the distance from the transect (or stationary point) to the fish closest to it; and the distance from transect (or stationary point) to the fish farthest away from it.

As with the first method, correct estimation of density is based on certain assumptions.

1. Fish are not counted twice;
2. The fish's distance is determined at the position where it was first observed;
3. The probability of detecting fish within the transect is equal to 1, which means it is presumed that all individuals along the tape measure have been seen and counted.

This method provides good coverage for less mobile species and also limits errors due to rapid movements or fish fleeing when encountered during fixed-distance counts (see Section II.3.2). For this reason, it is better adapted to resource assessment.



## BASIC CONCEPTS OF THE SAMPLING-BY-DISTANCE THEORY

Counting individuals while estimating their distance from the transect or stationary point is based on the fact that not all detectable fish are necessarily seen. It is founded on the theory that detectability — the probability of detecting a fish — decreases with observation distance. In other words, the farther away from the transect or stationary point an individual is, the lower the chances are that it will be observed. Calculating densities depends on the detectability function  $g(x)$ . From these observations, it is possible to extrapolate for a given species, family or population, a curve showing the probability of sighting the fish based on its distance from the transect. Estimated density  $D$  is expressed as follows:

$$D = \frac{\sum_{i=1}^p n_i}{La} \quad \text{where } a = \int_0^{d_{max}} g(x) dx$$

$n_i$  : number of fish

$L$ : length of transect

$d_{max}$ : perpendicular distance from the transect to the limit of detectability

*c* – Assessing individual size

Size assessment allows estimation of:

- ▶ mean sizes;
- ▶ mean weights (from existing size–weight ratios);
- ▶ biomass, which is fresh weight per surface area unit (e.g. g/m<sup>2</sup> or kg/ha); this is calculated using the individual mean weights and abundances;

▶ stock present in the environment: total weight for a given sampled area.

As with abundance and density, mean fish sizes and biomasses are parameters that are affected by fishing activities, particularly with regards to the most heavily targeted species. For example, in the specific case of untouched, or unexploited stock,



the introduction of fishing activities will rapidly lead to a decrease in mean size and biomass for the largest and most long-lived species.















### **II.2.2 – Environmental factors**



Depending on the research question and the resources available to observers, one or more environmental factors can be recorded. The morphology of the study area has an effect on the population's organisation, so it is particularly important to determine the relationships between habitats (substrate, covering organisms, etc.) and the parameters that describe the resource (species richness, density, biomass).

Environmental factors can be divided into two categories: constant factors and variable factors.



- a – Constant factors (or those that vary only slightly)*
-  Location of the site (geographic coordinates + name of site and possibly landmarks)
  -  Type of environment or biotope (barrier, intermediate or fringing reef)
  -  Reef section (slope, forereef, etc.)
  -  Prevailing wind direction
  -  Depth (min. and max.)
  -  Substrate
  -  Type of activity (e.g. regulated or unregulated fishing area, reserve, eco-tourism site)
- b – Variable factors*
-  Date and time (beginning and end)
  -  Visibility
  -  Current
  -  Salinity
  -  Water temperature
  -  Substrate-covering organisms
  -  Associated organisms (invertebrates)



## SUMMARY TABLE

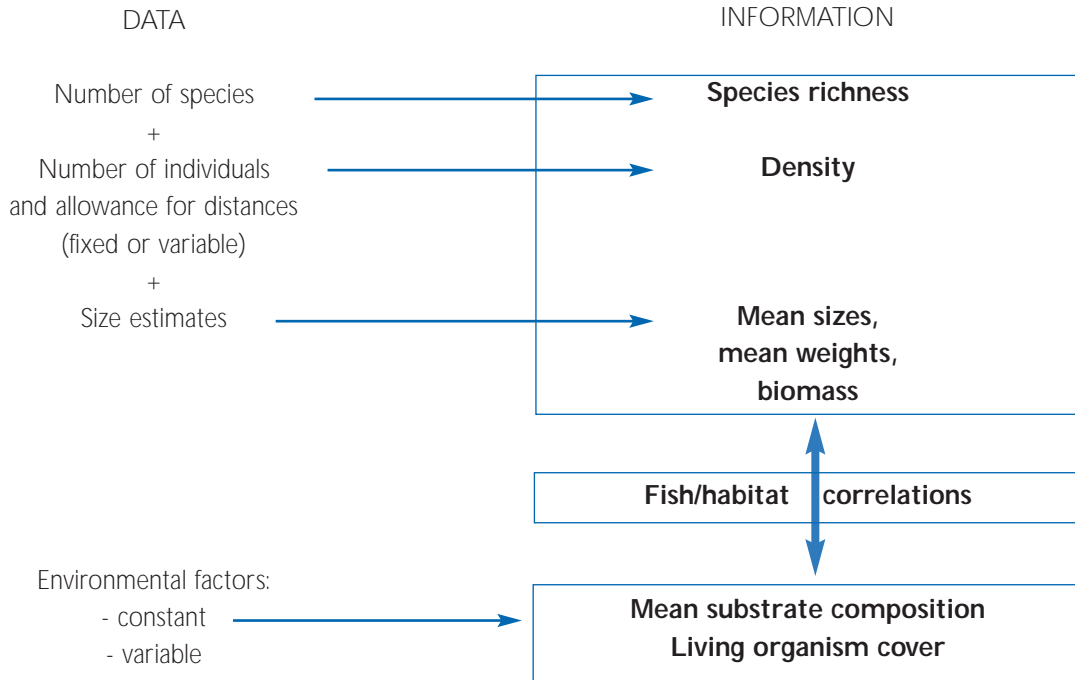

### II.3 – Sources of error

No assessment method is perfect and underwater visual censuses also include sources of error. Errors mainly come from one of three sources: the observer, fish behaviour, and the sampling method. Understanding these sources of error is vital for both

minimising them, and taking them into account during analysis and interpretation of the results.

#### II.3.1 – Sources of error due to the diver

These can be linked to the observer, and/or to interactions between observers and fish. The methods used can also be a source of error.



*a – Errors caused by the observer*

Due to diving time limits and the often shy nature of the animals surveyed, observers must be able to record information as quickly as possible, and rapidly identify and estimate sizes and distances with a reasonable level of accuracy. The slightest hesitation will result in a loss of data. Observers may pay more attention to one group of fish or a part of the population that interests them more, and this also constitutes a systematic error. Observers may also have a tendency to over or underestimate sizes and/or distances. Moreover, there is always a risk of counting the same fish several times. Finally, in the case of variable distance counts, consideration must be given to the fact that fish detectability tends to increase with size for almost all species, and with the size of the school for certain fish (number of individuals in a school).

Hesitation, inattention or paying too much attention to a certain area, are all increased when the conditions under which the census is being conducted worsen (e.g. due to strong currents, fatigue or cold) or when the quantity of information to be recorded is too great (too many species, too many

fish). As a result, environmental, psychological, and physical conditions of observers' work should have as little influence on them as possible. This means that observers should master diving techniques and not be subject to disturbances that reduce the acuity of their eyesight and/or their motor skills.

*b – Observer – fish interaction*

Such interactions mainly involve changes in fish behaviour due to the diver's presence. These changes vary and may result in either the fish fleeing away from, or being attracted to, the diver. For example, some species, such as those from the *Plectropomus* (coral trout) genus, tend to be attracted to observers and follow them around. In contrast, spangled emperors (*Lethrinus nebulosus*) tend to keep away by remaining at the limit of visibility. Such behaviour also depends on the individuals' activity cycle (diurnal vs nocturnal), age and location. The simultaneous trajectories of the fish and observer can bring about either negative or positive biases in size estimation, depending on whether they are swimming in the same direction or in opposite directions



with an angle of vision that differs more than 90° from the transect.

The diver's movement as well as the method used, also has an influence on fish behaviour (e.g. the noise from air bubbles coming out of scuba diving equipment). Regular visits to a site, particularly for monitoring, tend to decrease attraction or fleeing reactions, thus minimising these biases.

### ***II.3.2 – Sources of error due to fish***

The main sources of error due to fish come from the distribution of species in time and space. This depends on different parameters associated with habitat, behaviour and activity cycles.

Certain sedentary species living in rock or coral crevices during the day, coming out only at night, may not be detected by observers. The same is true for those fish that only come out of their hiding places briefly, or those that are highly mobile or which colonise certain biotopes during certain seasons. The probability of encountering species and thus being able to count them, is influenced by their behaviour and their home range or territory. This is why

it is difficult to make a comprehensive assessment of fish populations. It should also be noted that populations seen and sampled only account for a portion of all the species that live in the study area.

The various biological and ecological characteristics of fish influence measurements and estimates. Any interpretation of results must take into account that not all species are perceived (and therefore estimated) in the same way.

### ***II.3.3 – Sources of error due to sampling***

Most sampling errors arise because results depend not only on the elements (all transects or stationary points) that make up the sample (n), but also on the method itself.

A sample is a limited subset of a population, from which the results obtained from the observed data are based. For technical, economic or simply logistical reasons (destruction of specimens, as when fish are caught by experimental fishing), it is normally not possible to collect data on the entire population. Study of a limited set makes it possible to increase both the number of measurements and their degree





of accuracy. Extrapolation of the findings obtained from sampling generally results in estimates for the entire population, which have a reasonable level of accuracy. If two samples composed of a given number of elements (set of transects or stationary points) are observed, the measurements calculated for each will be different, but will result in comparable estimates of population parameters. The statistical population is defined as all the N elements from which conclusions are based (i.e. the N surface area units corresponding to all possible transects in which censuses can be conducted in the selected zone during the

study period). Samples that are not taken according to a strict sampling plan (random or reasoned) will not be representative of the target fish population. The sample is considered to be equal to the statistical population ( $n=N$ ).

A transect's position and orientation can be considered sources of error associated with sampling. It is better to have a transect that covers an homogeneous environment, rather than one covering several different environments. Transitional areas between different biotopes should, therefore, be strictly avoided.

### *IN BRIEF*

**Total error =**

***observation errors (due to the observer)***

**+ *target population coverage errors***  
***(due to observer – fish interactions and to fish)***

**+ *sampling errors***  
***(systematic error + random error)***

## REMEMBER...

The accuracy of population estimates depends on the size of the sample (number of transects) and variability (differences between the measurements for each transect). This variability in individual measurements or random error (dispersion) must not be mistaken for systematic error (bias).

In the figures below, the centre of the target represents the parameter to be estimated and the black dots correspond to measurements made in the transect. Four model situations are given:

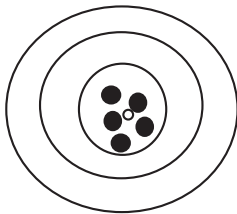

**Low bias  
Low dispersion**

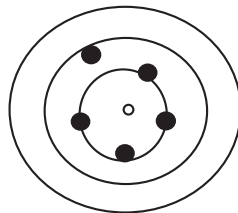

**Low bias  
High dispersion**

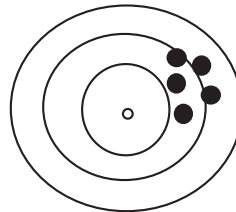

**High bias  
Low dispersion**

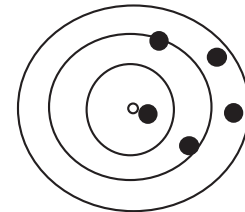

**High bias  
High dispersion**

➤ Lack of accuracy can be linked to high bias and/or high dispersion. The ideal situation is shown in the first picture (low bias, low dispersion).

➤ Sampling-related bias can be reduced by randomly selecting sample elements.

➤ Errors in observation and representativity do not decrease when the size of the sample increases.

➤ Dispersion depends on the population's heterogeneity. It is measured by variance.

➤ When dispersion is high (i.e. there are significant differences between transects), better estimates will be gained by stratifying the population (e.g. by biotope).



## II.4 – How to limit sources of error

### II.4.1 – Observer training







While it is relatively difficult, if not impossible, to minimise errors due to fish, it is easier to limit those due to observers through proper mastery of diving and counting techniques. This comes about through following certain rules during on-site use of the method (see Section III) and by keeping in mind that divers should have regular training to minimise errors caused by poor diving techniques.

#### *a – Identifying fish*

This is the first step of training. Most reef fish of interest for marketing and/or consumption belong to about 15 families, the main ones are listed below.

-  Serranidae (grouper, rockcod, seabass)
-  Carangidae (trevally, jack)
-  Lutjanidae (snapper and seaperch)
-  Caesionidae (fusiliers, bananafish)
-  Lethrinidae (sea bream and emperor)
-  Mullidae (goatfish)
-  Labridae (wrasse)
-  Scaridae (parrotfish)



-  Acanthuridae (surgeonfish)
-  Siganidae (rabbitfish)
-  Kyphosidae (drummer, chub)
-  Holocentridae (squirrelfish)
-  Haemulidae (sweetlips)
-  Chaetodontidae (butterflyfish), act as ecological indicators of coral reef health and can also be added to this list.

The first key to identifying fish is their shape, which is generally the same for almost all the species in a given family (Appendix 1).

The visual morphological characteristics that identify a species within a family are shape, colour of markings, and any distinctive traits such as spots, lines or stripes, and their location on the body and/or fins. Behaviour and preferred biotopes are also useful information for identification. These must all be learned and memorised, which is perhaps the most tedious part of training. The appearance of some fish changes over the life cycle; for example, many wrasse and parrotfish have different colours during their juvenile and adult phases.



In the same way, colours for a single species can differ according to sex. Parrotfish are a good illustration.

Training in fish identification involves classroom-learning using available tools (see 'To Find Out More' section), and on-site exercises during dives. In order to avoid confusion over the use of common names, it is preferable to use each species' scientific name, which is always made up of a genus name (e.g. *Lethrinus*, the genus name for certain breams and emperorfish) followed by a species name (e.g. *nebulosus*; thus forming the name *Lethrinus nebulosus*, or spangled emperor). In practice, it is best to begin learning about 50 species that are easily identifiable. A list of fish, which are of food and commercial interest, is given in Appendix 2. If fish from a certain family cannot be precisely identified during a dive, the observer must be able to rapidly note its main features (e.g. shape, colours, markings) so as to identify it through books afterwards. The use of simple sketches to illustrate and record specific marks on the body is invaluable.

#### *b – Counting individuals*

Difficulties counting fish are mainly due to the limitations of the human eye, which can only count four objects at any one time.

Moreover, precise counting cannot be carried out on more than 10 to 20 individuals in the case of a relatively sedentary school. Taking into account these limits, and in order to compensate for them, the most commonly used technique for counting schools is the so-called group-counting method. This consists of counting a 'group' of 10 to 20 fish. This group becomes the basic counting unit and the observer judges how many groups there are in the entire area occupied by the school of fish. For large schools (> 200 individuals), it may be useful to combine groups into super-groups, containing 5 to 10 base groups.

In more complex instances where a school of fish is made up of several different species (multispecies school), observers are encouraged to begin counting the most abundant (or most numerous) species. The same applies to schools with a range of sizes. During training, taking photographs is a good way to evaluate errors made, and to find out at what level they occurred.



### *c – Estimating individual sizes*

In order to obtain acceptable results, size estimates must reach a certain level of accuracy. The relative difference in sizes must not be more than 20% and should be closer to 10% whenever possible. Numerous factors can affect estimates, including the magnifying effect of water (or mask magnification), the angle the fish is viewed from, water clarity, and the fish's shape.

One of the most commonly used training methods consists of making cut-outs of fish of various shapes and sizes corresponding to the main families to be assessed (see Appendix I). These cut-outs can be easily made using marine plywood or PVC. They are attached to a 150 m weighted line dropped in the water and moored at both ends. The sizes of the cut-outs must cover the entire range of likely fish lengths, from 10 to 100 cm. The diver swims along the line at a preset distance (generally three metres at the beginning of training). He then notes the number, and estimates the size of each cut-out. At the beginning of training, a few reference cut-outs, with the true size indicated, can be used as reference points for estimating the sizes of the others.

Once back on land, the diver's estimates are compared with the real sizes; this comparison allows the diver's performance to be evaluated and shows how much progress has been made. The simplest way is to make a dot graph with the various estimated values recorded on the 'y' axis, and the real sizes of the cut-outs on the 'x' axis. The

### **Visual effects linked to the shape of fish**

These fish are the same in length and yet the bottom one appears longer!

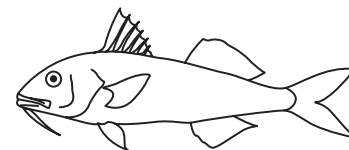
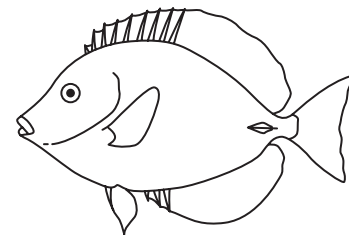



dots should adhere as closely as possible to the straight line where 'x' is equal to 'y', (i.e. where the estimated values correspond to the real values). Dots situated above this straight line show that the observer overestimated the sizes of the cut-outs. On the other hand, when the dots are below the line, the diver has underestimated the sizes. Generally, it is not useful to analyse each separate dot, but rather to note the overall trend in order to see whether the observer has a general tendency to overestimate or underestimate sizes and in which range this occurs. Observers may make preferential errors, such as systematically underestimating the size of larger fish while correctly estimating the sizes of smaller ones.

To go into further detail, performances can be subjected to statistical analysis (t test on the correlation between estimated sizes and real sizes). In order to ensure a correct estimate of fish sizes, training must be repeated until reported sizes are close enough to real sizes (margins of error under 20%). For confirmation, a few fish can be caught during sampling campaigns, measured and their sizes compared with estimates.

### *Calibration line used to measure an observer's ability to estimate sizes.*

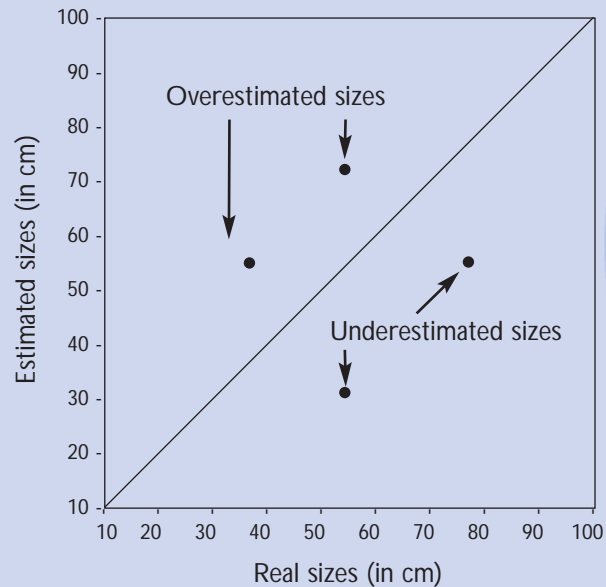

**The results of observations recorded on this graph must come as close as possible to the straight line.**

*d – Estimating distances (in the case of variable distance counts)*

As with sizes, observers must pay careful attention when estimating distances because water has a tendency to magnify objects. Water clarity can also lead to assessment errors. For that reason, when



the water is clear, there is a tendency to underestimate distances, whereas distances are overestimated in turbid waters.

Training in estimating distances perpendicular to the transect can be conducted by laying out two tape measures. These measures serve as reference points at pre-determined distances on either side of the transect, along with objects whose distance from the transect is also known... to everyone but the diver in training. As with fish sizes, results obtained by observers can be compared with the real distances. The exercise can be repeated, taking into account errors (under or overestimation) until the margin of error is reduced.



***The ability to correctly estimate sizes and distances decreases with time; for that reason, training or sampling must be carried out on a regular basis so as to maintain an acceptable level of performance.***

## ***II.4.2 – Basic rules for designing sampling surveys and selecting transects or stationary points***

### ***A. Methodological approach***

It is difficult, if not impossible, to eliminate all the problems associated with sampling. A successful sampling campaign comes from following a methodological approach comprised of specific stages.

#### ***a) Thorough planning***

The planning phase is indispensable for determining justifiable choices. Proper planning allows bias to be minimised, increases the study's accuracy, and avoids problems associated with sampling, which are too often only noted once data have already been collected.



***The best way to validate measurements and verify data is to use and interpret them!***

The planning phase must answer the following questions:

- Which exact organisms will be observed in order to respond to the problem? For example, this can



involve counting all the fish or only counting those fish of commercial interest;

**Which approach should be used?**

The approach can be experimental (the cause of the phenomenon to be studied is induced, by closing and opening a fishing area) or descriptive (the phenomenon is described through sampling the study population: this is the case for sampling in areas subject to different fishing intensities);

**What constitutes the basic element on which observations will be made?** In our case, this means either transects or stationary points.

**What is the study population?** This covers all the elements (transects or stationary points) and is defined by four factors: its nature (e.g. transect), specific characteristics (e.g. transect length), location (e.g. southwest lagoon) and the date on which it is observed (e.g. August 2001);

**Which variables should be considered?** These are the element's attributes. Variables can be quantitative (e.g. number of fish in the transect, fish size, density, biomass) or qualitative (fish species).

**Which measurement method should be used?** In our case, this involves the underwater visual census survey method.

**Which type of sampling strategy should be selected?** This can involve a simple random sampling, one which is stratified by biotope, systematic, etc.

**Which parameters are to be estimated?** This can be the mean or total of a quantitative variable (number of fish, density, biomass), or the percentage of a qualitative variable (% of species), etc.

*b) Acquiring high quality data*

This depends on how collection is carried out and on the sampling strategy.

*c) Rational use of the data*

This includes processing and interpretation but also the conclusions/decisions and the result formulation phase.



**Planning for both sampling and data processing must be carried out simultaneously so as to better justify 'why' and 'how' the collection will be made.**



## B. Sample size

**Sample size** refers to the number of transects needed to arrive at a mean assessment representative of the population; this must include at least two elements in order to measure dispersion. But two is not enough; the more heterogeneous the population is, the greater the sample size must be. To estimate a population parameter to within 10% ( $p=0.1$ ) — 5 chances out of 100 of making a mistake in setting the value of this parameter ( $\alpha=5\%$ ) — the theoretical sample size is found by:

- the mean:  $n_0 = t^2 S^2 / P^2$
- a percentage of an infinite population ( $N > 10,000$ ):  $n_0 = P(100-P)t^2 / P^2$
- a finite population ( $N < 10,000$ ):  
 $n = n_0 / (1 + n_0 / N)$

Where  $S^2$ : sample variance (see definition of variance on page 24);

$P$ : percentage of a modality of a qualitative variable (e.g. percentage of females in the 'sex' variable, which comprises two modalities, males and females)

The sample size can also be calculated based on cost. If you take the total study budget ( $C$ ) and the unit cost ( $c$ ) per

observation (each transect), the number of transects can be found by:

$$n = C/c$$

## C. Sampling plan

The **sampling plan** is the strategy for defining the population to be assessed. The sample selection method (choice of elements), formulation of the estimator, and the characteristics of the study population will all be determined by this plan. Bias, cost and accuracy criteria should be considered during the selection of a sampling plan.

**Randomly selecting** sample units ensures that selection of one individual does not influence selection of others. This means that study staff should not be given any latitude in selection. Random selection can be conducted in a number of ways such as by a computerised selection of geographic coordinates, selecting squares in a gridded area, or by simply pointing a pencil at a map... blindfolded!

It is sometimes difficult to define a random sample. Non-random sampling can give useful results, providing the selection of

## DEFINING VARIANCE

Variance is a measurement of dispersion in the study population. In the theoretical example below, the measurements of a sample's (n) elements are considered to be weights laid out on a horizontal bar, with each weight associated with an individual value.

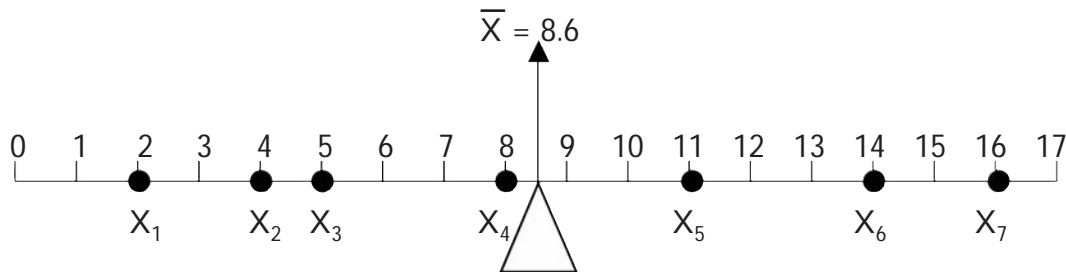

The mean ( $\bar{X}$ ) corresponds to a point at which it becomes possible to balance negative and positive differences:

$$\bar{X} = \frac{X_1 + X_2 + X_3 + X_4 + X_5 + X_6 + X_7}{n}$$

By replacing each measurement with its numerical value, the formula becomes:

$$\bar{X} = \frac{2 + 4 + 5 + 8 + 11 + 14 + 16}{7} = 8.6$$

Variance ( $S^2$ ) is equal to the mean of the square of the sum of the differences between the measurement ( $X_i$ ) and the mean ( $\bar{X}$ ):

$$S^2 = \frac{\sum_i^n (X_i - \bar{X})^2}{n}$$

Using the values in the example, we get:

$$S^2 = \frac{(2 - 8.6)^2 + (4 - 8.6)^2 + \dots + (16 - 8.6)^2}{7} = 24$$



elements can be controlled (reasoned choice) and by carefully avoiding any hasty generalisations. It often represents the most economical method for exploratory studies.

A difference must be made between a **probability sample survey** — where each individual of the population has a previously known probability of belonging to the sample (scientifically thorough with a mathematical theory to support it) — and an **empirical sampling survey**, which does not allow calculation of the probability of individual inclusion (quotas, standard units). The latter survey is less thorough but its use is often dictated by budgetary considerations.

The main probability sample survey plans are:

- **Simple random sampling:** where all elements of the population have the same probability of belonging to the sample.
- **Stratified sampling:** consists of dividing the population into more homogeneous sub-groups. In each stratum, a random sampling is taken. In order to benefit from stratification, a strong correlation must exist between the

stratification factor or factors and the characteristic studied. This means that the structure of the population must already be known and understood.

• **Cluster sampling** (in varying degrees): involves carrying out a random sampling composed of units which are themselves sub-groups of the population (or clusters). The combined units within each sub-group are always representative of the population.

• **Systematic sampling:** consists of systematically sampling an 'n' number of elements separated by a constant interval (interval of time, space, number of lines, etc.). The first element must be chosen on a random basis. This type of sampling is frequently used in underwater visual census resource assessments.

The estimates presented below involve simple random sampling plans. They can be extrapolated from systematic sampling (on the condition that the first element, say a transect, is chosen at random). This can be applied at different scales and allows comparisons in space (e.g. between biotopes) and/or time (e.g. between two dates).



## ***IN BRIEF ...***

*A sampling strategy comprises several aspects:*

- 1) Selecting the population to which the study's conclusions will be applied (particularly with regards to space and/or time limits).*
- 2) Selecting the sample size, which is determined by cost constraints and the level of accuracy desired.*
- 3) Selecting the (n) elements of the sample (sample design).*
- 4) Determining how information about the sample will be gathered (sampling technique = underwater visual census survey).*





## III – SETTING UP VARIABLE DISTANCE UNDERWATER VISUAL FISH CENSUS SURVEYS

The methods presented in this section are based on the distance sampling theory. For that reason, they take into account the fish's distance from the transect or stationary point.

### ***III.1 – Review of safety rules for diving work***

Diving is an activity involving a certain number of risks that can be minimised by following some basic rules, reviewed below.

**Before each dive,** make certain:

- 1) your diving medical fitness certificate is still valid (to be renewed annually);
- 2) you get an up-to-date weather report, if possible;
- 3) your equipment is in good condition and operates properly, particularly your buoyancy vest, tank and regulator;

- 4) proper surface security measures and safety conditions are followed on the boat;
- 5) vital safety equipment functions properly (e.g. VHF radio, emergency oxygen supply, first aid kit, list of medical staff and services to be contacted in the case of an emergency).



***You must be in good physical and mental condition before each dive.***

***Do not dive if you have a cold, are tired, have recently eaten a heavy meal, or have consumed alcohol within the last 12 hours.***

**During the dive:**

- 1) **NEVER DIVE ALONE** (there should always be a minimum of 2 divers)
- 2) Keep visual contact with your dive partner(s) at all times and, if possible, do not move away from them.



- 
- 3) If you lose your dive partner(s), stay for a minute where you are and turn around in a circle (360°); then, slowly ascend looking for the other diver's air bubbles. Near the surface turn completely around (360°). As soon as you arrive at the surface, inflate your vest and make an OK sign to the dive master. **NEVER GO BACK DOWN ALONE.** Wait for the others.
  - 4) Avoid going up and down ('yoyo' movement).
  - 5) For dives whose maximum depth is greater than 10 m, systematically make a three-minute safety pause at three metres before coming to the surface.
  - 6) In general, try to stay under the time limit beyond which decompression is necessary.
  - 7) Always ascend slowly (do not go faster than the speed of the small air bubbles).

#### **After the dive:**

- 1) Record your diving parameters (sites, maximum depths reached, total time, length of pauses, specific facts).
  - 2) Carefully rinse your equipment with fresh water and check its condition.
  - 3) Avoid any strenuous physical effort or free diving for eight hours following your final dive.
  - 4) Do not take a plane within 24 hours after your final dive.
- 



*It is worth noting that in almost all recorded diving accidents over the past few years, one or more of these rules was not followed. Following them would have undoubtedly helped save many lives. Never forget that all divers are responsible for both their own safety and that of their fellow divers.*

### **III.2 – Equipment**

#### **On the boat be sure there are:**

- ID books (see 'To Find Out More...' section)
- different coloured pocket folders (1 for the blank record sheets, 1 for completed sheets)
- 1 portable GPS + spare batteries
- erasers
- pencil sharpener

#### **HINT**

*In order to keep books dry and ensure that they do not get damaged, keep them covered with plastic, and keep water- and moisture-sensitive materials in a waterproof container (such as a cooler or eski).*

#### **For working underwater, you should have:**

- 3 fifty-metre measuring tapes
- 1 hard plastic board with clips (at least two) per diver
- record sheets (at least 3 station sheets and 5 fish record sheets)
- pencils (at least 2 per diver: 1 in the sleeve of the diving suit or knife)



*Fifty-metre measuring tape*

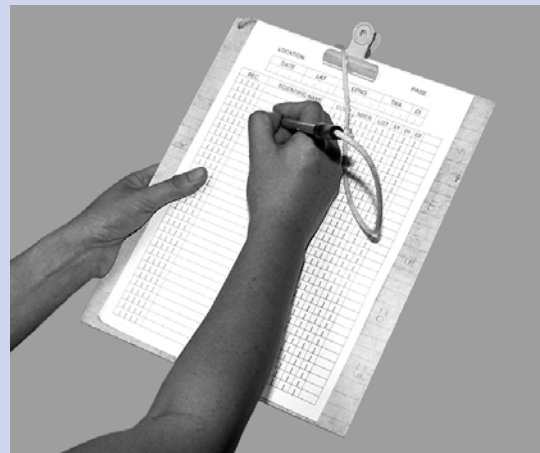

*Hard plastic clip board*



sheath + 1 attached by string to the board)

 waterproof watch

 depth gauge

### ***HINT***

*It is better to use wood-free synthetic resin pencils, as these have the advantage of not splitting and having stonger lead.*

## **III.3 – Transects**

The method presented below uses standard 50-metre-long transects.

### **On the boat before the dive:**

 fill in the top part of the station sheet with general information about the station (e.g. station number, GPS position, brief description, etc) (see Appendix 4). Do the same thing on the fish data record sheet (see Appendix 3).

### **During the dive:**

 Before descending, make a final check with your buddy to ensure nothing has been forgotten (double verification).

 Descend.

 Once you arrive at the bottom, determine the starting point for the transect.

 Attach one end of the measuring tape to a rock, or in the sand, using a metal stake and lay the other two measuring tapes next to it.

 Determine the direction for laying out the measuring tape.

 Wait two or three minutes to give the fish time to calm down and get use to your presence.

 Begin counting the fish.

 One of the divers unrolls the measuring tape as the count progresses.



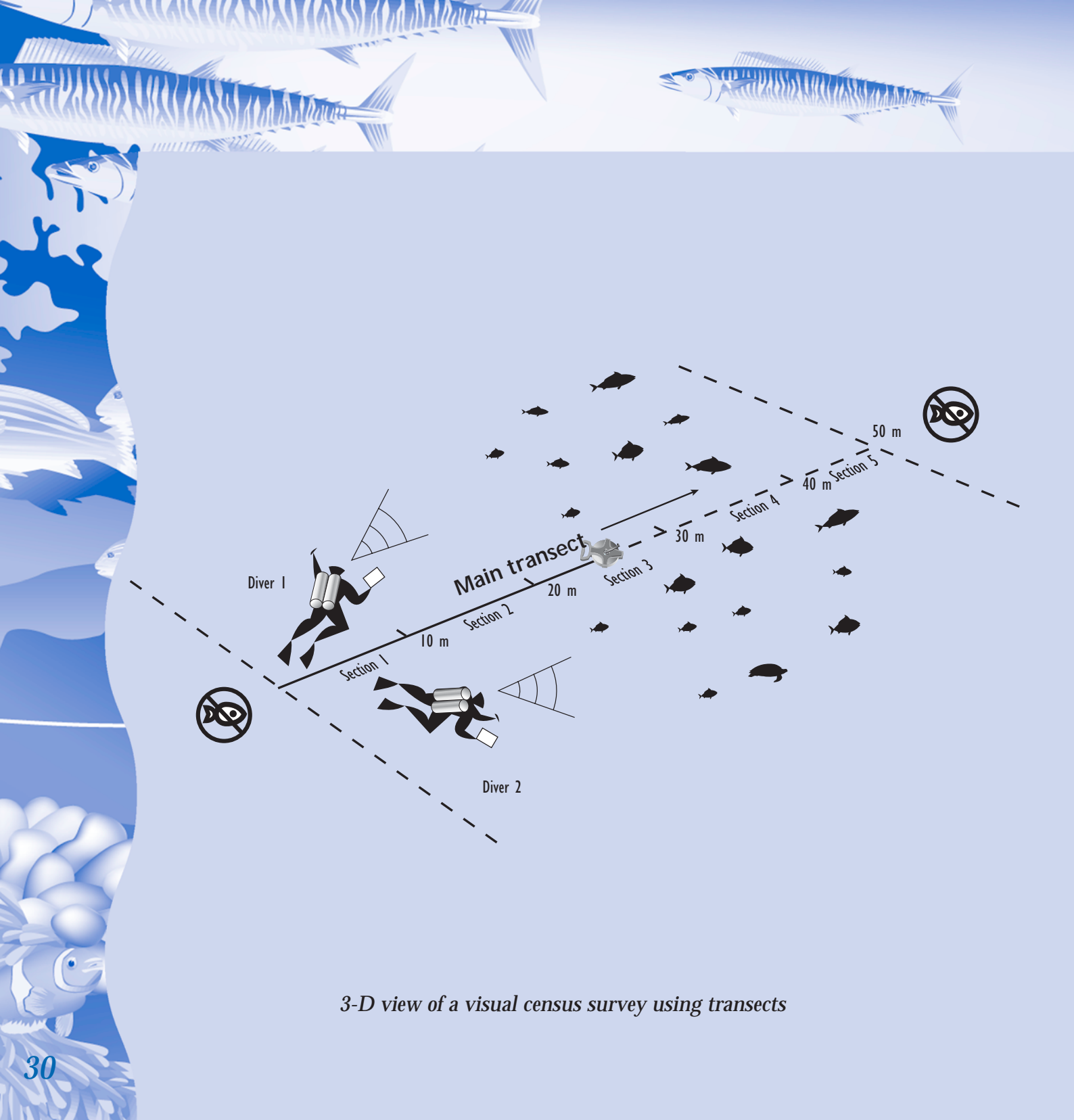

*3-D view of a visual census survey using transects*



## ***RULES TO FOLLOW DURING THE COUNT***

- 1) *It is best to work in sections of about three metres each as this helps avoid counting the same fish more than once.*
  - 2) *In cases where each diver counts on one side of the transect, care must be taken to ensure divers proceed at the same rate. If only one diver is conducting the count, he must first count on one side and then on the other. The tape is then unrolled by the other diver, who stands by while the observer continues to work.*
  - 3) *Do not stay in any one spot too long and do not count fish who enter your field of vision too long a time after you have stopped. If they must be counted, then situate them at the outer limit of visibility.*
  - 4) *If possible, begin by counting the most abundant species.*
  - 5) *Given the theories related to variable distance censuses (see Section II.2.1), systematically give greater importance to fish that are near the transects. In practical terms, it is important at each stop to begin counting in the immediate vicinity of the transect and then pay attention to species farther away (i.e. carry out observations from the transect towards the limit of visibility).*
  - 6) *Always fill out the dive sheet in the same way. Mark the name of the fish (see remark below), then the number, size and finally the perpendicular distances to the transect.*
  - 7) *Scientific names are sometimes long and tedious to write underwater, so don't hesitate to use abbreviations when these are easily understandable and can be immediately recalled afterwards. For example, you might write Acant xant for Acanthurus xanthopterus, or Sc riv for Scarus rivulatus.*
- 



- 1) *Stay close to the measuring tape and do not move away from it in order to avoid distorting estimates of the perpendicular distances of fish from the transect.*
- 2) *Don't forget that the transect is 50 metres long. Care must be taken to not go over one end or the other. Imagine perpendicular lines on the transect at 0 and 50 metres, which constitute the count boundaries. When two divers conduct the count, both must count within the boundaries set out by the transect (i.e. the 50 m tape measure). If in doubt about whether a fish has already been counted by your team mate, ask.*

- Once the fish count is done, leave the main transect in place and unroll the other two tape measures about three metres on either side of the main transect<sup>3</sup>.
- Record the visibility, current and other known parameters for this station in the top part of the station sheet (see Appendix 4).

## **HOW TO ESTIMATE VISIBILITY?**



*A simple method consists of placing a clipboard vertically at some point along the main transect. On your way back to wind up the tape or record the substrate, note the distance on the tape when the clipboard first becomes visible to you.*

- For each of the three transects and in every 10-metre section, identify once every metre the nature of the substrate and the living organism cover just below the measuring tape. Record your observations on the station sheet by putting check marks in the corresponding headings (see Appendix 3)
- In the one-metre strips on either side of each transect, count the number of associated organisms (invertebrates).
- On the back of the station sheet, record any special remarks about that station.

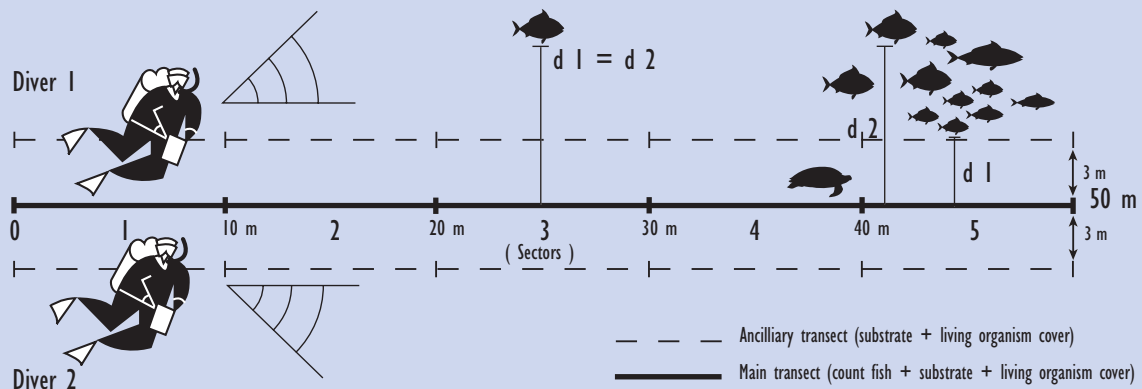
<sup>3</sup> In the case of fixed distance counting, the three tape measures can be laid out three metres apart at the beginning of the dive.





*2-D view of a visual census survey using transects*



-  Make sure the sheets have been filled out fully and accurately.
-  Roll up the three tape measures.
-  Begin your ascent (see recommendations for diving work).

### After the dive:

#### *On the boat:*

-  Proceed with initial discussions immediately, then complete and correct the sheets, if necessary.
-  Take the sheets off the clipboards and put them into the corresponding plastic pocket folders.

#### *On land:*

-  Rinse the sheets one by one in fresh water, then place them separately to dry.
-  Once they are dry, take the sheets and finish or correct them, as needed.
-  Begin data entry.

### **III.4 – Stationary points**

The steps to follow before getting into the water are exactly the same as those mentioned for transect counting. This also applies to the after-diving rules and the



important points to follow during the dive. The specific characteristics associated with stationary point counts are as follows:

- While treading water, visually determine the observation point.
- Without standing on the bottom, come upright in the water and count the number of fish within the central circle (i.e. in a one-metre radius around the observation point).
- Once you are done counting within the central circle, stand on the sea floor at the observation point and identify a reference radial so as to continue the census.
- Continue counting from this reference point while slowly turning in a complete circle (360°). Follow the same rules as for transects.
- Once the fish count is done, unroll a 10-m tape measure, centring it on the observation point. Then unroll the other two 10-m tape measures two metres apart on either side of it.
- In each of the three transects laid out in this way, identify once every metre the type of substrate and the living organism cover below the tape.

Record the results of your observations on the station sheet by putting check marks in the corresponding sections (see Appendix 4)<sup>4</sup>.

- Once identification is done, move the outer two tape measures 2 metres farther on, repeating the same operation for the two new transects.
- In each of the transects you have now laid out, count the number of associated organisms (invertebrates) found within a one-metre strip on either side of the tape measures.

<sup>4</sup> Each transect corresponds to a different section on the data entry sheet.



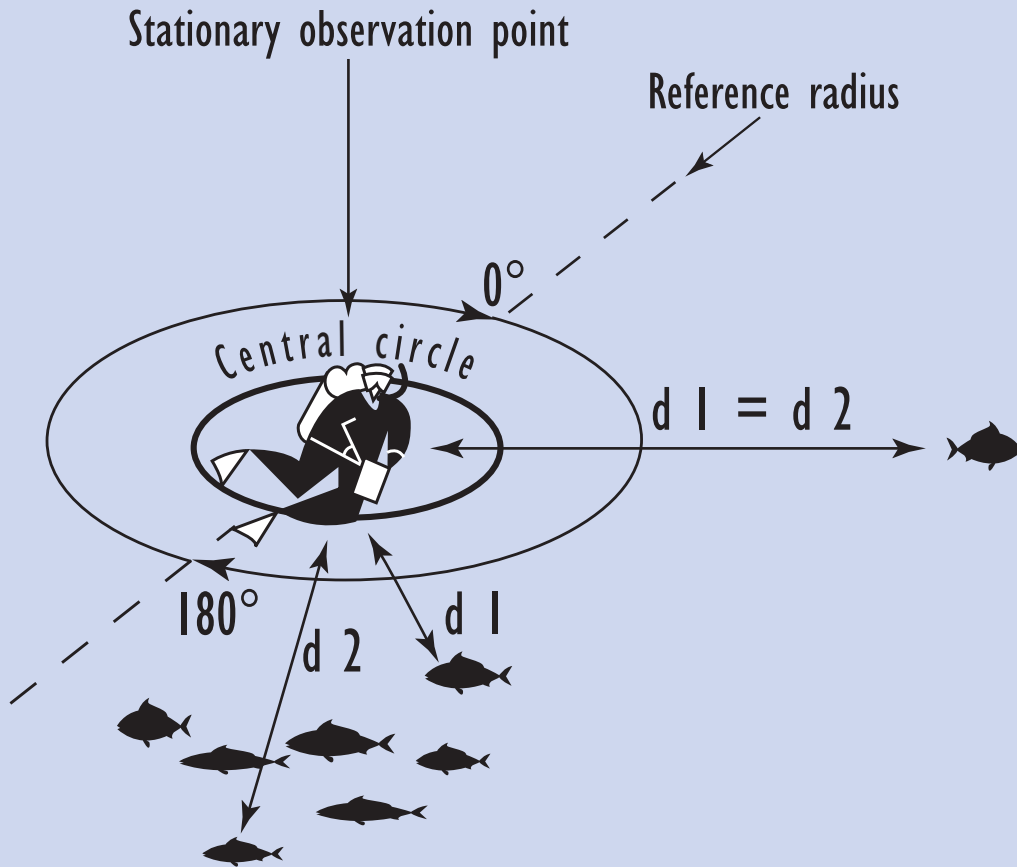

*3-D view of a visual census survey using stationary points*

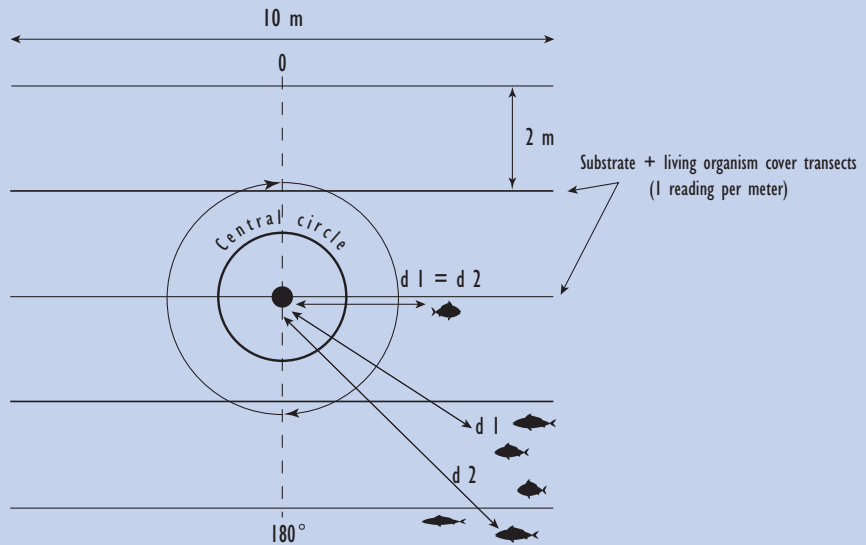

*Vertical view of a stationary point visual census survey*

### ***WORK DOUBLES AS TRAINING...***

*You should seize every possible opportunity to calibrate your measurements and improve your size and distance estimation skills.*

- 1) When a fish is stationary on the sea floor, note the land marks corresponding to the ends of its head and tail, then measure how far apart they are with the ruled edge of your clipboard.*
- 2) When moving down the transect, make it a habit to estimate the distance to the next stopping point and then compare this estimate to the real distance as shown by the tape measure.*
- 3) When you move away from the transect to identify a species, try to measure the distance separating the fish from the transect by using as a reference, say, the length of your own body. In this case, be careful not to record any fish that were not observed from the transect.*



## IV – USING THE DATA COLLECTED

### ***IV.1 – Entering and formatting data***

Special attention must be paid to data entry, coding and formatting of data. The results of the assessment will depend on how well this work is done.

The main purpose of data entry is to allow rapid computer processing of data. The risks inherent in this operation arise mainly from the additional source of error it represents. In those cases where data are entered directly into a spreadsheet programme, double entry is strongly advised, if possible by two different operators. The two sheets can then be compared for verification purposes, thereby making it possible to limit the sources of error associated with transferring data into the computer.

#### ***HINT***

***In order to facilitate data entry, it is better to have each entry line correspond to an observation and to make a column for each parameter in the order in which they appear on the site record sheet whenever possible (see Appendix 3).***

### ***IV.2 – Calculating densities, biomass and stock (numeric and weighted)***

For variable distance transects or stationary points, the density and biomass estimates presented below are based on the calculation of a mean weighted distance (dm) of the individuals in the transect or at the stationary point. For most species, this produces results that are comparable to other methods that require adjusting a mathematical function to the fish detectability curve in order to estimate the parameter (a) (see Section II.2.1). This calculation method also has the advantage of being simple.

In order to do this, either side of the transect is divided into one-metre-wide corridors, the closest at 0 to 1 metres, the second at 1 to 2 metres, etc. Depending on the fish's distance at the time of observation, it will then be associated with one of these corridors and given its median value (i.e. the middle of that category). For example, if an individual is recorded at a perpendicular distance of 2 metres from the transect, it will be considered to have

been seen in the 2 to 3 metre corridor. The distance value used in the calculation will be  $2 + 0.5 = 2.5$  metres, which corresponds to the median of the 2 to 3 metre category.

For that reason, the **mean weighted distance** of a species is given by:

$$dm_j = \frac{\sum_{i=1}^p n_{ij} (d_{ij} + 0.5)}{\sum n_{ij}} \quad (1)$$

where  $p$ : total number of observations (occurrences) of species  $j$  (one observation can comprise several individuals)

$n_{ij}$ : number of fish in observation (occurrence)  $i$  (generally  $i = 1$ , but it can take on a higher value in the event of schools)

$d_{ij}$ : perpendicular distance of fish  $i$  from the transect. In the case of schools, it becomes:

$$d_{ij} = \frac{(d1+d2)}{2}$$

The **estimated density** can then be obtained by:

$$D_j = \frac{\sum_{i=1}^p n_{ij}}{dm_j L} \quad (2)$$



The **biomass estimate** is obtained through the use of length-weight ratios:

$$B_i = \frac{\sum_{i=1}^p n_{ij} \cdot W_{ij}}{dm_j L} \quad (3)$$

where  $W_i$ : estimated weight of fish  $i$  using length-weight ratios



*Calculations can be made for each separate species, or all the fish from a single family, or the study population using data from one or more transects. The best overall estimates are obtained by considering all the species taken as a whole and not by calculating the sum of the per species estimates. Differences between these two types of estimates can be fairly large, especially when the number of species is high.*

The **stock estimate** ( $Q$ ) is made by multiplying the biomass  $B$  by the stock distribution surface area:

$$Q_j = B_j \cdot A \quad (4)$$

where  $A$ : surface area of the biotope or zone where the biomass  $B$  estimate was made.



Number	Length (in cm)	Distance 1 (in m)	Distance 2 (in m)
1	8	4	4
2	10	1	2
2	22	2	2
7	12	2	4
2	18	4	6
3	22	4	4
4	18	3	4
3	15	5	6
2	20	3	4
4	15	3	4
2	22	3	4
4	15	5	6
1	17	4	4
2	15	5	6
6	11	2	4
1	18	4	4
10	15	0	3
1	20	3	3
7	13	6	8

64 = Total number of fish

48 = Total number of fish between 0 - 5 m

### Example of calculating the weighted mean distance, density and biomass:

The selected example comes from the results of observations made during a dive on 28 November 1998 at Station #4 in the Namoui Marine Reserve on Niue. A total of 64 individuals of *Ctenochaetus*

*striatus* were recorded on both sides of the transect: (see table opposite)

By applying Equation (1), the weighted distance is equal to:

$$dm_j = \frac{1(4+0,5) + 2(0,5+1,5) + \dots + 7(7+0,5)}{64} = 4,23 \text{ m}$$

The mean density estimate for this transect can, then, be obtained by using Equation (2) which produces:

$$D = \frac{64}{2 \times 4,23 \times 50} = 0,151 \text{ individuals/m}^2$$

Note: If the same operation had been carried out using a transect with a fixed five-metre width, density would have been equal to:

$$D = \frac{48}{2 \times 5 \times 50} = 0,096 \text{ individuals/m}^2$$

This value is underestimated compared with that obtained by variable distance counting.

For this species, using the length – weight ratio  $W = 0.0254L^{3.027}$  obtained by Letourneur et al. (1999), it is possible to calculate the mean weight for each individual or group of individuals. The result of this calculation is presented in the following table.





Number (n)	Length (in cm)	Individual weight (in g)	Weight (W) (in g)
1	8	14	14
2	10	27	54
2	22	294	588
7	12	47	329
2	18	160	320
3	22	294	882
4	18	160	641
3	15	92	277
2	20	220	441
4	15	92	369
2	22	294	588
4	15	92	369
1	17	135	135
2	15	92	184
6	11	36	216
1	18	160	160
10	15	92	922
1	20	220	220
7	13	60	419
<b>Total weight =</b>			<b>7127</b>

By applying Equation (3), the biomass is equal to:

$$B = \frac{7127}{2 \times 4.23 \times 50} = 16.9 \text{ g/m}^2$$

### IV.3 – Calculating the accuracy of density and biomass estimates

It is difficult to simply estimate the accuracy of a measurement by taking into account all the sources of error while at the same time integrating all the sources of variability into a single clear calculation. It is, however, possible to approach estimate accuracy through an initial descriptive analysis of the samples. In cases such as ours, where the sampling unit is a transect, dispersion (or variance) between transects can be calculated for any given biotope and/or point in time. This makes it possible to calculate the standard deviation for density or biomass measurements and thus establish comparisons for the sample between prospected biotopes or two points in time. This calculation gives an idea of the accuracy of estimates on the scale of the target population.

Inter-transect variance (S<sub>D</sub><sup>2</sup>) for density is found by (see definition of variance on page 24):

$$S_D^2 = \frac{\sum_i^n (D_i - \bar{D})^2}{n} \quad (5)$$

where  $D_i$ : density in transect  $i$   
 $\bar{D}$ : mean density of transects for a given biotope  
 $n$ : number of transects

For the biomass, it equals:

$$S_B^2 = \frac{\sum_i^n (B_i - \bar{B})^2}{n} \quad (6)$$

where  $B_i$ : biomass in transect  $i$   
 $\bar{B}$ : mean density of transects for a given biotope  
 $n$ : number of transects

The square root of the variance (standard deviation) is used so that work can be carried out in the same measuring unit as that used for the mean. Standard deviation for density is obtained by:

$$S_D = \sqrt{S_D^2} \quad (7)$$

For biomass, standard deviation equals:

$$S_B = \sqrt{S_B^2} \quad (8)$$

### Model calculation

During a duty travel in 1998, a census on fish of interest for consumption and marketing was conducted in the Namoui Marine Reserve on Niue. Two biotopes were selected, the sub-intertidal reef flat and the fringing reef slope. A total of 16 transects were made (i.e. eight for each biotope). The esti-

mated density and biomass values for each transect and all observed species combined are given in the following table:

Sub-intertidal reef flat			Fringing reef slope		
Transect no.	Density (ind/m <sup>2</sup> )	Biomass (g/m <sup>2</sup> )	Transect no.	Density (ind/m <sup>2</sup> )	Biomass (g/m <sup>2</sup> )
3	0.194	24.8	1	0.197	41.7
4	0.327	42.7	2	0.257	61.5
5	0.449	53.0	6	0.245	32.6
8	0.782	98.0	7	0.305	67.4
9	0.355	66.1	10	0.389	69.3
12	0.281	52.1	11	0.560	99.9
13	0.315	71.1	14	0.217	29.9
16	0.419	66.5	15	0.455	61.3
Average	0.390	59.3	Average	0.328	57.0

Density variance on the sub-intertidal reef flat was calculated by applying Equation (5). It equalled:

$$S_D^2 = \frac{(0.194-0.390)^2 + (0.327-0.390)^2 + \dots + (0.419-0.390)^2}{8} = 0.027$$

Standard deviation for the density measurement was calculated through variance by applying Equation (7), which gave:

$$S_D = \sqrt{0.027} = 0.165 \text{ individus/m}^2$$



The estimated density for the sample was equal to the mean of the measurements plus or minus standard deviation (i.e.  $0.390 \pm 0.165$  individuals/m<sup>2</sup>).

Biotope	Sub-intertidal reef flat		Fringing reef slope	
Parameter	Density	Biomass	Density	Biomass
Variance	0.027	411.2	0.014	462.0
Standard deviation	0.165	20.3	0.120	21.5

#### **IV.4 – Mean composition of substrate and living organism cover**

A total of 150 features are recorded for transects and 50 features for stationary points. For each category of substrate and living organism cover, the mean composition is expressed as a percentage of the total number of observations. It is obtained by:

$$\overline{CM} = \frac{nr}{NR} \times 100$$

Where: nr: number of readings for each category of substrate or covering organism  
NR: total number of readings



**For the mean substrate composition, the sum of the percentages from all categories must equal 100%.**

#### **IV.5 – Initial analysis of results**

##### **IV.5.1 – Comparing results**

###### *a) Density and biomass*

An initial interpretation of the results can easily be conducted by plotting on a graph the means and standard deviation values for the biomasses and densities obtained from different environments or at different times. In the figure below, the mean biomass values have been calculated for the various reef biotopes that make up the eastern and western lagoons of the Northern Province of New Caledonia. These means are symbolised by dots or triangles and the confidence intervals by bars whose ends indicate the minimum and maximum values on either side of the mean. On small island reefs, the fact that the bars overlap suggests that biomasses are not significantly different. On the other hand, for the other two environments (fringing and barrier reefs), the values obtained on the west coast are significantly higher than those on the east coast. This same graphic exercise can be conducted using the results obtained in the model calculation in Section IV.3. The sample does



not show any differences in density or biomass between the values estimated for either the sub-intertidal reef flat or the fringing reef slope. This type of analysis can allow simple initial comparison of biotopes or sampled areas as well as comparisons between regular time intervals within a single environment (resource monitoring). Differences can be validated statistically at a later time.

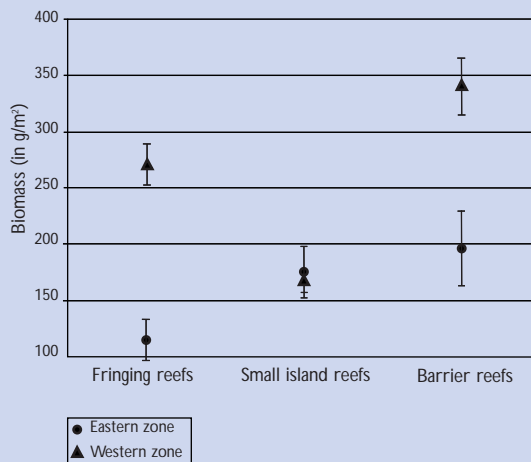

Graphic representation of biomass by reef types studied in the eastern and western lagoons of the Northern Province of New Caledonia. The bars correspond to standard deviations around the mean (dots or triangles)

#### b) Mean composition of the substrate and covering organisms

Initial comparisons can be made by simply converting the values into bar graphs. In the figures below, the values for each component of the substrate and covering organisms were estimated on the slopes and flats of two sections of the fringing reef around the island of Niue (Avatele and the Namoui Marine Reserve). These results were expressed in terms of percentages and then displayed as bar graphs, and show there were no significant differences in the mean composition of the substrate and the living organism cover between the sites and biotopes. The substrate was composed mainly of hard bottom with a high predominance of rock (more than 80%). Living organism cover was about 50% of the total surface area, mainly in the form of small branching corals. Coral heads, encrusting corals and large branching corals accounted for lower percentages.



Namoui Marine Reserve

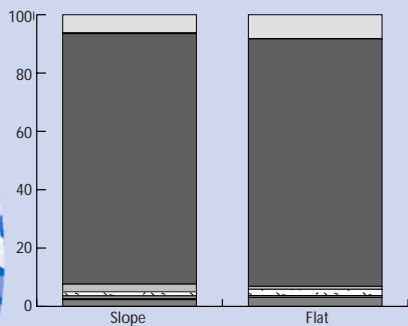

Avatele (outside reserve)

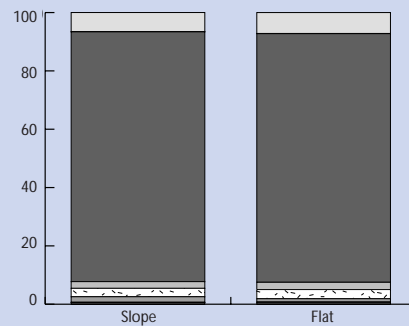

Graph of the mean substrate's composition on two sites of the island of Niue

Namoui Marine Reserve

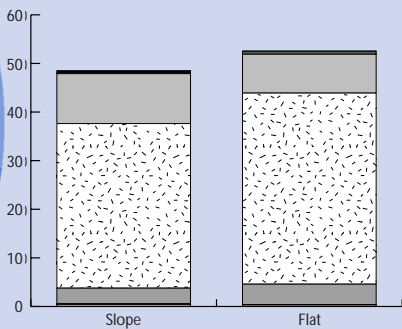

Avatele (outside reserve)

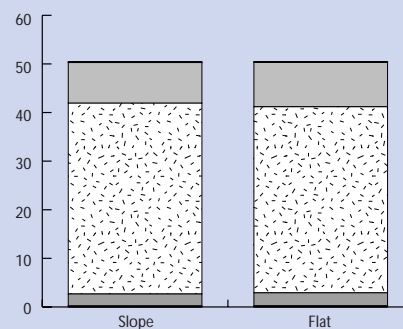

Graph of the living organism cover (in %) at two sites of the island of Niue



#### ***IV.5.2 – Correlations between fish and environmental factors***

Analysing correlations between fish and environmental factors makes it possible to determine possible links between the parameters of the population or section of the population (mean species richness, density or biomass) and certain basic elements of the habitat and environment (substrate or living organism cover components).

An initial empirical approach can be developed very simply. This consists of analysing on a graph the dispersion of dots denoting estimated values of selected population parameters (e.g. mean species richness, density or biomass) for a group of stations (each dot represents the results from one station) on the 'y' ordinate in relation to the percentage of a component of the substrate or a category of covering organisms on the 'x' axis. Two cases are possible. In the first instance, the scatterplot is dispersed and does not reveal any kind of correlation. In the second instance, the dots seem to be non-randomly distributed and it is possible to make a curve with

most of them, thereby revealing a trend. This initial analysis can be strengthened by analysing the correlation between parameters taken in pairs and then trying to arrive at a curve which passes through a maximum number of dots (e.g. by carrying out a regression through the least-squares method). A correlation coefficient can then be calculated and tested statistically.



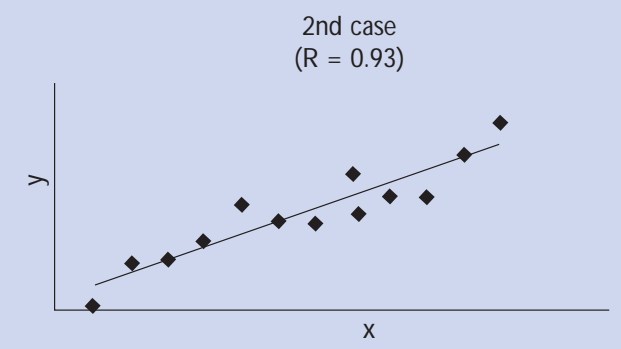
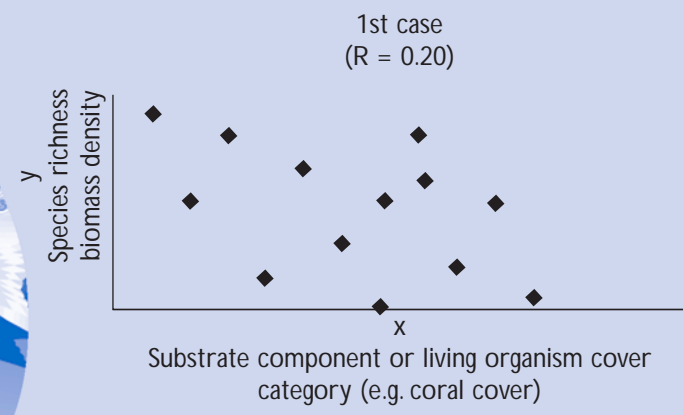

Theoretical representations of estimated fish population parameters by the nature of the substrate and covering organisms. First case: dispersed scatterplot, no trend; second case: the scatterplot shows a trend demonstrated by the straight line.

( $R$  = correlation coefficient)



## V - CONCLUSIONS

The use of variable distance underwater visual census survey methods can provide appropriate responses to questions raised during the assessment of reef and lagoon fish resources.

However, implementing these methods involves paying attention to certain rules and precautions in order to obtain usable and, therefore, acceptable results. These rules can seem too numerous or too complicated, but this is not the case at all. They can be learned easily and gradually.

Thereafter, training and regular practice are the only way of guaranteeing that the skills are acquired and maintained. Any skill will become rusty if it is not practiced on a regular basis.

As for data processing, a large range of possible statistical processing and analysis techniques exists. Depending on the information sought and the questions raised by the assessment, it is always possible to refer to specialised works in order to begin using them. But if this should not

prove possible, do not hesitate to request the advice of specialists, who can always process the data if they are of adequate quality.









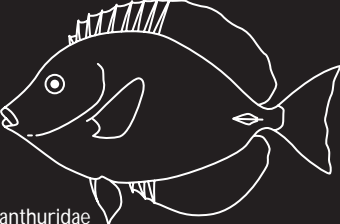

### ***IN SUMMARY...***

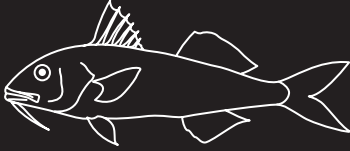
***Always remember that information collection and processing are two sides of the same coin and are, therefore, interdependent.***



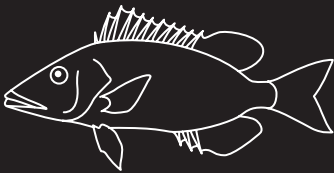

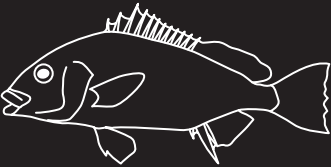
**Appendix 1. Outlines of the major fish families that are of food and/or commercial interest**

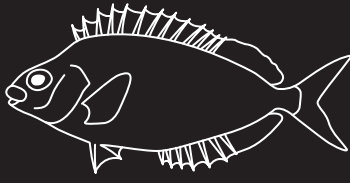
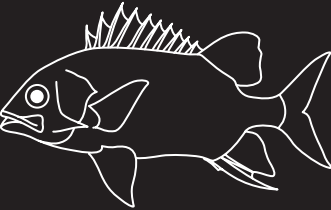
 Acanthuridae	 Kyphosidae	 Mullidae
 Carangidae	 Labridae	 Scaridae
 Caesionidae	 Lethrinidae	 Serranidae
 Haemulidae	 Lutjanidae	 Siganidae
 Holocentridae		

Source: Fishes of the Great Barrier Reef and Coral Sea. Randall et al. 1997

## Appendix 2. List of fish species that are of food and/or commercial interest

### ACANTHURIDAE

*Acanthurus achilles*  
*Acanthurus albipectoralis*  
*Acanthurus blochii*  
*Acanthurus dussumieri*  
*Acanthurus lineatus*  
*Acanthurus mata*  
*Acanthurus nigricans*  
*Acanthurus nigricauda*  
*Acanthurus nigrofuscus*  
*Acanthurus olivaceus*  
*Acanthurus pyroferus*  
*Acanthurus triostegus*  
*Acanthurus xanthopterus*  
*Ctenochaetus binotatus*  
*Ctenochaetus striatus*  
*Naso annulatus*  
*Naso brachycentron*  
*Naso brevirostris*  
*Naso hexacanthus*  
*Naso lituratus*  
*Naso tuberosus*  
*Naso unicornis*  
*Naso vomer*  
*Paracanthurus hepatus*  
*Zebrasoma flavescens*  
*Zebrasoma scopas*  
*Zebrasoma veliferum*

### SERRANIDAE

*Anyperodon leucogrammicus*  
*Cephalopholis argus*  
*Cephalopholis boenack*  
*Cephalopholis miniata*  
*Cephalopholis sexmaculata*  
*Cephalopholis sonnerati*  
*Cephalopholis urodeta*  
*Cromileptes altivelis*  
*Epinephelus areolatus*  
*Epinephelus caeruleopunctatus*  
*Epinephelus coioides*  
*Epinephelus cyanopodus*  
*Epinephelus fasciatus*

*Epinephelus fuscoguttatus*  
*Epinephelus hexagonatus*  
*Epinephelus howlandi*  
*Epinephelus macrospilos*  
*Epinephelus maculatus*  
*Epinephelus malabaricus*  
*Epinephelus merra*  
*Epinephelus ongus*  
*Epinephelus polyphekadion*  
*Epinephelus rivulatus*  
*Epinephelus suillus*  
*Epinephelus tauvina*  
*Plectropomus laevis*  
*Plectropomus leopardus*  
*Plectropomus maculatus*  
*Variola louti*

### SCARIDAE

*Bolbometopon muricatum*  
*Cetoscarus bicolor*  
*Chlorurus bleekeri*  
*Chlorurus sordidus*  
*Hipposcarus longiceps*  
*Scarus altipinnis*  
*Scarus chameleon*  
*Scarus flavipectoralis*  
*Scarus forsteni*  
*Scarus frenatus*  
*Scarus ghobban*  
*Scarus globiceps*  
*Scarus longipinnis*  
*Scarus microrhinos*  
*Scarus niger*  
*Scarus oviceps*  
*Scarus psittacus*  
*Scarus quoyi*  
*Scarus rivulatus*  
*Scarus rubroviolaceus*  
*Scarus schlegeli*  
*Scarus spinus*

### LETHRINIDAE

*Gnathodentex aureolineatus*  
*Gymnocranius euanus*  
*Gymnocranius grandoculis*  
*Lethrinus atkinsoni*  
*Lethrinus erythracanthus*  
*Lethrinus genivittatus*  
*Lethrinus harak*  
*Lethrinus kallopterus*  
*Lethrinus lentjan*  
*Lethrinus nebulosus*  
*Lethrinus obsoletus*  
*Lethrinus olivaceus*  
*Lethrinus rubrioperculatus*  
*Lethrinus variegatus*  
*Lethrinus xanthochilus*  
*Monotaxis grandoculis*

### LUTJANIDAE

*Aprion virescens*  
*Lutjanus adetii*  
*Lutjanus argentimaculatus*  
*Lutjanus bohar*  
*Lutjanus fulviflamma*  
*Lutjanus fulvus*  
*Lutjanus gibbus*  
*Lutjanus kasmira*  
*Lutjanus lutjanus*  
*Lutjanus monostigma*  
*Lutjanus quinquelineatus*  
*Lutjanus rivulatus*  
*Lutjanus russelli*  
*Lutjanus sebae*  
*Lutjanus vitta*  
*Macolor macularis*  
*Macolor niger*  
*Pristipomoides multidentis*  
*Symphorus nematophorus*

### MULLIDAE

*Mulloides flavolineatus*  
*Mulloides vanicolensis*  
*Parupeneus barberinoides*

*Parupeneus barberinus*  
*Parupeneus bifasciatus*  
*Parupeneus ciliatus*  
*Parupeneus cyclostomus*  
*Parupeneus dispilurus*  
*Parupeneus heptacanthus*  
*Parupeneus indicus*  
*Parupeneus multifasciatus*  
*Parupeneus pleurospilos*  
*Parupeneus pleurostigma*  
*Parupeneus spilurus*  
*Upeneus tragula*  
*Upeneus vittatus*

### SIGANIDAE

*Siganus argenteus*  
*Siganus corallinus*  
*Siganus doliatus*  
*Siganus fuscescens*  
*Siganus lineatus*  
*Siganus oramin*  
*Siganus puellus*  
*Siganus punctatus*  
*Siganus spinus*  
*Siganus vulpinus*

### HAEMULIDAE

*Diagramma pictum*  
*Plectorhinchus chaetodonoides*  
*Plectorhinchus diagrammus*  
*Plectorhinchus gibbosus*  
*Plectorhinchus goldmanni*  
*Plectorhinchus obscurum*  
*Plectorhinchus orientalis*  
*Plectorhinchus picus*  
*Pomadasyrg argenteus*

### CAESIONIDAE

*Caesio caeruleaura*  
*Caesio cuning*  
*Pterocaesio trilineata*  
*Pterocaesio tile*





## Appendix 4. Environmental factors record sheet

Site no.: \_\_\_\_\_ Site name: \_\_\_\_\_ Visibility (m): \_\_\_\_\_  
 Latitude (deg/min/sec): \_\_\_\_\_ Longitude (deg/min/sec): \_\_\_\_\_  
 Date (day/month/year): \_\_\_\_\_ Current (none: 0, weak: 1, strong: 2): \_\_\_\_\_  
 Fringing reef: \_\_\_\_\_ Middle reef: \_\_\_\_\_ Barrier reef: \_\_\_\_\_ Seagrass bed: \_\_\_\_\_  
 Others (explain): \_\_\_\_\_ Windward: \_\_\_\_\_ Leeward: \_\_\_\_\_  
 Site description (15-20 words) : \_\_\_\_\_

S	Depth.	Substrates	%	Living Organisms	%	Other	No
0	Min:	Mud .....	....	Seagrass .....	....	Diadema	....
	.....	Sand .....	....	Brown algae .....	....	sea urchins	....
	Max:	Gravel and debris	....	Other algae .....	....	Other sea	....
		2 mm-5 cm .....	....	Alcyonaria (soft coral) .....	....		
	.....	Small boulders 5-30 cm	....	Encrusting coral .....	....	urchins	....
		Large boulders 30-100 cm	....	Massive or sub-massive coral	....	Sea	....
		Rock .....	....	Branch coral .....	....		
		Slab .....	....	Table coral .....	....	Other	....
		Dead coral .....	....	Leaf coral .....	....		
				Millepora .....	....		
				Mushroom coral .....	....		
1	Min:	Mud .....	....	Seagrass .....	....	Diadema	....
	.....	Sand .....	....	Brown algae .....	....	sea urchins	....
	Max:	Gravel and debris	....	Other algae .....	....	Other sea	....
		2 mm-5 cm .....	....	Alcyonaria (soft coral) .....	....		
	.....	Small boulders 5-30 cm	....	Encrusting coral .....	....	urchins	....
		Large boulders 30-100 cm	....	Massive or sub-massive coral	....	Sea	....
		Rock .....	....	Branch coral .....	....		
		Slab .....	....	Table coral .....	....	Other	....
		Dead coral .....	....	Leaf coral .....	....		
				Millepora .....	....		
				Mushroom coral .....	....		
2		Mud .....	....	Seagrass .....	....	Diadema	....
		Sand .....	....	Brown algae .....	....	sea urchins	....



***To find out more...  
... about tropical fish and invertebrates***

***In English***

**Fishes of the Great Barrier Reef and Coral Sea.** John E. Randall, Gerald R. Allen and Roger C. Steene. University of Hawai'i Press, 2840 Kolowalu Street, Honolulu, Hawaii 96822. ISBN 0-8248-1895-4 (1997).

**Coral Reef Fishes, Indo-Pacific and Caribbean.** Ewald Lieske and Robert Myers. Harper Collins publishers, 77-85 Fulham Palace Road, London W6 8JB, UK. ISBN 0-00-219974-2 (1994).

**Micronesian Reef Fishes.** Robert F. Myers. Coral Graphics, P.O. Box 21153, Guam Main Facility, Barrigada, Territory of Guam 96921, USA. ISBN 0-3621564-5-0 (1999).

**Tropical Pacific Invertebrates.** Patrick L. Colin and Charles Arneson. Coral Reef Press, 270 North Canon Drive, Suite 1524, Beverly Hills, California 90210, USA. ISBN 0-9645625-0-2 (1995).

**FishBase 2000.** CD ROM. c/o ICLARM, MCPO Box 2631, 0718 Makati City, Philippines. (This database can also be consulted on the Internet at the following URL: <http://www.fishbase.org>).

**Length-Weight Relationship of Fishes from Coral Reefs and Lagoons of New Caledonia – An Update.** Letourneur, Y., M. Kulbicki, and P. Labrosse. NAGA, the ICLARM quarterly (21)4: 39-46 (1998).

**FISHEYE, database on fish in the South Pacific.** IRD (formerly ORSTOM). (This database can also be consulted on the Internet at the following URL: <http://noumea.ird.nc/BASE/FISHEYE>).



***In French***

Poissons de Nouvelle-Calédonie. Pierre Laboute et René Grandperrin. Editions Catherine Ledru, 13 rue Victor Hugo, Baie de l'Orphelinat, 98 800 Nouméa, Nouvelle-Calédonie. ISBN 2-9505784-3-8 (2000).

FISHEYE, base de connaissances sur les poissons du Pacifique Sud. IRD (anciennement ORSTOM), base de données consultable sur Internet à l'adresse suivante :  
<http://noumea.ird.nc/en/BasCo.html>

Guide des poissons des récifs coralliens, région Caraïbes, océan Indien, océan Pacifique, mer Rouge. Ewald Lieske et Robert Myers. Delachaux et Niestlé (Eds), 79 route d'Oron, 1000 Lausanne 21, Suisse. ISBN 2-603-00982-6 (1995).

***... about Underwater Visual Census***

***In English***

Manual for Assessing Fish Stocks on Pacific Coral Reefs. Melita Samoily (ed). Department of Primary Industries, GPO Box 46, Brisbane Qld 4001, Australia. ISBN 0812-000, ISBN 0-7242-6774-3 (1997).

Survey Manual for Tropical Marine Resources (2nd Edition). S. English, C. Wilkinson and V. Baker (eds). Australian Institute of Marine Science, Townsville, Queensland, Australia. ISBN 0-642-25953-4 (1997).

Evaluation of Sampling Methods for Reef Fish Populations of Commercial and Recreational Interest. Cappo M., Brown I.W. CRC Reef Research Technical Report n°6. ISBN 1 876054 06 9 (1996).

***In French***

Évaluation visuelle des peuplements et populations de poissons : méthodes et problèmes. M.L. Harmelin-Vivien, J.G. Harmelin, C. Chauvet, C. Duval, R. Galzin, P. Lejeune, G. Barnabé, F. Blanc, R. Chevalier, J. Duclerc, G. Laserre. Revue d'Écologie (Terre Vie), Vol. 40, 1985.