

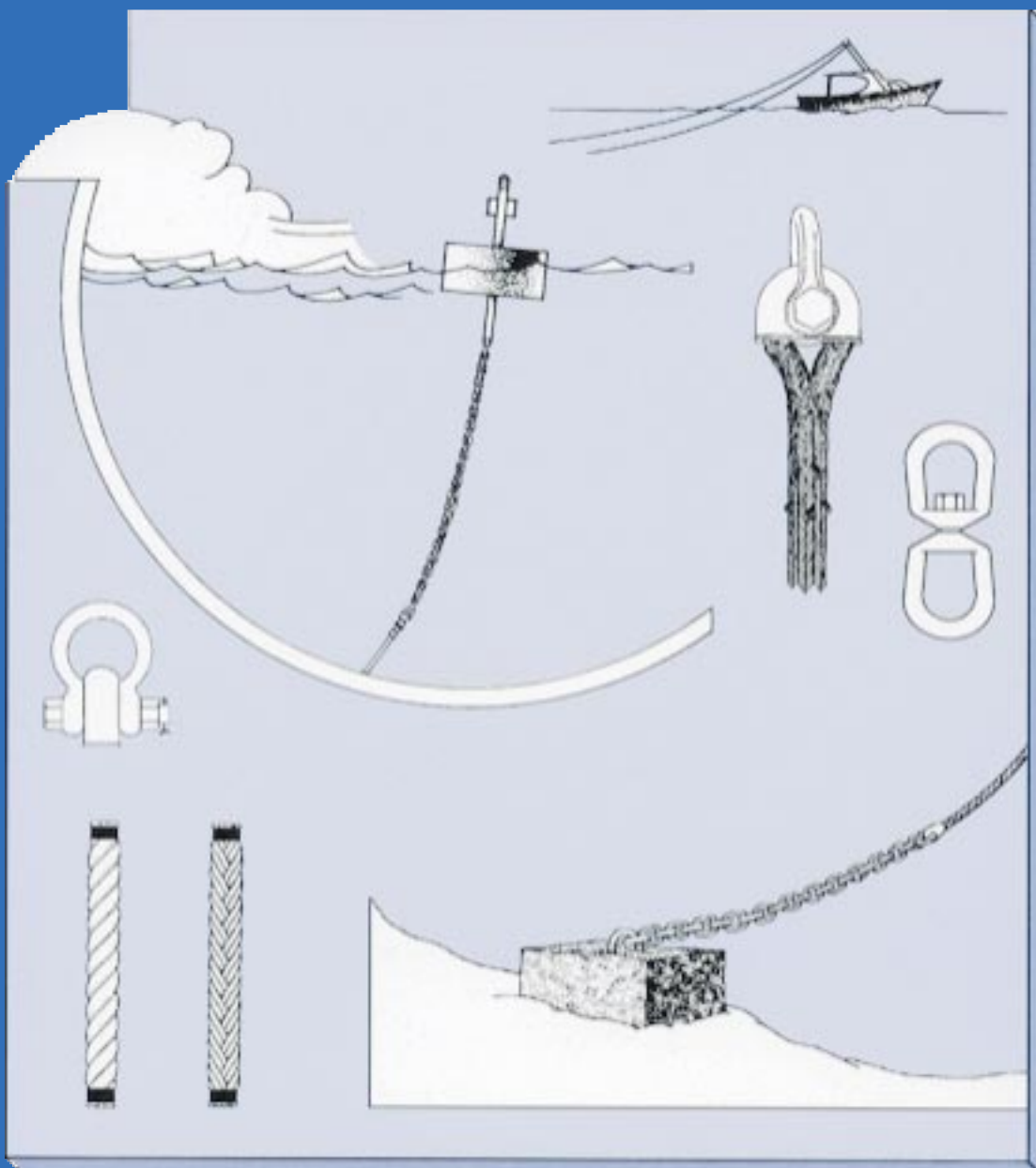

# SOUTH PACIFIC COMMISSION FISH AGGREGATING DEVICE (FAD) MANUAL

## VOLUME II RIGGING DEEP-WATER FAD MOORINGS



# **SOUTH PACIFIC COMMISSION FISH AGGREGATING DEVICE (FAD) MANUAL**

## **VOLUME II RIGGING DEEP-WATER FAD MOORINGS**

BY

PAUL GATES,<sup>1</sup> PETER CUSACK<sup>2</sup> AND PETER WATT<sup>3</sup>

**COASTAL FISHERIES PROGRAMME  
CAPTURE SECTION**



SOUTH PACIFIC COMMISSION  
NOUMEA, NEW CALEDONIA



---

© Copyright South Pacific Commission 1996

The South Pacific Commission authorises the reproduction of this material, whole or in part, in any form, provided appropriate acknowledgement is given.

Original text: English

South Pacific Commission Cataloguing-in-publication data

South Pacific Commission fish aggregating device (FAD) manual / Paul Gates . . . [et al.]

Contents: v.i. Planning FAD programmes—v.ii. Rigging deep-water FAD moorings—v.iii. Deploying and maintaining FAD systems

1. Fish aggregating device—Handbooks, manuals, etc.
2. Fisheries—Equipment and supplies. I. South Pacific Commission Coastal Fisheries Programme Capture Section.

639.2028

AACR2

ISBN 982-203-482-2 (set)

ISBN 982-203-482-0 (v. ii)

Authors

1. Paul Gates, former SPC Fisheries Development Officer, tragically lost in a diving accident off Guam in 1994
2. Peter Cusack, Fisheries Development Adviser, South Pacific Commission, B.P. D5, 98848 Noumea Cedex, New Caledonia.
3. Peter Watt, former SPC Masterfisherman, now fisheries consultant, 18 Mariposa St., Cubao, Quezon City, Metro Manila 1109, Philippines

Prepared for publication, with the assistance of the Fisheries Information Section, and printed at South Pacific Commission headquarters, Noumea, New Caledonia.

Cover printed by Stredder Print Limited, Auckland, New Zealand,

1996

---

*Dedication*

*The SPC Fish Aggregating Device (FAD) Manual  
is dedicated to the memory of Paul Gates, former SPC Fisheries Development Officer  
and later consultant to the Commission, who devoted  
a large part of his professional career to this work.  
His original research, writings and artwork  
have been drawn on heavily in its production.*

---

## Acknowledgements

The South Pacific Commission acknowledges with gratitude the assistance of the many persons who contributed to the production of this guide. Particular thanks are due to Lt. Cmdr. Richard Boy of the United States Coast Guard; Bob Pollock of Continental Western Corporation, Portland, USA; Aymeric Desurmont of the *Service territorial de marine marchande et des pêches maritimes*, New Caledonia; Michel de San and Erik Rotsaert of the *Projet de développement de la pêche artisanale aux Comores*; Marc Taquet and Gérard Biais of *IFREMER*, La Réunion; and the staff of the many Pacific Island fisheries departments who worked with SPC in the development and refinement of the FAD systems described here.

Research and publication were made possible by funding assistance from the Australian Government through AusAID and the United Nations Development Programme.

Artwork and graphics are by Yannic LeBars, Jean-Pierre LeBars and Marie-Ange Roberts.

---

## CONTENTS

INTRODUCTION	1
THE SPC FAD SYSTEMS	3
FAD RAFTS	4
THE SPC STEEL SPAR BUOY	4
Construction details for steel spar buoy	7
Cutting components	8
<i>Outer buoy wall</i>	8
<i>Mast and attachment spar</i>	8
<i>Hull</i>	8
Fabricating the buoy	8
<i>Base plate and spar</i>	8
<i>Compartment walls</i>	8
<i>Outer buoy wall</i>	9
<i>Buoy top plates</i>	9
<i>Leak-test fittings</i>	9
<i>Lifting eye</i>	10
<i>Support gusset</i>	10
<i>Mooring padeye</i>	10
<i>Combination 3-plane radar reflector and dayshape</i>	11
<i>Handling eyes</i>	11
<i>Flashing light</i>	11
THE SPC INDIAN OCEAN FAD RAFT	12
Detail of mast-mooring connection	15
Detail of eye splice rigging at either end of float cable	16
Detail of mast arrangement	17
FAD MOORING COMPONENTS	18
THE CATENARY CURVE MOORING SYSTEM AND ITS COMPONENTS	18
Steel spar buoy FAD system mooring arrangement	20
Steel spar buoy system components	21
Indian Ocean FAD system mooring arrangement	22
Indian Ocean FAD system components	23
RECOMMENDED HARDWARE COMPONENTS FOR SPC FAD SYSTEMS	24
Anchor-type safety shackle	24
Chain	25
<i>Recognising poor-quality chain</i>	25
Swivels	26
Rope connectors	27
Float cable	28
Cable clamps	28
Thimbles	28
Appendages	29
<i>Steel spar buoy system appendages</i>	29
<i>Indian Ocean FAD system appendages</i>	29

---

HARDWARE CONNECTIONS	30
Chain–shackle connections	30
Shackle–swivel connection	30
Swivel–rope connector connections	30
<b>ROPES</b>	<b>31</b>
<b>ROPE RECOMMENDATIONS</b>	<b>31</b>
<b>ROPE MATERIAL</b>	<b>32</b>
Nylon	32
Polypropylene	32
<b>ROPE CONSTRUCTION</b>	<b>33</b>
Breaking strength	33
Twisting, kinking and hockling	34
Features of plaited ropes	34
Load distribution and breaking points	34
<b>ROPE SIZE AND WEIGHT</b>	<b>35</b>
<b>MOORING CALCULATION</b>	<b>36</b>
<b>ROPE LENGTHS</b>	<b>36</b>
<b>SUPPLEMENTARY BUOYANCY</b>	<b>37</b>
The use of pressure-resistant floats	37
Float attachment	
<b>ANCHORS</b>	<b>39</b>
<b>PRINCIPLES FOR ANCHOR CONSTRUCTION</b>	<b>39</b>
<b>CONSTRUCTION OF CONCRETE ANCHOR</b>	<b>41</b>
Anchor attachment point (bail)	41
Reinforcing concrete anchors	41
Forms	41
Mixing concrete	42
<b>CONVERSION TABLES</b>	<b>43</b>

---

## INTRODUCTION

In the region served by the South Pacific Commission the use of fish aggregating devices, or FADs, is widespread. Twenty of the Commission's twenty-two member countries and territories are known to have made use of these devices at one time or another, and the majority maintain ongoing FAD programmes.

Since the introduction of FADs into the Pacific from the Philippines in the late 1970s, regional FAD experience has passed through several distinct phases. Between 1979 and 1983, FAD effort centred on modifying the traditional Filipino payao system to withstand the harsher, deeper-water, high-energy ocean environments typical of the Pacific. The second period, from 1984 to 1990, saw the introduction and widespread adoption of the inverse catenary curve mooring system\*. Since that time, development efforts have focused on refinement of the inverse catenary curve mooring, the development of strict material specifications, improvement of buoy technology, and establishment of sound procedures for FAD site surveys and deployments.

The early period of FAD use was characterised by unrefined technology, a lack of criteria for mooring and buoy design, and lack of standards for mooring components. As a result, FAD losses were high, and lifespans were generally short. The average lifespan in mid-1983 was only six months. Although FADs quickly became popular with fishermen, the high loss rates, relatively short lifespans, and high unit costs created concern: did the benefits realised from FADs really outweigh the costs of setting them in place? National planners and donor agencies grew reluctant to fund FAD programmes because FAD deployments required recurrent funding. FAD catch-and-effort data from fishermen, which could have helped justify FAD funding, were usually not collected.

In 1983, this situation prompted the South Pacific Commission (SPC) to undertake a region-wide FAD research and development project. The project's central objective was to advance FAD technology to a level that would assure a two-year average lifespan for FADs, while maintaining unit costs at the then regional average of US\$ 3,000. Such a lifespan and cost ratio were considered the minimum necessary to determine that FADs deployed for artisanal fisheries enhancement would be worthwhile investments.

The project's primary focus was the improvement of FAD moorings, and to this end an ocean mooring expert was engaged. This work included country visits and a region-wide review of FAD experience to assess system designs and fabrication and deployment practices. The project culminated in the publication of a FAD handbook, *Design improvements to fish aggregation device (FAD) mooring systems in general use in Pacific Island countries* (Smith & Boy, 1984). The handbook introduced the inverse catenary curve mooring system, a design based on proven deep-water buoy mooring technology, and made specific recommendations as to type, material, size, and strength, for all mooring components.

### \* INVERSE CATENARY CURVE MOORINGS

The essential feature of the inverse catenary curve mooring is the use of sinking rope in the upper part of the mooring, combined with floating rope in the lower part, to form a reserve of rope that is held at a specified depth below the surface. This provides scope, or slack, in the mooring to cope with the stresses of currents and wave action. The floating rope in the lower mooring also serves to buoy up the bottom chain and hardware, thus ensuring that the rope does not contact the sea floor and so come in danger of abrasion.



The catenary curve mooring design and the recommended component specifications were progressively adopted throughout the region. By 1989, most countries had confirmed that FAD lifespans were generally longer, and some FADs had survived two years or more. However, it was clear that an overall average two-year lifespan had still not been achieved. FAD costs had also increased. In some countries where short FAD lifespans were the norm, the unfavourable relationship between life expectancy and cost led to major cutbacks in FAD deployments. FADs had become even more popular with fishermen, however, as awareness of effective FAD-based fishing methods spread through the work of the SPC Fisheries Programme and others.

These events led to the most recent phase of FAD development. In May 1990, at the request of its members, SPC mounted a further region-wide FAD development effort. This work sought to improve FAD technology through practical research, including the development of improved raft designs; improvement of the flow and exchange of technical information on FAD development; and the training of regional FAD technicians in sound FAD practice and skills.

The SPC FAD manual arises from that work. It will be published in three volumes and provide a comprehensive guide to all important aspects of FAD use.

This volume, *Rigging deep-water FAD moorings*, gives a detailed technical guide to the rigging of two recommended deep-water FAD systems, each of which has been extensively tested in the field. It follows publication of Volume 1 in the series, *Planning FAD programmes* (Anderson & Gates, 1996) which describes procedures for sound FAD programming and the monitoring and appraisal of the effects of FAD use. The third volume, *Deploying and maintaining FAD systems*, will deal with FAD site selection, site survey, and deployment and maintenance techniques.

The present volume limits itself to presenting specifications and rigging details for two mooring systems considered suitable for the majority of deep-water deployments in the region (700 m and more). It is important to note that the successful use of these designs is dependent on the strict use of the materials recommended. Use of a specified set of mooring components with established weights and other characteristics allows for simplification of the otherwise complex task of rope length calculation.

This volume is thus able to provide a calculated table of mooring rope lengths for varying site depths. However, if different types of rope, or hardware with substantially different specifications, are substituted in place of those recommended, then the FAD may not perform as expected and may suffer early failure.

It is hoped that the information presented here will enable countries embarking on FAD programmes to benefit from SPC's close association with Pacific FAD experience over the last 15 years and that longer FAD lifespans and increased benefits from FAD use will result.

## THE SPC FAD SYSTEMS

This volume describes two proven FAD mooring systems, **the SPC steel spar buoy FAD** and **the SPC Indian Ocean FAD**, which are rigged from standardised components available to the Pacific region from sources in Australia, New Zealand and the USA. Both of the systems described make use of the inverse catenary curve mooring. They differ only in the raft, or floating surface part, and the uppermost part of the sub-surface mooring. Each system has advantages of cost or ease of construction in particular circumstances.

The development of these two raft types followed the wide, and mostly successful, adoption of the catenary curve FAD mooring. As FAD systems began to remain on station for longer periods, it soon became apparent that many FAD rafts commonly in use were inadequate, and that the technical characteristics of successful FAD raft designs were not well understood. In some cases, rafts were breaking up well before moorings failed. In response, SPC research into raft design focused on development of flotation systems that would perform adequately, last at least as long as moorings, be as low-cost as possible, and be suited to local construction capabilities.

The two raft designs, and the associated variations in the standard catenary curve mooring, have been widely deployed in the Pacific Islands. The systems are not the cheapest that can be deployed, but when rigged properly (and barring vandalism, fish bite and severe cyclonic storms) are considered likely to provide two years or more of service.

The following sections of this manual describe the materials, components, and construction and rigging methods required to assemble the two SPC-recommended systems. The manual begins by describing construction and rigging of the two alternative surface rafts, then works on down through rigging of the main mooring (including alternative upper mooring suited to each raft type) and construction of a standard anchor.

Note: Most measurements in this manual are given in metric. For the convenience of those accustomed to working with U.S. measures, a conversion table is provided on page 43.

---

## FAD RAFTS

All FAD rafts serve two basic purposes apart from their part in aggregating fish; they support the mooring and they enable fishermen to locate the FAD. If a FAD raft breaks up, the FAD is effectively lost, even though the mooring may remain anchored to the bottom. A FAD raft's most important characteristic, then, is that it will survive in the sea for at least as long as the mooring.

The open-ocean locations in which FADs are typically deployed in the Pacific are high-energy environments. Many areas experience seasonal trade winds and periods of rough seas generated by cyclones and tropical storms. To survive in these conditions, FAD rafts must be constructed of durable materials that will not wear or corrode readily, so as to ensure the raft's buoyancy. In some areas FAD rafts may be prone to interference or vandalism; in others, they may be required by marine by-laws to carry lights and radar reflectors. These requirements, along with cost, ease of construction, and availability of materials and components, set certain design criteria.

The two raft designs described here have been developed by the SPC Fisheries Programme in accordance with sound buoy engineering principles and a close knowledge of FAD use and capabilities in the Pacific region. Both raft types have been tested in the field and are recommended as suitable for all deep-water FAD use.

### THE SPC STEEL SPAR BUOY

The SPC steel spar buoy was designed at SPC's request by Lt Cmdr Richard Boy of the United States Coast Guard, as a robust, long-lasting raft, capable of carrying both a navigation light and a radar reflector, and within the construction capabilities of small steel fabrication workshops. It is a non-directional, wave-riding buoy fabricated from steel.

The design features the high buoyancy-to-drag ratio characteristic of wave-riding buoys. The buoyancy provided by the size of the hull is sufficient to support the weight of the buoy itself and the upper mooring, which includes 15 m of chain and a section of nylon rope. In addition sufficient **reserve buoyancy** is provided to ensure that the buoy is not submerged when the mooring is fully extended under the effect of currents, winds or high seas.

Anti-flooding and anti-capsizing features are incorporated in the buoy design. The hull is divided into three separate compartments, each of which can be leak-tested before the buoy is deployed. If cracks form in the hull or welded seams, flooding is likely to be confined to a single compartment, which reduces the chances of loss of the buoy and the mooring.

A single 345 cm length of 10 cm galvanized steel pipe forms both the buoy's mast and its mooring attachment point. The mooring attachment spar which extends below the buoy, the mooring attachment pad-eye, and the weight of the upper chain collectively function to stabilise the buoy and provide a righting capability that prevents capsizing.

The single-piece, through-pipe, combination mast and mooring attachment, the compartment walls of the hull, and the support gussets, provide strength to the mooring attachment and reduce the chance of the pipe being bent as it works to right the buoy in rough seas. The design also includes a set of sturdy lifting eyes which make it possible to load and deploy the buoy without damaging it.

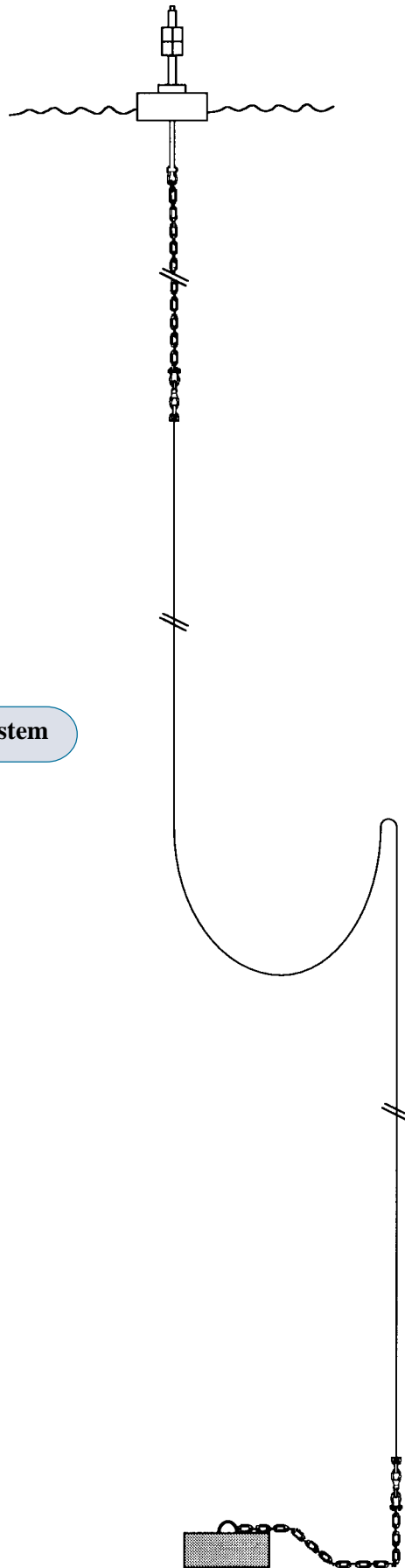

The SPC steel spar buoy FAD system

**STEEL SPAR BUOY****ADVANTAGES**

Most Pacific island countries have steel fabrication workshops equipped to build this raft.

The specified steel plate and the pipe used in the spar are commonly available.

The design allows for incorporation of location aids, including a simple, combination three-plane radar reflector/dayshape and a battery-powered flashing light that fits into the pipe mast.

The buoy is very resistant to accidental or deliberate damage. The position and weight of the upper mooring chain make it very difficult to haul the mooring to reach the vulnerable rope section.

The buoy can support the weight of a man, allowing for easy servicing of the navigation light.

Little maintenance is required for the steel hull.

Hull compartmenting reduces the likelihood of a single leak flooding the buoy.

Added flotation, in the form of buoyant foam filling, is not required.

**DRAWBACKS**

Material costs are relatively high; in some areas the skilled labour required for construction will increase costs significantly.

Battery-powered lights are expensive and are easily vandalised or removed.

Batteries must be replaced regularly.

Inspection and servicing of the upper mooring require a diver or the availability of a vessel with lifting gear.

A relatively large vessel is required to transport the buoy to the deployment site.

The robust appearance of the buoy increases the likelihood that fishing craft will tie off to it.

The hull requires coating with marine-grade paints to minimise corrosion.

Construction details for steel spar buoy

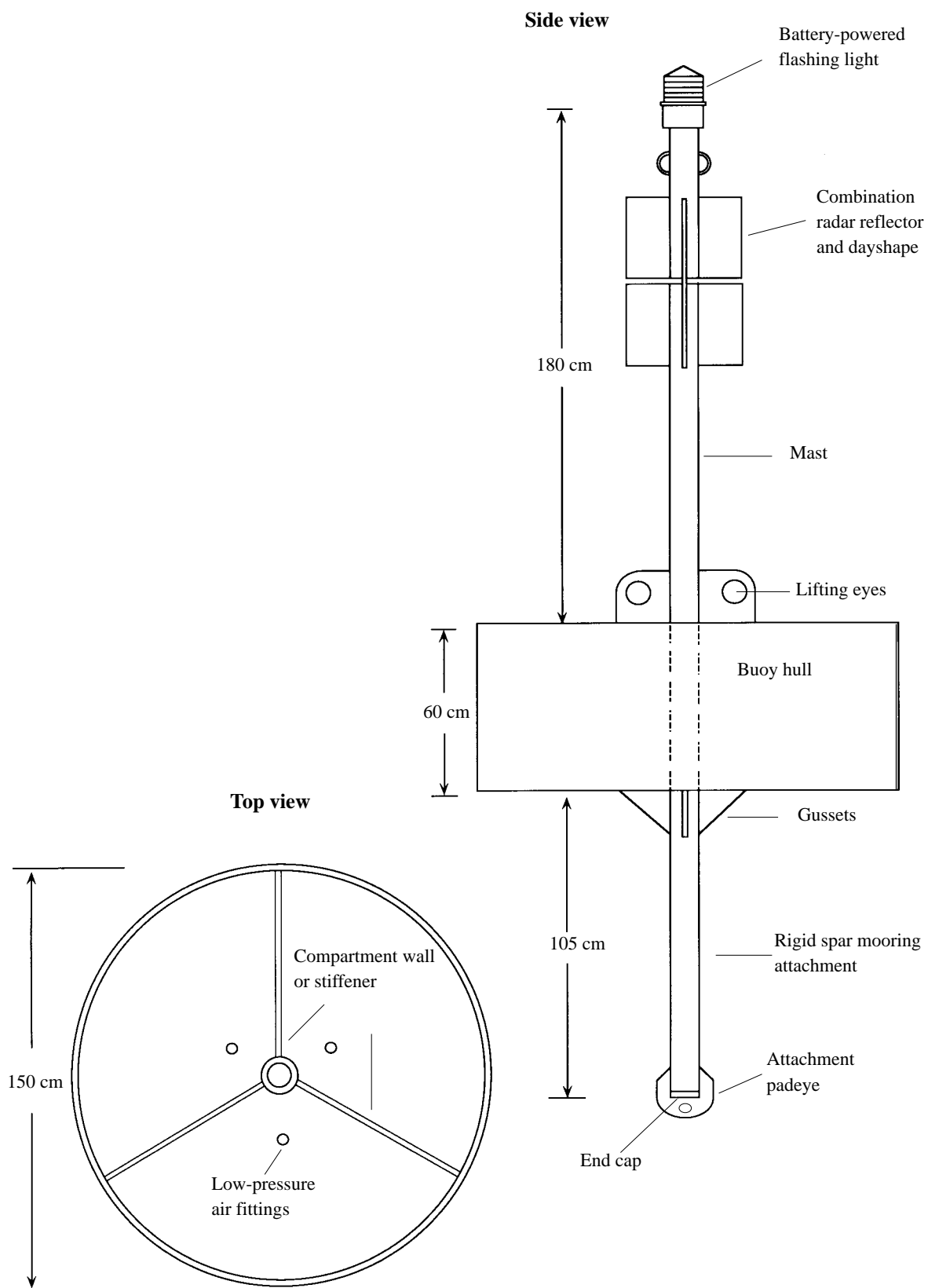

## Cutting components

### Outer buoy wall

Cut the outer buoy wall from 5 mm steel plate, 60 cm by 480 cm.

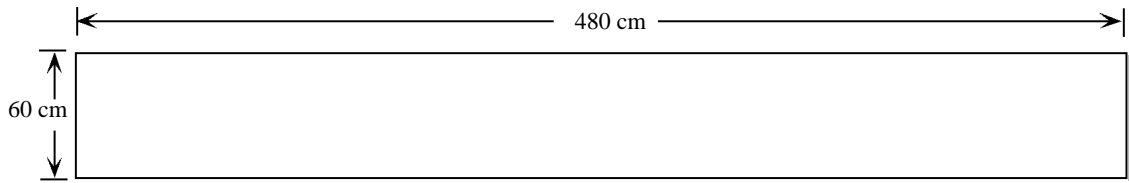

### Mast and attachment spar

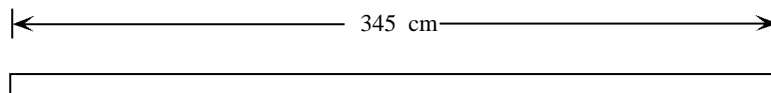

The combination mast–mooring attachment spar is constructed from a single piece of 10 cm, schedule 40, pipe, 345 cm long.

### Hull

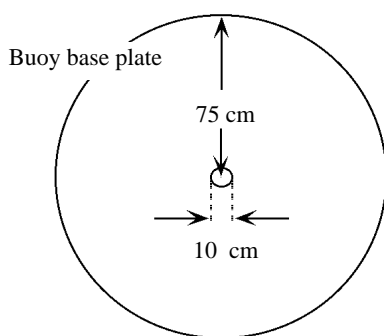

Cut a circular base plate of 75 cm radius from 5 mm steel plate. Cut a 10 cm diameter hole at the plate centre for the through-pipe mast.

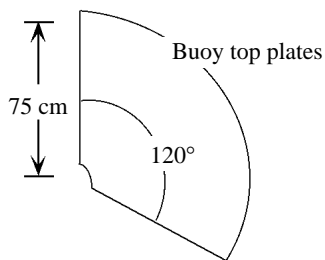

Cut 3 top plates of 75 cm radius and 120° arc from 5 mm steel plate. Cut a 5 cm radius arc from the inner point of each plate.

Compartment walls

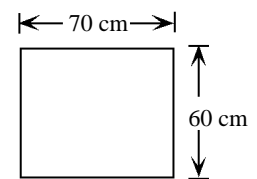

Cut 3 walls of 60 cm x 70 cm from 5 mm steel plate.

## Fabricating the buoy

### Base plate and spar

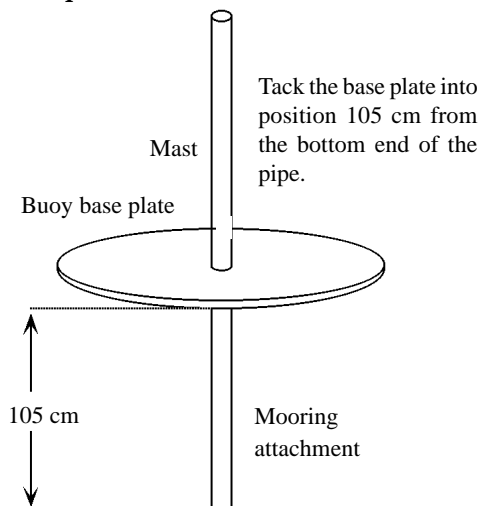

### Compartment walls

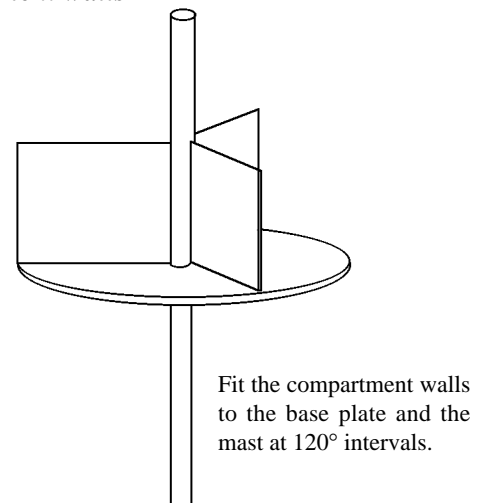

**Outer buoy wall**

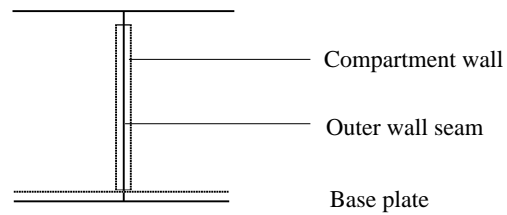
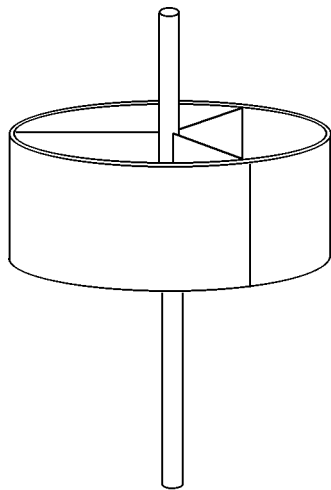

Fit the outer buoy wall into place, butted against the base plate, and level with the top edge of the compartment walls. Orient the outer buoy wall so that the two ends will meet along a compartment wall. After the outer wall is fitted, weld along all seams.

**Buoy top plates**

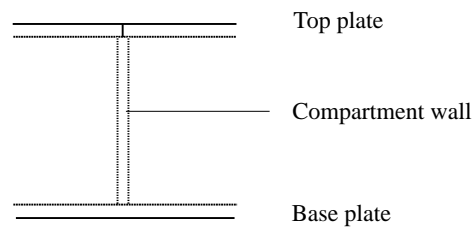
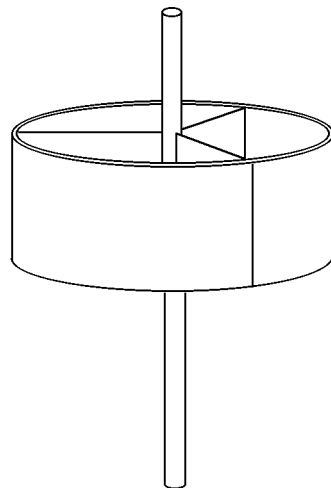

Fit the three top plates onto the buoy, flush with the top edge of the outer buoy wall and with both edges aligned with compartment walls. Leave a slight gap between the edges of adjacent plates. Weld the plates so that the weld seals off each compartment and renders it watertight.

**Leak-test fittings**

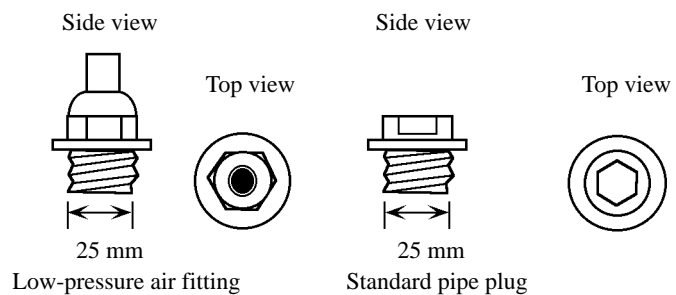
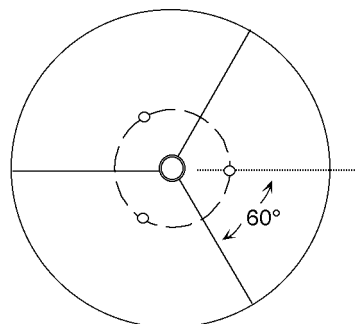

Drill and thread a 25 mm diameter hole along the midline, 20–25 cm from the mast in each top plate. Screw a 25 mm low-pressure air fitting into each hole and leak-test each compartment. When all compartments are watertight, replace the air fitting with a standard 25 mm pipe plug.



**Lifting eye**

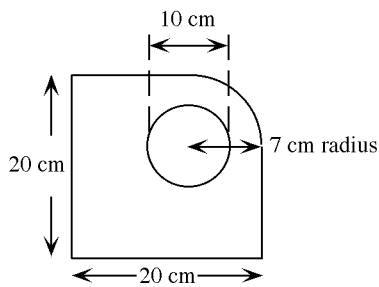

Fabricate 2 lifting eyes from 5 mm steel plate.

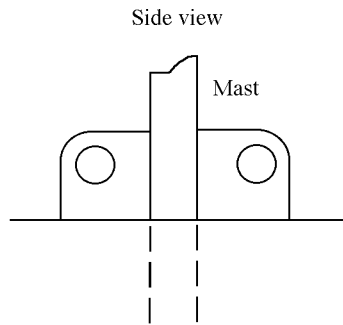

Orient lifting eyes opposite each other, against the buoy hull on either side of the mast.

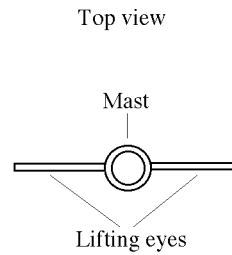

**Support gusset**

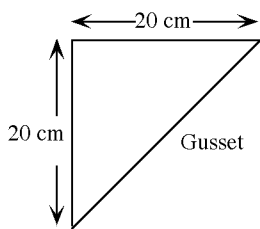

Fabricate 4 gussets from 5 mm steel plate.

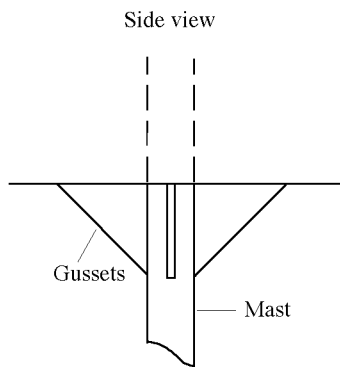

Orient gussets at right angles to each other, weld the top edge to the base of the buoy hull and weld the upright side to the mast.

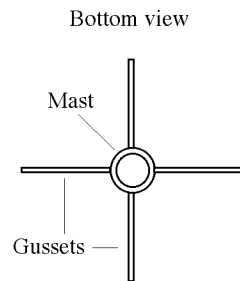

**Mooring padeye**

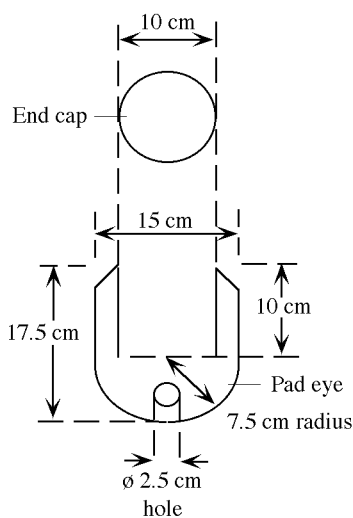

Fabricate the end cap and padeye from 25 mm steel plate.

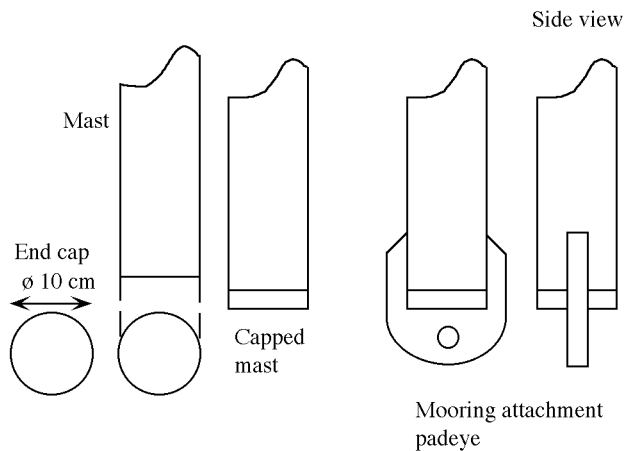

Seal the mast with the end cap, then centre the padeye on the capped mast and weld it into place.

**Combination 3-plane radar reflector and dayshape**

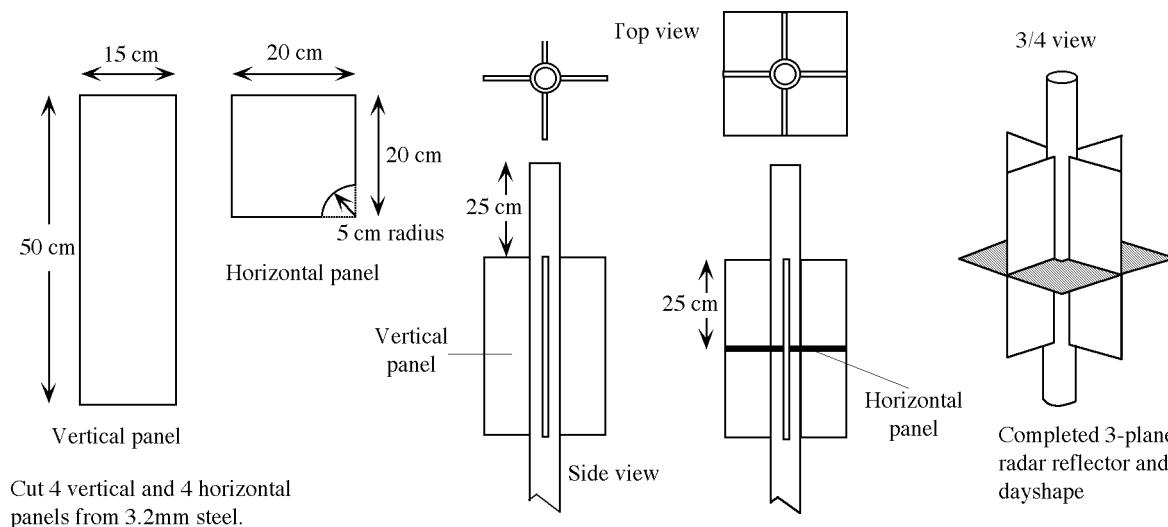

Weld vertical panels to the mast at right angles to each other, with the tops 25 cm from the top of the mast. Then centre and weld horizontal panels between pairs of vertical panels.

**Handling eye**

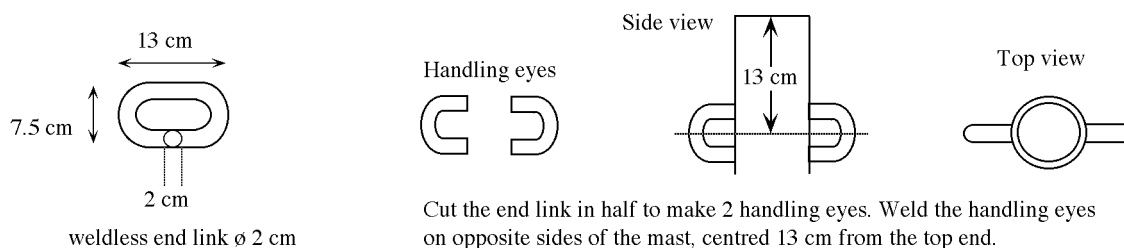

Cut the end link in half to make 2 handling eyes. Weld the handling eyes on opposite sides of the mast, centred 13 cm from the top end.

**Flashing light**

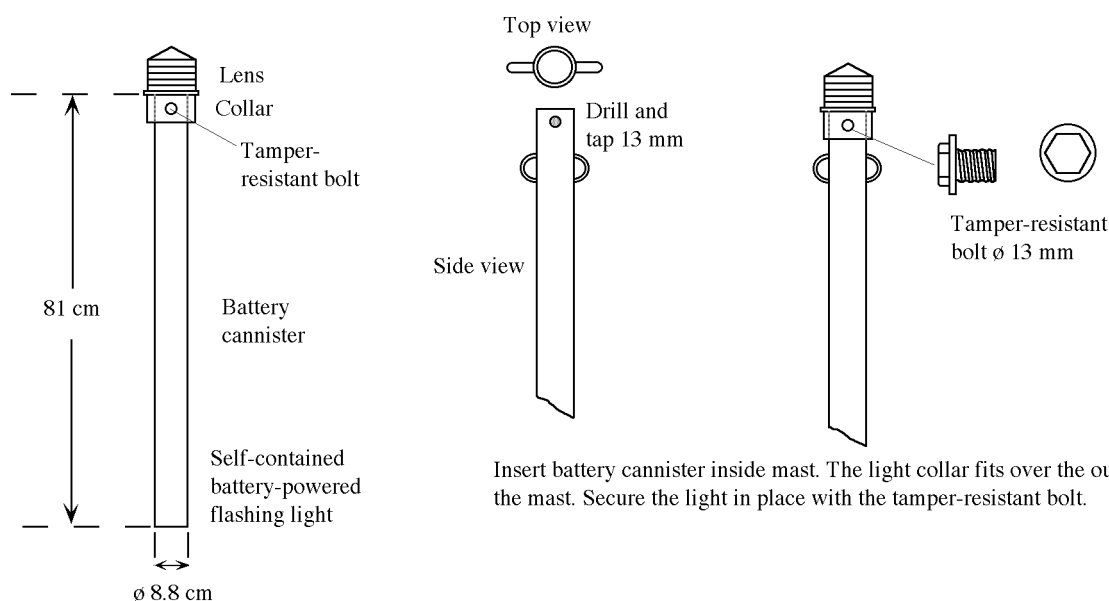

Insert battery cannister inside mast. The light collar fits over the outside of the mast. Secure the light in place with the tamper-resistant bolt.

## THE SPC INDIAN OCEAN FAD RAFT

In 1990, reports circulated in the Pacific about an innovative, light-weight FAD raft in use in some French territories in the Indian Ocean. The raft, specifically designed for deployment in areas where strong currents are common, consisted of a string of hard plastic, pressure-resistant floats strung on a length of steel wire rope. The low drag and buoyancy of this type of raft was said to place less strain on the mooring under the effect of strong surface currents. In extreme currents, the raft was said to submerge without damage and resurface when currents eased.

SPC trials with modified versions of this design, incorporating inverse catenary curve moorings, indicated that this type of raft performed very well. The string of floats followed wave action closely and appeared to transfer very little dynamic action to the mooring, eliminating the slamming and jerking that is typical of single-hull rafts. No tendency for the rafts to submerge was apparent.

Several technical problems were encountered during these trials. The pressure-resistant floats tended to shatter easily when struck by a boat or when the breakdown of cushioning placed between them allowed them to come in contact with one another; they were readily abraded by the wire rope on which they were strung, and they proved to be both difficult to obtain and expensive.

Further trials were made with rafts rigged from strings of floats of other types. It was found that purse-seine net floats were ideal for this purpose, being relatively inexpensive, commonly available (at least in areas where purse-seine vessels operate) and extremely resistant to impact and abrasion. In combination with the use of a PVC-covered wire rope (developed as a foot rope for trawl nets) on which the floats were strung, a low-cost and robust raft was developed which retained the desirable characteristics of the Indian Ocean original.

The raft is rigged by stringing 50 purse-seine floats on a 30 m length of 16 mm steel wire rope with a covering of PVC. The purse-seine floats used in the SPC model are C6000 types manufactured by Casamar and have a buoyancy of 7 kg each. The 16 mm, 7-strand wire rope has an 8 mm thick coating of PVC bonded to it, making an outer diameter of 32 mm which fits snugly through the hole in the floats. The PVC is watertight.

In order to form eye splices at either end of the cable to make connections to the main mooring and mast, the steel wire core has to be exposed. To prevent corrosion, the exposed cable is wrapped with waterproof grease tape. The eye splices are formed around galvanized steel thimbles and secured with cable clamps. Narrow (25 mm) strips cut from disused automotive inner tube may also be stretched and wrapped tightly over these connections, in the manner of whipping, to protect the greased tape from wear and to further inhibit corrosion.

Because this type of raft cannot capsize, it is not necessary to provide a stabilising counterweight beneath it. Instead, the 15 m section of the PVC-covered wire rope that extends beyond the length required to accommodate the 50 floats is left to hang vertically. This serves to provide protection from fishing gear and vessels, in place of the usual upper mooring chain.

It is recommended that this raft be inspected regularly for signs of wear or corrosion and for the integrity of the eye-splices. Required maintenance should be carried out promptly. Because the raft is less expensive to rig, two complete rafts may be prepared for each FAD unit and one of these held in reserve on deployment.

If the deployed raft requires maintenance work at any time, it can be unshackled from the mooring and the reserve raft fitted in its place. This substitution can be handled from a small boat, because the raft is easily hauled, float by float, to reach the shackle connecting to the main mooring. A reserve raft, or one for repair, can be towed to or from the FAD site if the servicing craft is too small to carry the whole raft on deck.

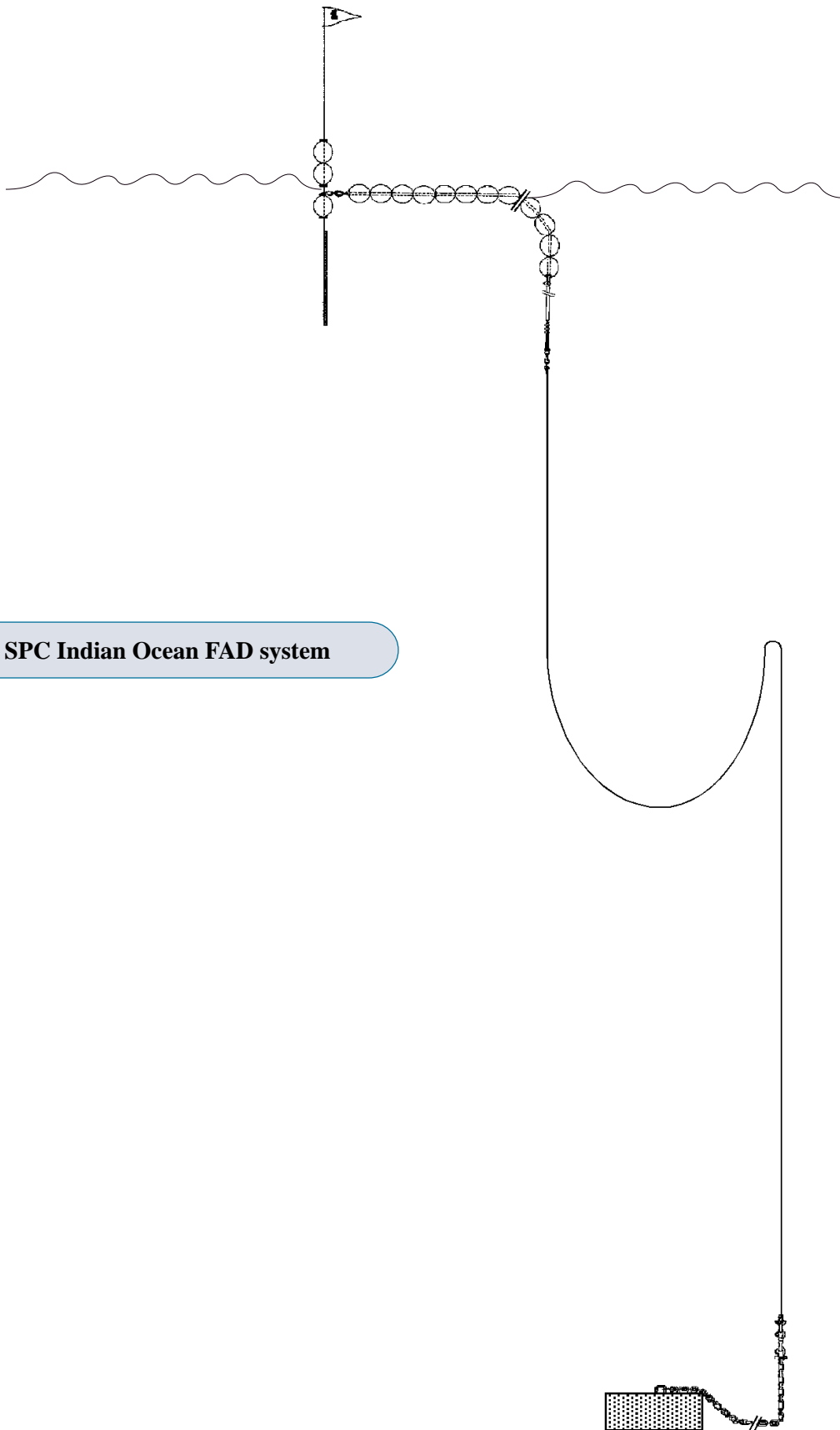

**The SPC Indian Ocean FAD system**

## INDIAN OCEAN FAD RAFT

### ADVANTAGES

Construction is simple, requiring only basic welding and rigging skills.

Wave-following action and low-drag profile transfer little stress to the mooring.

Buoyancy is assured for the life of the components.

The raft can be readily handled by relatively small craft for deployment and inspection.

Upper mooring chain is not required.

Replacement of a raft requiring maintenance, with a reserve unit, is relatively simple.

### DRAWBACKS

The raft's low profile and simple marker pole make it more difficult to locate than a spar buoy.

Fitting of location aids such as radar reflectors and lights is more difficult than for spar buoys.

Corrosion of the wire rope is possible and it is likely that this component of the raft will have a shorter service life than other parts.

Detail of mast/mooring connection

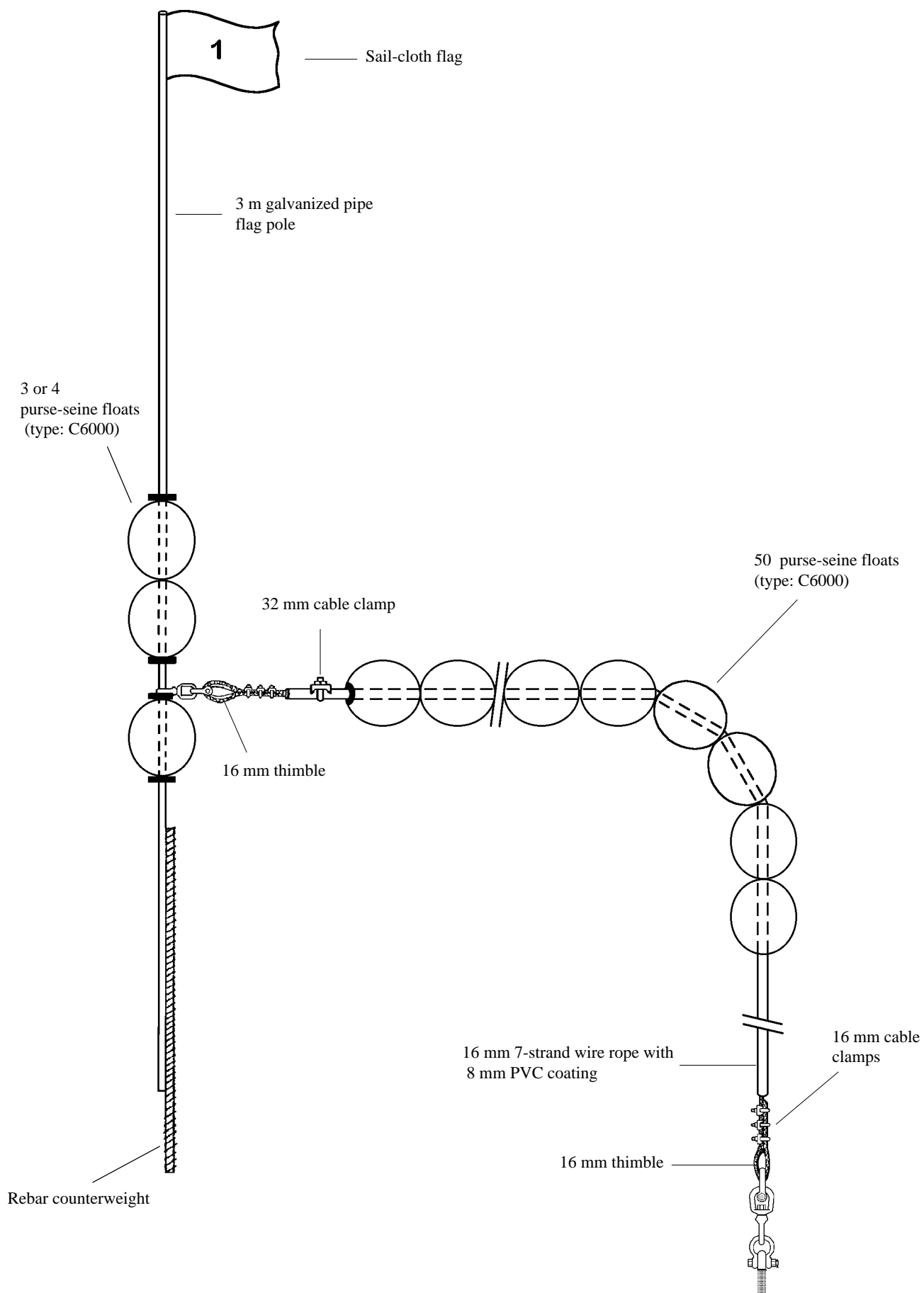

Detail of eye-splice rigging at either end of float cable

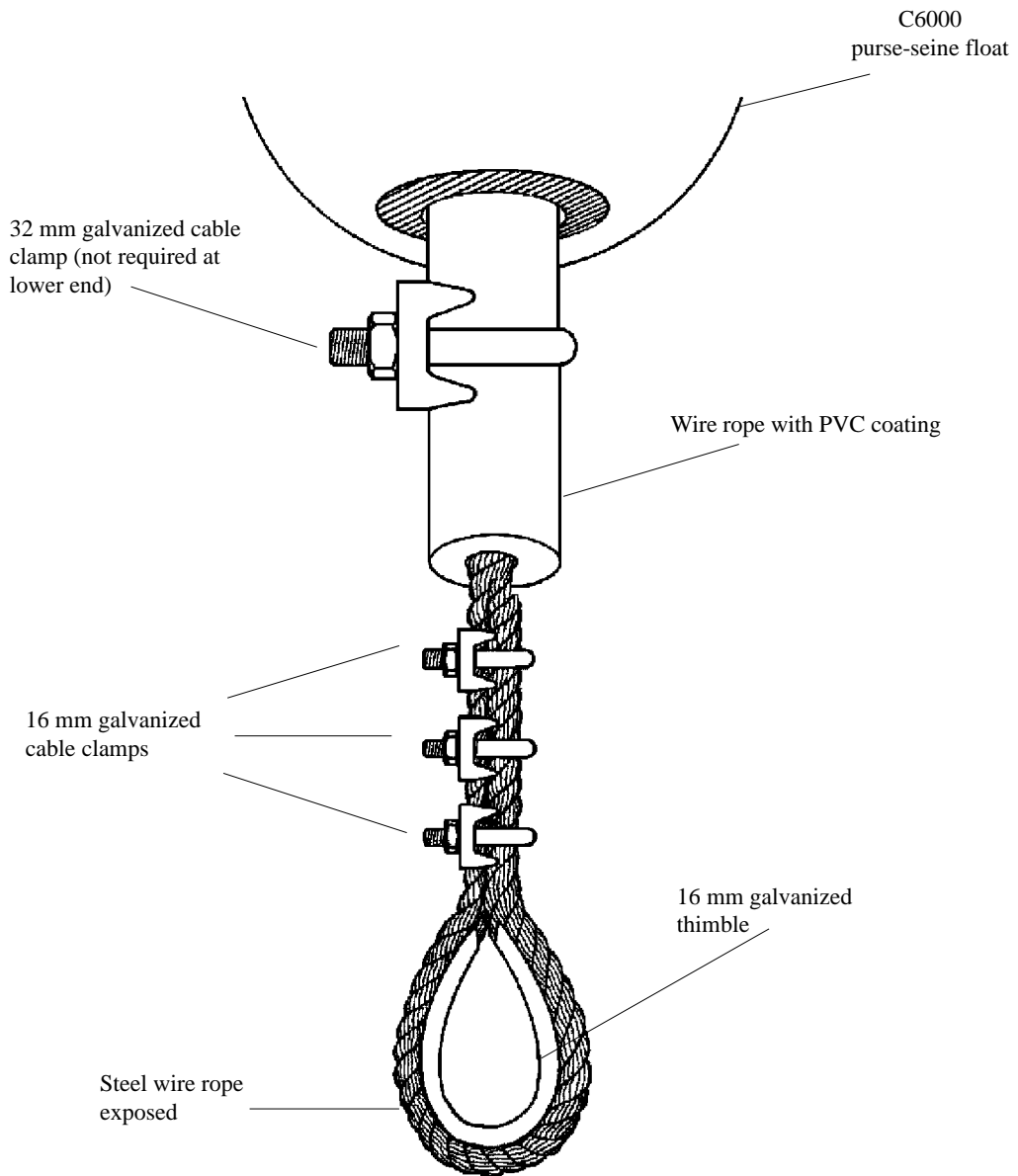

Detail of mast arrangement

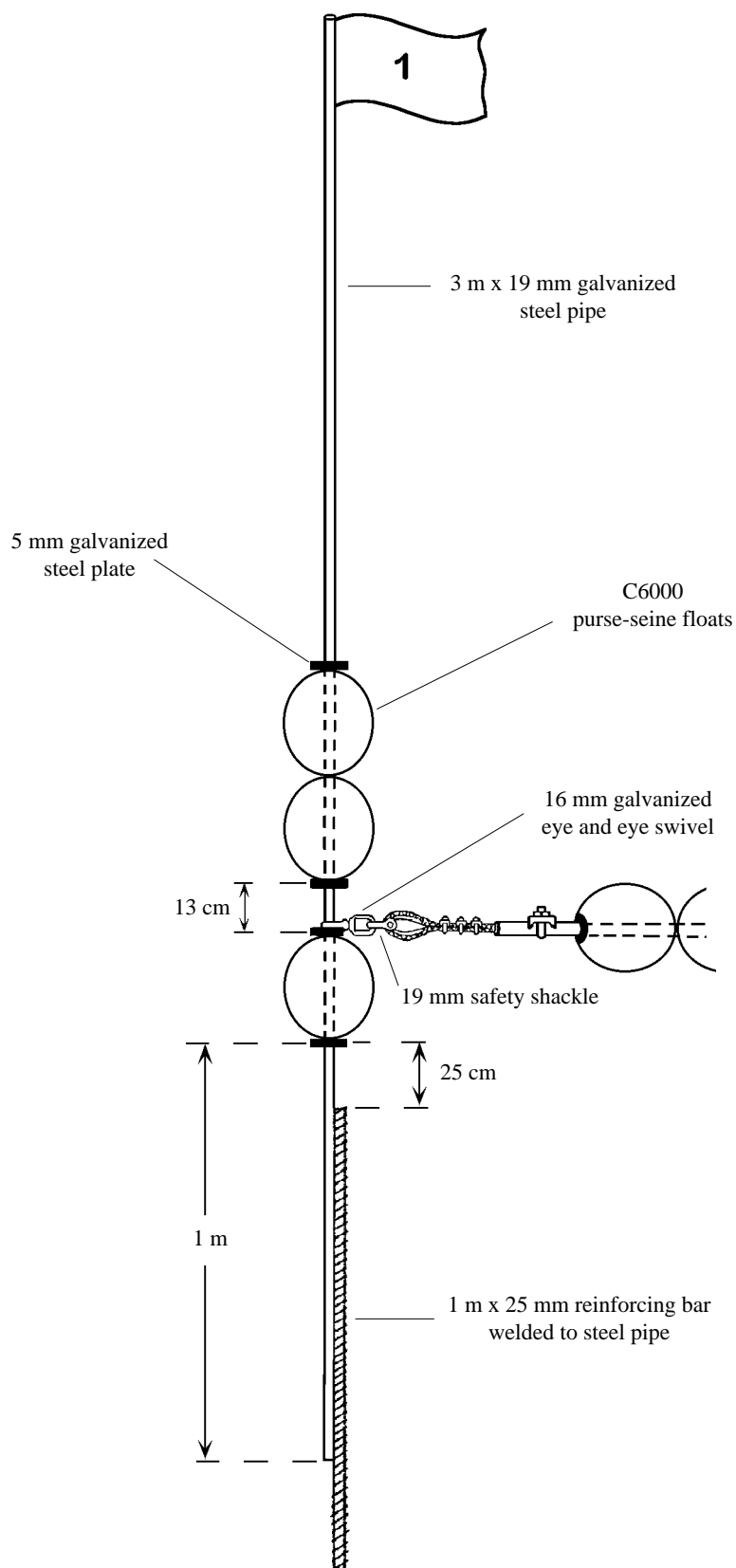



## FAD MOORING COMPONENTS

### THE CATENARY CURVE MOORING SYSTEM AND ITS COMPONENTS

Each of the SPC FAD systems incorporates an inverse catenary curve mooring. Catenary curve mooring can be considered to consist of three separate sections: the upper mooring, the catenary curve, and the lower mooring. Each section is important to the function of the mooring.

The upper mooring section consists of a chain, or wire rope, sinking nylon rope and connecting hardware. The chain or wire rope protects the mooring from damage by fishing craft and surface fishing gear. It also adds strength to the upper mooring, which is most affected by the forces of the wind, waves and current.

The nylon rope stretches and recoils in response to forces produced by waves. A swivel, placed between the chain or wire and the sinking nylon rope, responds to the motion of the buoy and prevents twisting of the chain, or wire, and mooring rope.

The catenary curve section forms around the point where the nylon rope and polypropylene rope are spliced together end to end. The offsetting sinking and buoyant properties of the two ropes cause the curve to form.

The sinking property of the nylon rope is used to maintain the catenary curve at a safe depth. Formation of the catenary curve builds scope into the mooring. This extra rope absorbs much of the energy produced by rough seas and thus protects the mooring.

The lower mooring section consists of buoyant polypropylene rope, chain, and connecting hardware. The buoyancy of the rope must be sufficient to lift it and the connecting lower hardware away from the seafloor and so prevent the rope from abrading. Forces exerted on the buoy and mooring by wind, waves and currents near the surface are transferred down the mooring to the chain, which rises and sinks in response. A swivel placed between the polypropylene rope and the chain prevents twists in the chain and mooring rope.

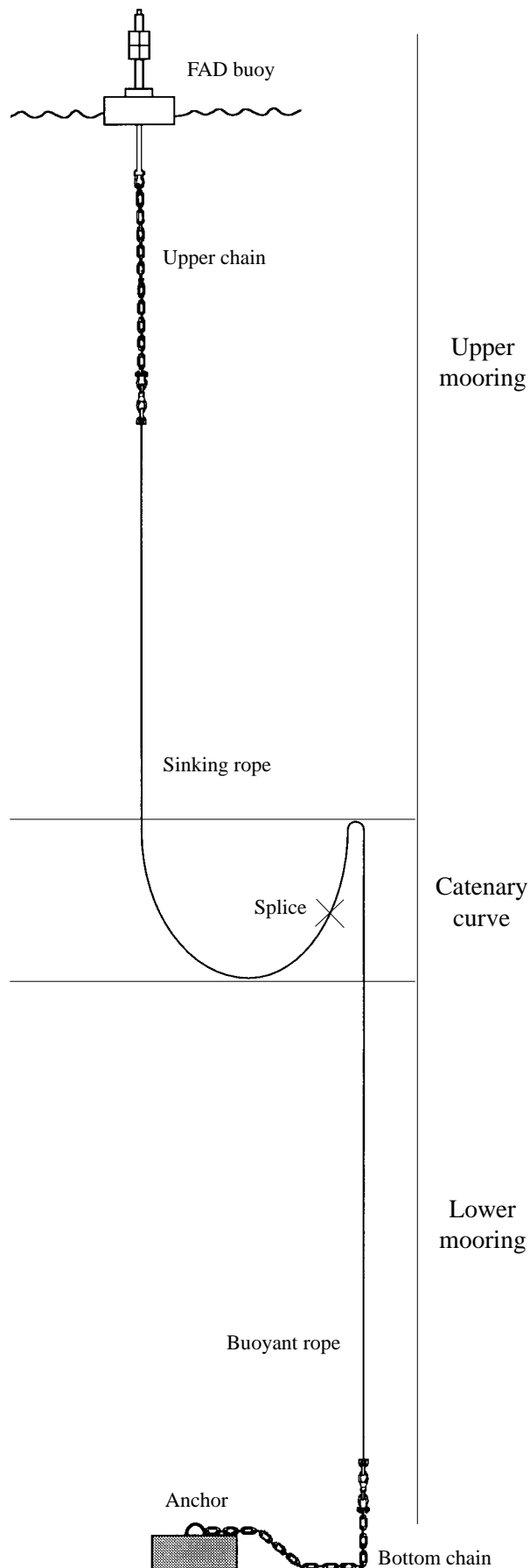

Apart from rigging technique, the lifespan of any FAD depends to a great extent on the quality of the components used to construct it. Ensuring that components are made from suitable materials and that their individual quality is satisfactory will contribute to longer FAD life.

Once a FAD is deployed, it is normally only possible to inspect and maintain the upper 15 m of the mooring, from the buoy to the upper chain/wire-rope connection, or only 1.5 per cent of the total length of a 1,000 m mooring.

This section describes the basic components of any catenary curve mooring and makes general and specific recommendations for components required for the SPC FAD systems.

The basic components of any catenary curve mooring, from the surface to the seabed, are: upper chain or wire, sinking rope (nylon), buoyant rope (polypropylene), bottom chain, and an anchor. Moorings also include connecting hardware, such as safety shackles, swivels and rope connectors, which link the parts of the system.

The specific recommendations given here are based on proven principles of mooring engineering, the known effects of the seawater environment on moorings, and a set of general principles derived through practical mooring experience.

The tables on pages 21 and 23 describe the components for the steel spar buoy and Indian Ocean FAD system respectively.

## GENERAL PRINCIPLES FOR MOORING HARDWARE AND ROPE QUALITIES

### HARDWARE

- Load ratings for all hardware should be equal to or greater than that of the chain used.
- Components should be of the same grade of steel and hot-dip galvanized to prevent corrosion. Do not use components that include different metals.
- To cope with wear and corrosion, heavy-duty components should be used at all points where high wear is likely to occur, including the buoy-mooring and mooring-anchor attachments.







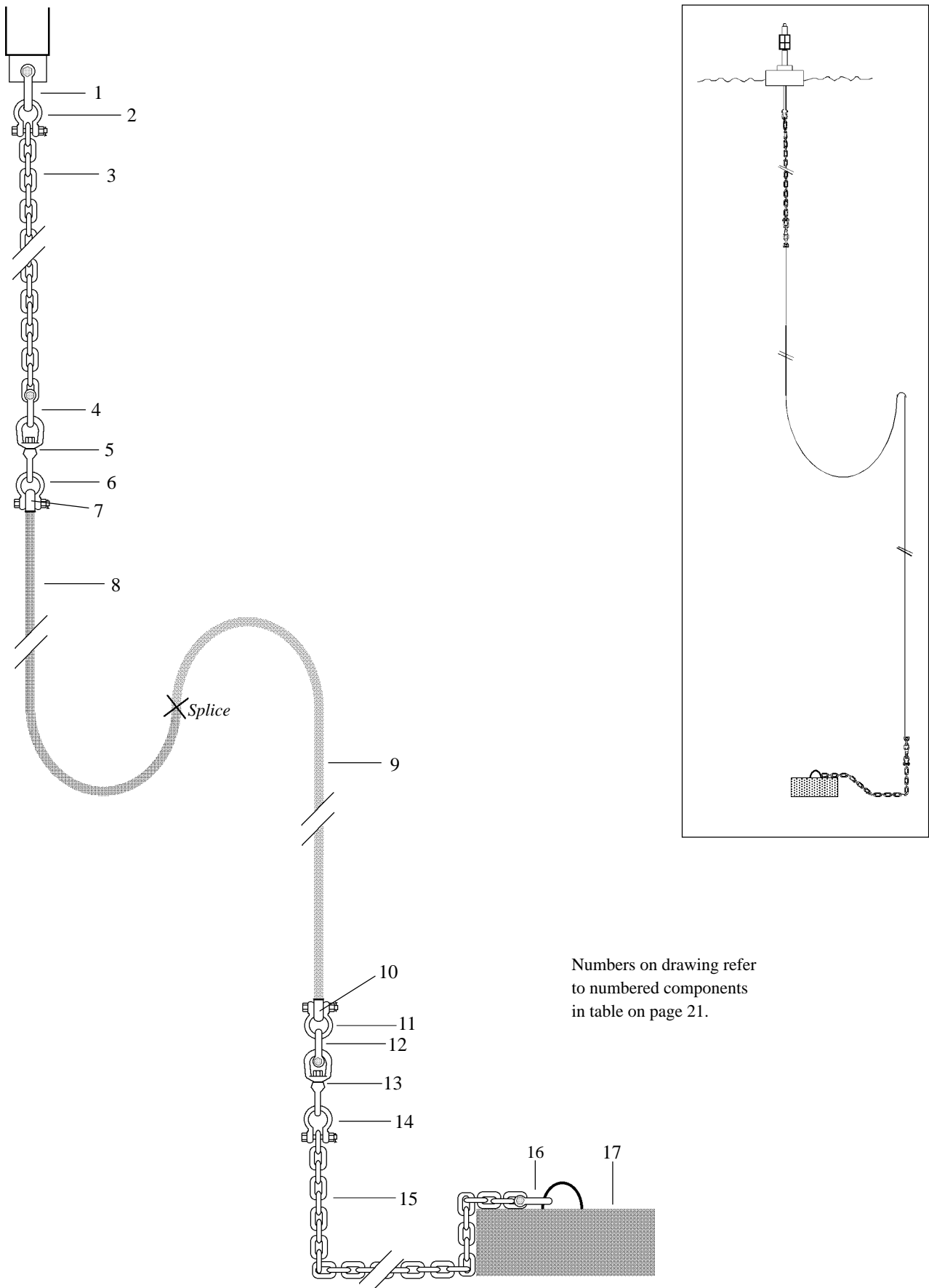









### ROPES

- Moorings should be rigged from plaited ropes (8- or 12-strand). Do not use twisted ropes.

Steel spar buoy FAD system mooring arrangement



Steel spar buoy system components





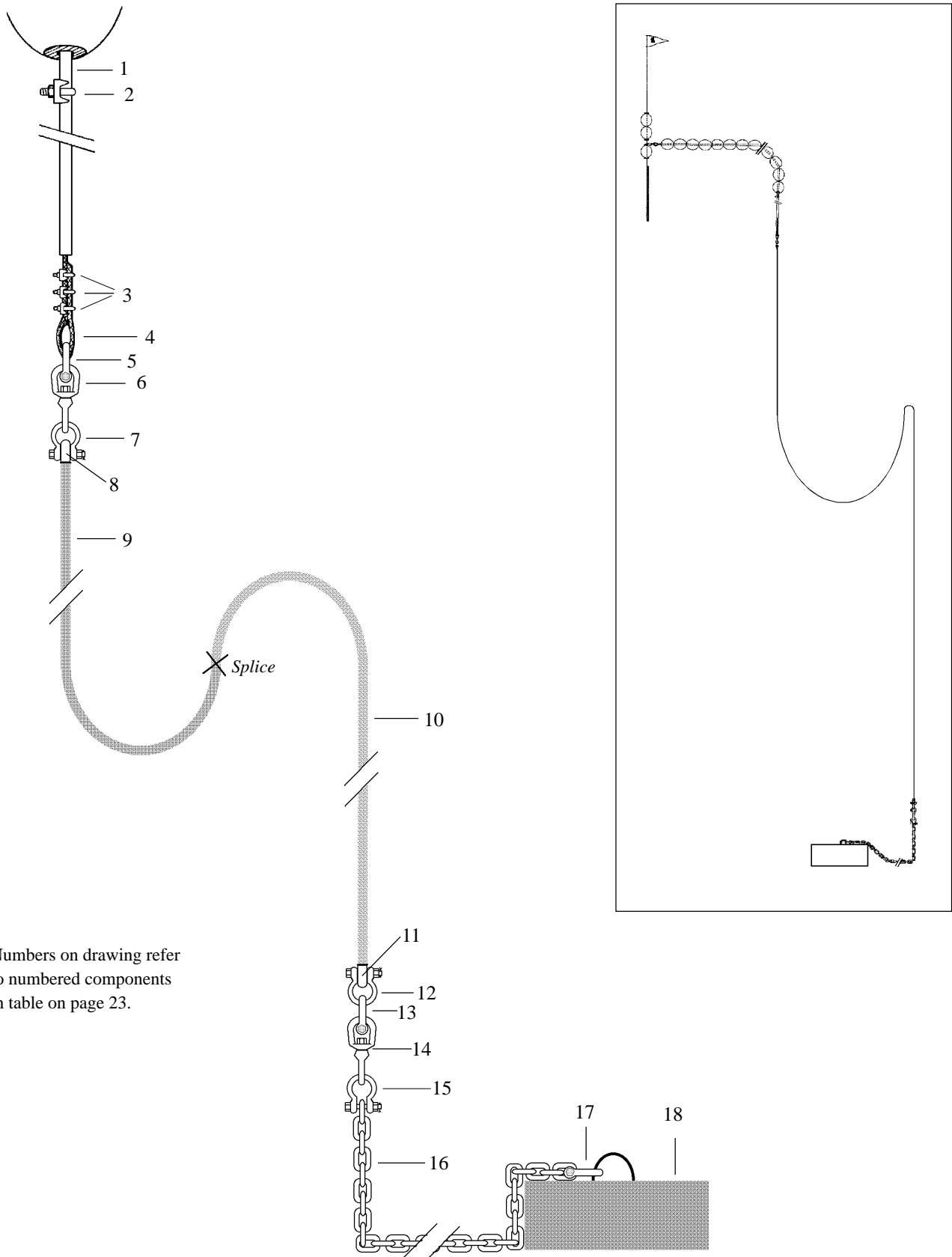













Components		Description	Size	Material	Minimum breaking strength
1		Safety shackle with stainless steel (SS) cotter pin	25 mm 1 in	Hot-dip galvanised low-carbon steel (Hdg-lcs)	25,000 kg 56,000 lb
2		Safety shackle with SS cotter pin	16 mm 5/8 in	Hdg-lcs	10,000 kg 22,000 lb
3		Long-link chain	15 m of 13 mm 50 ft of 1/2 in	Hdg-lcs	9,000 kg 19,000 lb
4		Safety shackle with SS cotter pin	16 mm 5/8 in	Hdg-lcs	10,000 kg 22,000 lb
5		Forged swivel (eye and eye)	22 mm 7/8 in	Hdg-lcs	22,700 kg 50,000 lb
6		Safety shackle with SS cotter pin	22 mm 7/8 in	Hdg-lcs	19,500 kg 49,000 lb
7		Rope connector (Samson; size 3)	19 mm 3/4 in	Nylite	
8		Sinking rope, 8-12 strand, plaited	19 mm 3/4 in 47 kg/220 m 14.3 lb/100 ft	Nylon	6,400 kg 14,200 lb
9		Buoyant rope, 8-12 strand, plaited	22 mm 7/8 in 45 kg/220 m 13.7 lb/100 ft	Polypropylene	5,200 kg 11,500 lb
10		Rope connector (Samson; size 4)	22 mm 7/8 in	Nylite	
11		Safety shackle with SS cotter pin	25 mm 1 in	Hdg-lcs	25,000 kg 56,000 lb
12		Safety shackle with SS cotter pin	19 mm 3/4 in	Hdg-lcs	14,000 kg 31,000 lb
13		Forged swivel (eye and eye)	19 mm 3/4 in	Hdg-lcs	16,200 kg 40,000 lb
14		Safety shackle with SS cotter pin	19 mm 3/4 in	Hdg-lcs	14,000 kg 31,000 lb
15		Long-link chain	15 m of 19 mm 45 ft of 3/4 in	Hdg-lcs	14,000 kg 31,000 lb
16		Safety shackle with SS cotter pin	22 mm 7/8 in	Hdg-lcs	19,500 kg 49,000 lb
17		Anchor	900 kg 2000 lb	Concrete block	Compress. strength 3,000 psi

Indian Ocean FAD system mooring arrangement



Numbers on drawing refer to numbered components in table on page 23.

Indian Ocean FAD system components

Component	Description	Size	Material	Minimum breaking strength
1	 Float cable	30 m of 32 mm 100 ft of 1 1/4 in	Steel wire rope with PVC coating	5,000 kg 11,000 lb
2	 Cable clamp	32 mm 1 1/4 in	Hot-dip galvanised low-carbon steel (Hdg-lcs)	
3	 Cable clamp (6 pieces)	16 mm 5/8 in	Hdg-lcs	
4	 Thimble (2 pieces)	16 mm 5/8 in	Hdg-lcs	
5	 Safety shackle with SS cotter pin	19 mm 3/4 in	Hdg-lcs	14,000 kg 31,000 lb
6	 Forged swivel (eye and eye)	19 mm 3/4 in	Hdg-lcs	16,200 kg 40,000 lb
7	 Safety shackle with SS cotter pin	19 mm 3/4 in	Hdg-lcs	14,000 kg 31,000 lb
8	 Rope connector (Samson: size 3)	19 mm 3/4 in	Nylite	
9	 Sinking rope, 8–12 strand, plaited	19 mm 3/4 in 47 kg/220 m 14.3 lb/100 ft	Nylon	6,400 kg 14,200 lb
10	 Buoyant rope, 8–12 strand, plaited	22 mm 7/8 in 45 kg/220 m 13.7 lb/100 ft	Polypropylene	5,200 kg 11,500 lb
11	 Rope connector (Samson: size 4)	22 mm 7/8 in	Nylite	
12	 Safety shackle with SS cotter pin	25 mm 1 in	Hdg-lcs	25,000 kg 56,000 lb
13	 Safety shackle with SS cotter pin	19 mm 3/4 in	Hdg-lcs	14,000 kg 31,000 lb
14	 Forged swivel (eye and eye)	19 mm 3/4 in	Hdg-lcs	16,200 kg 40,000 lb
15	 Safety shackle with SS cotter pin	19 mm 3/4 in	Hdg-lcs	14,000 kg 31,000 lb
16	 Long-link chain	15 m of 19 mm 45 ft of 3/4 in	Hdg-lcs	14,000 kg 31,000 lb
17	 Safety shackle with SS cotter pin	22 mm 7/8 in	Hdg-lcs	19,500 kg 49,000 lb
18	 Anchor	900 kg 2,000 lb	Concrete block	Compressive strength 3,000 psi

**RECOMMENDED HARDWARE COMPONENTS FOR SPC FAD SYSTEMS**

The preceding figures show the arrangement of the standard components of the two SPC FAD systems. The accompanying tables list the specifications for each recommended component. All of the components specified are widely available, so obtaining the proper components should not present a problem. Substitutions may be made in some circumstances, so long as the replacement component will perform as required.

**Anchor-type safety shackle**

Anchor-type safety shackles are used to make the buoy–chain/wire, chain–rope, and chain–anchor connections. The large bow on this type of shackle makes it easy to connect different-sized hardware, and allows the components to move without binding.

Safety shackles incorporate a bolt secured with a nut and have a cotter pin (split pin) which keeps the nut from coming unscrewed. Shackles are often sold with each part made from a different grade of steel; a bow of mild steel, an alloy steel bolt, and the cotter pin from some other grade of steel. Be specific when ordering shackles. Specify bows and bolt pins of **mild steel**, and **stainless steel cotter pins**. If shackles with alloy bolts are the only ones available, corrosion will occur faster.

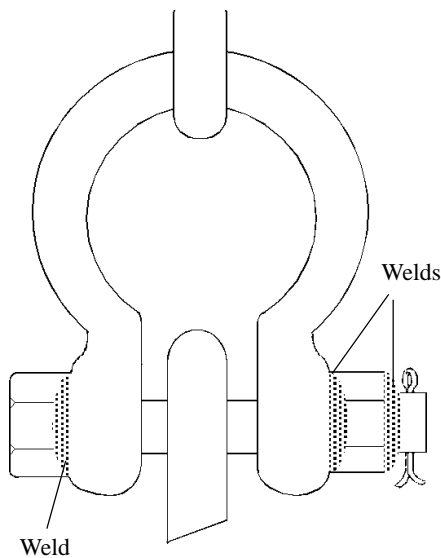
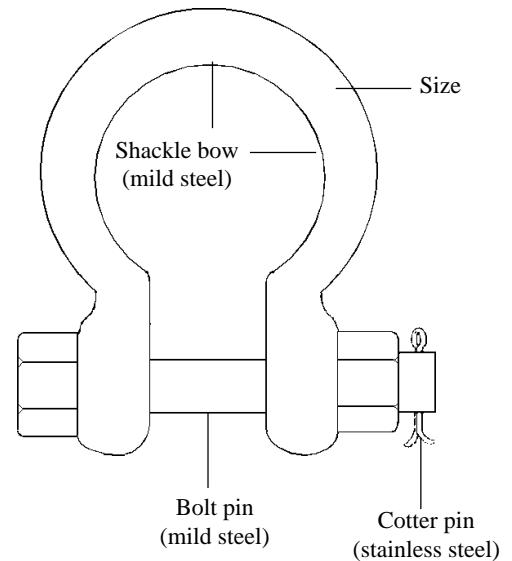

Weld both the bolt and nut to the bow; weld the nut to the bolt pin.

In most cases shackles should be welded closed after the mooring has been rigged. Weld both the bolt and the nut to the shackle bow, and weld the nut to the bolt. Use mild steel rod for the welds, and do not use more voltage than needed to make the welds. High voltage can cause metal fatigue, and could cause the shackle to fail prematurely.

It is usually advisable not to weld the shackles in the upper mooring. If the upper mooring will be inspected and maintained regularly and worn shackles replaced (as is good practice), or if the upper mooring will be periodically replaced, then the shackles should not be welded, but fixed with a stainless steel cotter pin.

The recommended shackles are sufficiently strong and massive to withstand at least two years in seawater.

**Chain**

The SPC steel spar buoy FAD system requires chain in the upper mooring to link the buoy and the upper mooring rope. Both systems require bottom chain to link the lower mooring rope to the anchor.

Hot-dip galvanized, low-carbon steel chain is recommended. Long link or open link type chain is most suitable because the larger link openings allow easier fitting of other hardware.

Chain should also be assessed visually. Good-quality chain has solid, complete, smoothly-dressed welds, and smooth, evenly-rounded corners. Links work smoothly and do not bind.

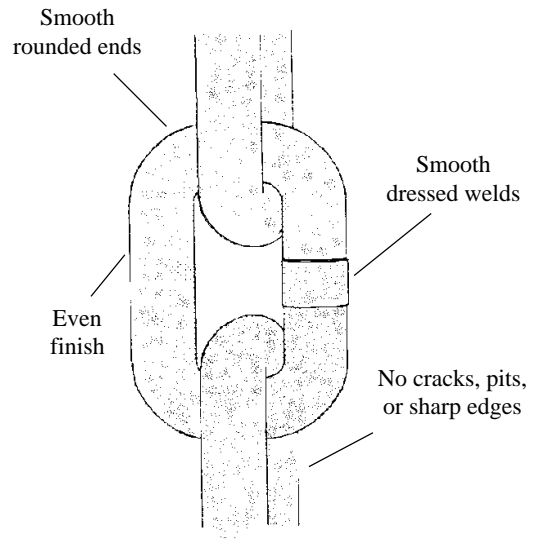

**Good-quality chain**

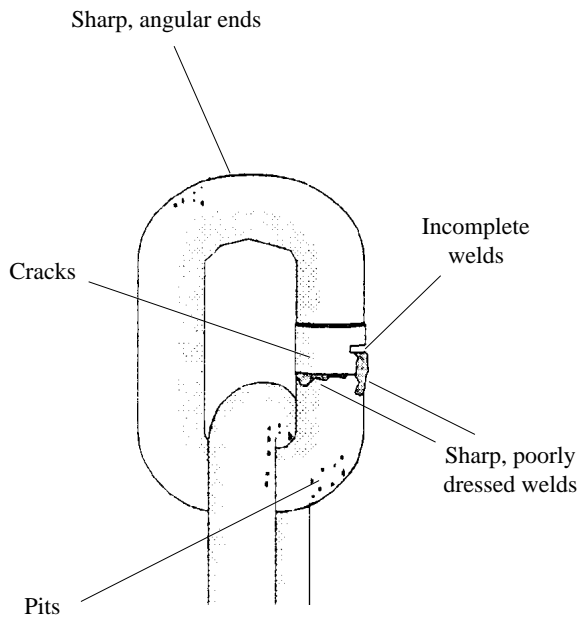

**Poor-quality chain**

**Recognising poor-quality chain**

Welds on poor-quality chain are often incomplete, or may show small fissures or pitting which will quickly give way to stress corrosion or metal fatigue. Welds may not be dressed smoothly, but instead have sharp, jagged edges.

Links in poor-quality chain often have angular inner corners instead of smooth, rounded ones. Instead of working smoothly, the angular corners will cause the links to bind, and create stress points. Such chain will wear unevenly, and over time is more likely to cause breakdown.

Inspect all the welds of any chain carefully before putting the chain into service. A mooring may fail because of just one incomplete weld in a single link of chain.



**Swivels**

Both FAD systems require at least two swivels: one between the upper chain/wire–upper rope connection, and the second between the lower rope–bottom chain connection.

Hot-dip galvanized, forged eye-and-eye swivels made from low-carbon steel are recommended. Look for the same quality indicators as on chain: a complete, smoothly-dressed weld, no jagged edges, and smooth, rounded corners.

Examine the weld on the lifting eye and the connecting bolt and nut. Make sure welds are complete and do not have any cracks or fissures. Test the swivel’s action.

Good-quality swivels spin easily by hand. When constructing the mooring, orient each swivel with the head of the eye-and-eye connecting bolt upward, otherwise the swivels may bind.

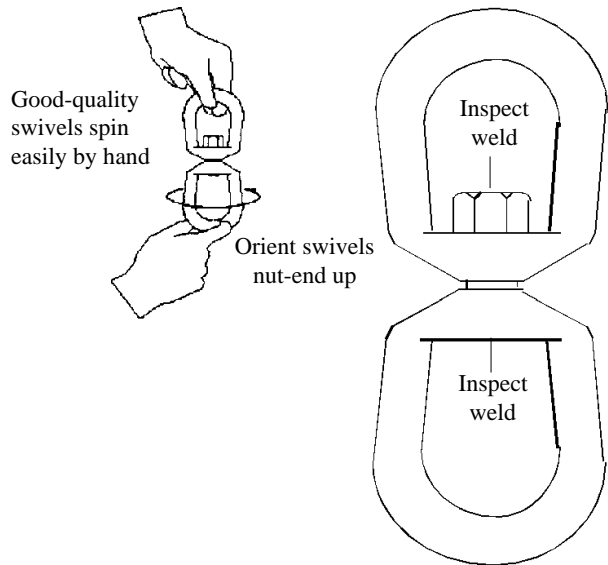

**Forged eye-and-eye swivel**

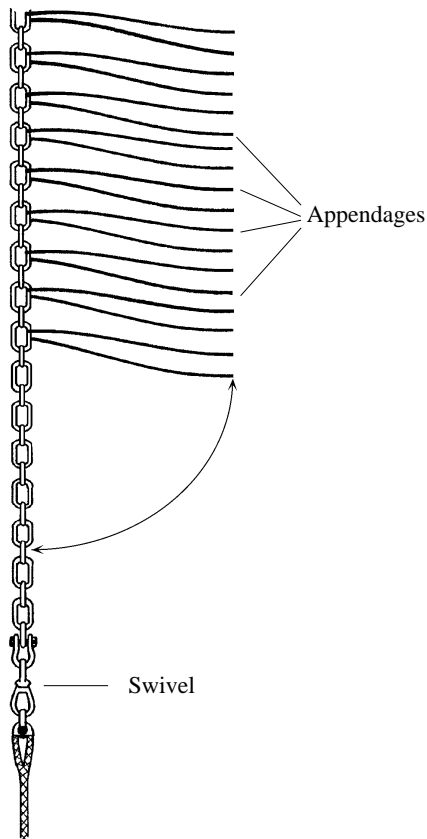

Many fishermen believe that appendages improve a FAD’s ability to aggregate and hold fish. Appendages should be attached to the upper chain or wire section of the mooring.

If appendages are attached to the mooring, measure the distance between the appendages and the swivels carefully. It is important that the distance between the nearest appendage and any swivel be greater than the length of the appendages.

This will prevent appendages from becoming tangled with the swivels. Once tangled, even lightweight appendage material can cause a swivel to bind, and this could lead to the failure of the mooring.

Appendages are discussed in more detail on page 29.

To prevent fouling of the swivel, make sure the appendages can never come close to it.

**Rope connectors**

Rope connectors are used to link the chain/wire and rope sections of the mooring. Rope connectors ensure that the eye-splices formed at the rope ends are secured against working loose. The best connector designs also prevent contact between the steel hardware and the rope, so safeguarding the rope from abrasion.

Modified *Samson Nylite* rope connectors are recommended. *Samson* connectors are easy to fit and provide maximum protection for the rope. They incorporate a self-lubricating centre spool and a urethane rubber protective shield, and are supplied with a chain shackle made of high-test steel. The eye-splice is fitted onto the spool, which is thus inserted in the protective shield and then fitted with the shackle.

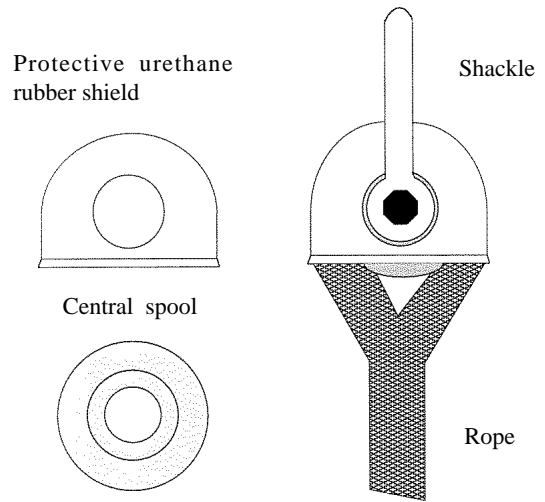

**Samson Nylite rope connector**

It is recommended that the high-test chain shackle supplied with the rope connector **be replaced** with a hot-dip galvanized anchor-type safety shackle made of low-carbon steel. This requires that the hole in the centre spool be drilled out to take the larger-diameter bolt pin of the standard safety shackle. This modification is best done with a drill press.

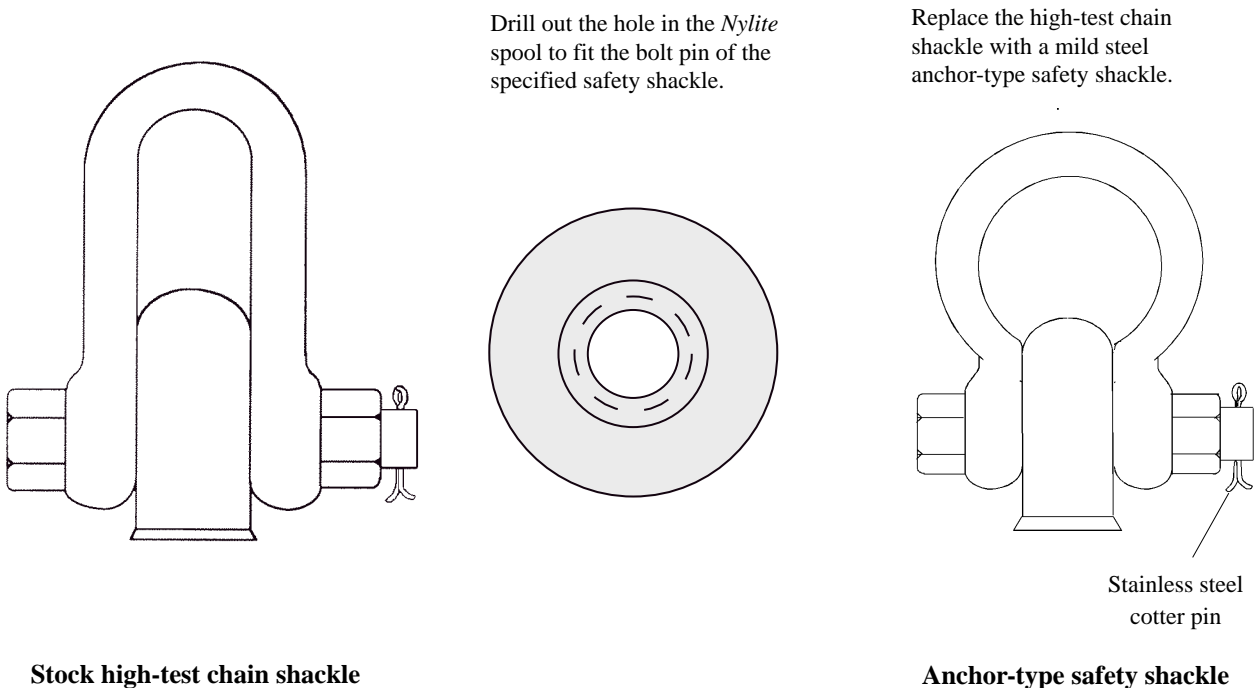

**Stock high-test chain shackle**

**Anchor-type safety shackle**

**Float cable**

The float cable is used to string the purse-seine floats for the Indian Ocean raft. The cable is a 7-strand steel wire rope with a thick coating of PVC bonded to it.

The float cable is both durable and flexible. It fits snugly through the hole in the purse-seine floats. The PVC coating protects the floats from abrasion and is watertight.

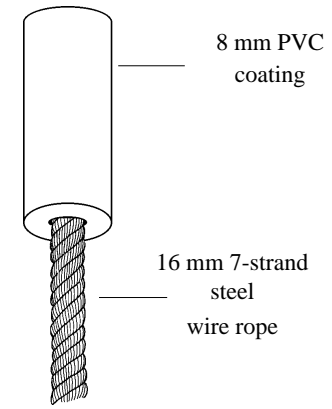

**Float cable**

**Cable clamps**

Cable clamps are used to secure eyes formed in the float cable to attach the mooring rope and flagpole. The clamps ensure that the eyes will not work loose.

Other, larger, cable-clamps are used to hold the purse-seine floats in place on the PVC-coated section of the float cable. If the mast connection eye fails due to corrosion or wear, these clamps will stop the purse seine floats slipping off the end of the wire rope.

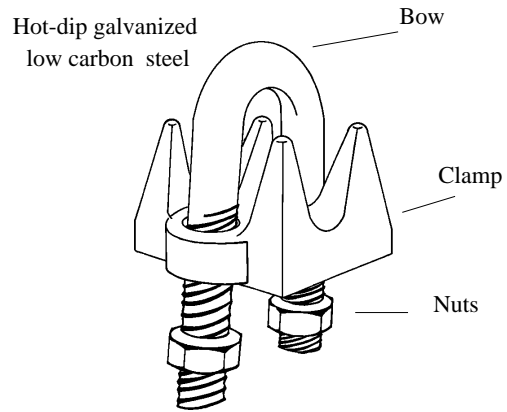

**Cable clamp**

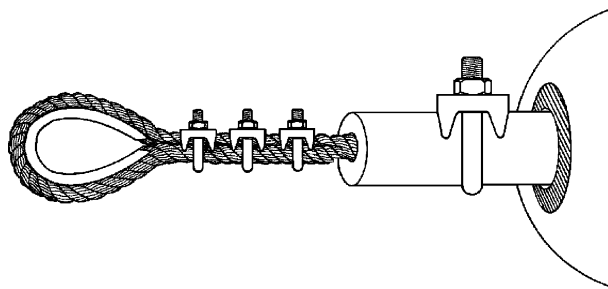

The cable clamp bows must be fitted over the free end of the float cable, as shown here.

Hot-dip galvanized cable clamps made from low-carbon steel are recommended. When making eyes at either end of the wire rope, make sure that all the bows of the clamps are fastened over the free end of the wire rope, as show in the diagram. If the clamps are not fastened properly, the wire rope will bend and the eye will not be straight.

**Thimbles**

The wire rope eyes at either end of the float cable are formed around a thimble. The wire rope runs in the groove of the thimble, which holds it in place. The thimble protects the wire rope from wear.

Hot-dip galvanized thimbles made from low-carbon steel are recommended. The wire rope should fit the thimble groove closely, as under strain a loose thimble may fall out.

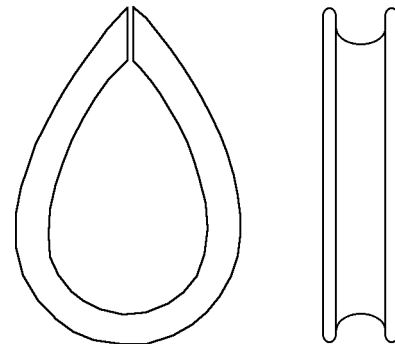

**Thimbles**

## Appendages

It is widely believed that appendages attached below the FAD raft increase the effectiveness of the FAD in aggregating and holding fish. This has yet to be demonstrated by research, but is supported by anecdotal accounts from throughout the Pacific. There are many theories supporting the effective aggregating aspect of appendages. Some believe that appendages provide shelter for prey species which attract larger predators, while others believe that by increasing the underwater profile of the FAD, appendages increase the likelihood that fish will find the FAD and associate with it.

A wide variety of materials and configurations have been used to rig appendages. Coconut fronds, rubber tyres, plastic strapping, old rope and netting have all been used. Plastic strapping, of the type used to bind cartons, has proved to be the most effective material. It is durable, inexpensive, presents minimal drag on the FAD system and is simple to attach to the mooring.

### Steel spar buoy system appendages

For the SPC steel spar buoy FAD system the appendages should be attached to the upper mooring chain. Four-metre lengths of plastic strapping are pulled through and knotted to individual links of chain. Lengths of strapping which are longer than 4 m tend to break off, as the force of the current causes the material to deteriorate. The simplest method for fastening the strapping to the links of chain is to pass the strapping through the gap in the chain link and make an over-hand knot. The strapping should be knotted at the mid-point of the 4 m length so that each of the two free ends is 2 m long.

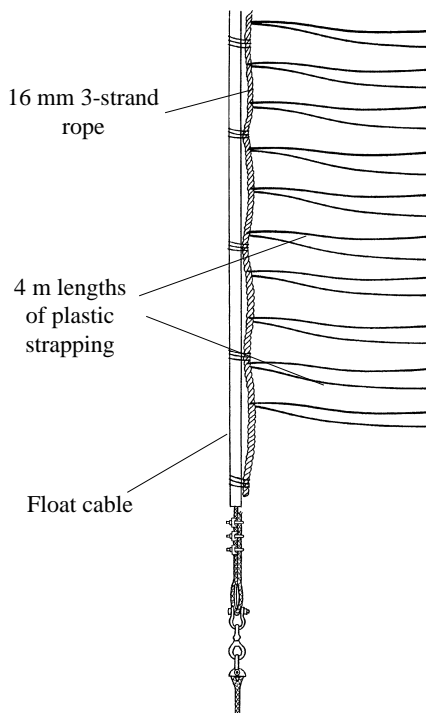
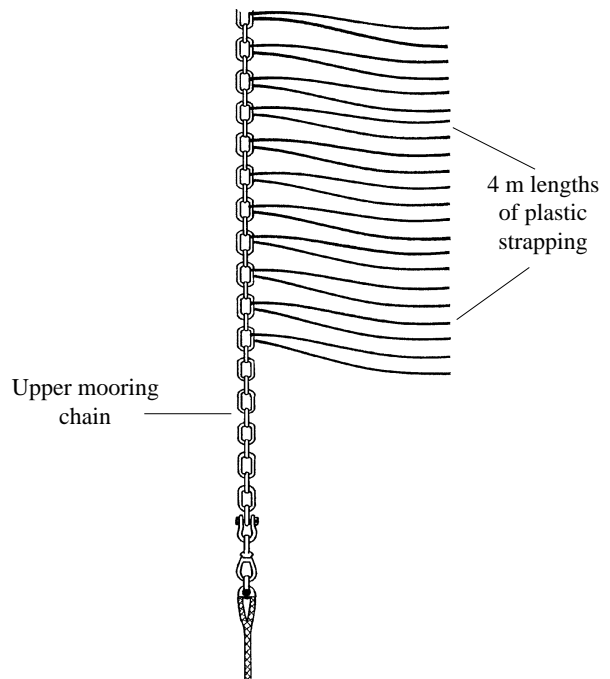

### Indian Ocean FAD system appendages

For the Indian Ocean FAD system, the appendages should be attached to the lower part of the float cable, above where it connects to the upper mooring rope. Four-metre lengths of plastic strapping are pulled through and fastened to a 10 m length of 16 mm 3-strand polypropylene or nylon rope. The method for fastening the strapping to the rope is similar to that used for chain. Twisting the rope in the direction opposite to its lay causes the strands to open; the strapping may then be passed through. An overhand knot is made to hold the strapping in place. The knot is made so that each of the two loose ends is 2 m long. The appendage rope is then whipped onto the float cable at 1 m intervals.

For each method it is important that the distance between the end of the nearest appendage and the swivel be greater than the length of the appendage. This will prevent the appendage from coming in contact with the swivel and possibly interfering with its free movement (see page 26).

**HARDWARE CONNECTIONS**

**Chain–shackle connections**

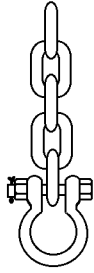

Bolt-pin through the chain link

The use of long-link chain allows the chain–shackle connection to be made either bolt-pin through link or bow through link. The bolt-pin through link connection is recommended.

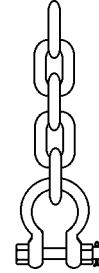

Shackle's bow through the chain link

**Shackle–swivel connection**

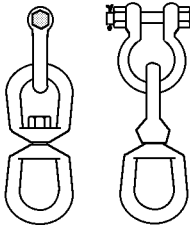

Shackle's bow through swivel's eye

The recommended connection between the shackle and the swivel is the bow to eye connection, but if the bow will not fit through the top eye of the swivel the bolt-pin to eye connection may be used.

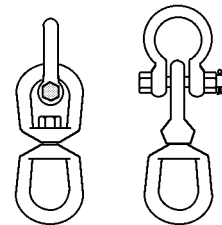

Bolt-pin through swivel's eye

**Swivel–rope connector connections**

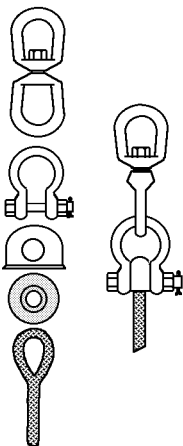

One shackle joins the rope connector and the swivel in the upper mooring.

One shackle joins the rope connector and the swivel in the upper mooring. Two shackles are needed to join the rope connector and the swivel in the lower mooring. The 25 mm shackle required for the No. 4 *Samson Nylite* connector will not fit through the swivel eye, so a 19 mm shackle is required to link these components, as shown.

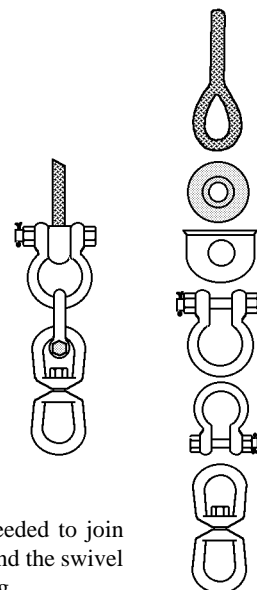

Two shackles are needed to join the rope connector and the swivel in the lower mooring.

## ROPES

Catenary curve moorings are rigged from a combination of sinking and buoyant ropes. The properties of each rope perform specific functions or impart specific features to the mooring. As more than 90 per cent of any deepwater FAD mooring is comprised of rope, consideration of the properties and performance characteristics of rope to be used is very important.

### ROPE RECOMMENDATIONS

The rope recommendations below take account of all the important considerations mentioned above for weight and breaking strength. They must be taken as minimum requirements. Specifications are listed in both metric and U.S. systems of measure.

U.S. rope manufacturers typically list rope weight in terms of either cft or cfm:

- 1 cft = 100 feet (30.5 metres)
- 1 cfm = 100 fathoms (183 metres)

#### ROPE SELECTION CRITERIA

- Material
- Construction
- Size
- Weight
- Breaking strength

UPPER (SINKING) ROPE		
<b>Material</b>	Nylon	
<b>Construction</b>	8–12 strand, plaited	
<b>Measure</b>	<b>Metric</b>	<b>U.S.</b>
<b>Size</b>	19 mm	3/4 in
<b>Weight</b>	21.8 kg/100 m	15.0 lb/cft
	48.0 kg/220 m	90.0 lb/cfr
	0.218 kg/m	0.15 lb/ft
<b>Breaking strength</b>	14,100 kg	14,100 lb

LOWER (BUOYANT) ROPE		
<b>Material</b>	Polypropylene	
<b>Construction</b>	8–12 strand, plaited	
<b>Measure</b>	<b>Metric</b>	<b>U.S.</b>
<b>Size</b>	22 mm	7/8 in
<b>Minimum weight</b>	20.4 kg/100m	14.0 lb/cft
	45.0 kg/220 m	84.0 lb/cfr
	0.204 kg/m	0.14 lb/ft
<b>Breaking strength</b>	11,200 kg	11,500 lb

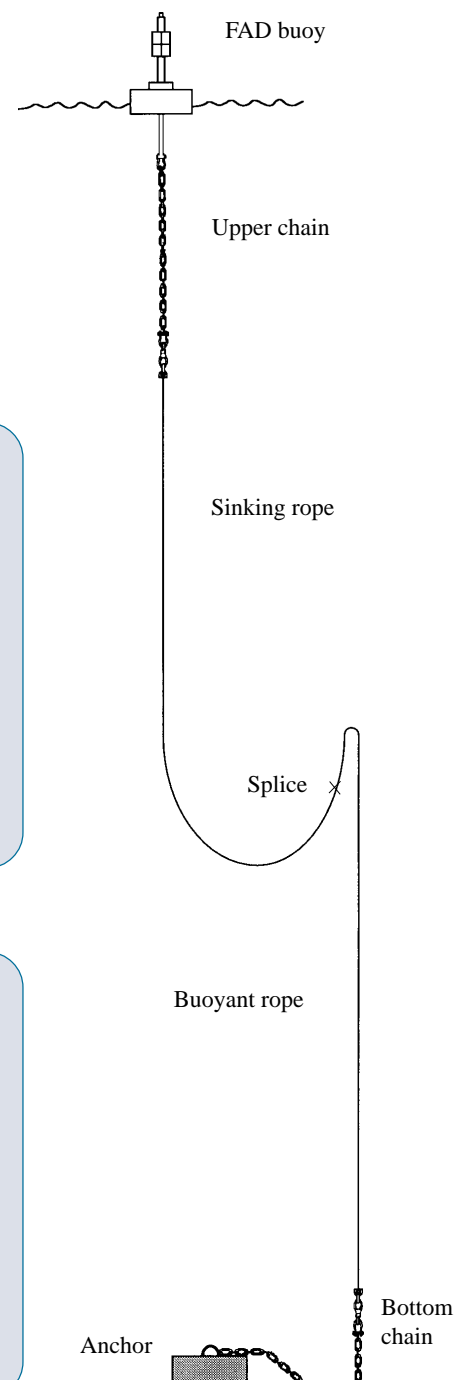

## ROPE MATERIAL

The quality and performance of any rope depends on the material the rope is made from and the way it is manufactured. Important characteristics include specific gravity (whether the material floats or sinks in seawater), breaking strength, strength-to-size ratio, elongation and elasticity, resistance to cyclic and shock loading, abrasion resistance, and durability.

All these properties should be considered when selecting rope, to ensure that the rope will have the

strength to hold FADs on station while presenting minimum drag and will perform according to the needs of the mooring design.

Rigging moorings from ropes made of natural fibres or blended synthetic fibres is not advised. Natural fibres are susceptible to attack by organisms and often rot in seawater.

Blended synthetic fibre ropes are often designed for special purposes and made from materials which have widely different characteristics.

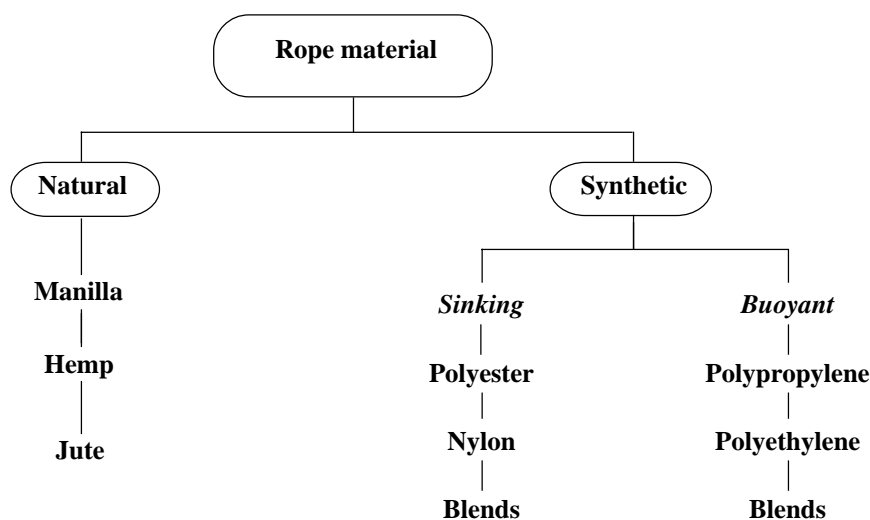

### Nylon

The recommended material for the upper mooring rope is nylon. As the specific gravity of nylon is 1.14, it sinks in seawater. Nylon is one of the strongest, most widely available, synthetic fibre ropes. The breaking strength of nylon decreases slightly when wet, but a 19 mm nylon rope can have a wet breaking strength as great as 8,300 kg.

Nylon is elastic. It will stretch up to 17 per cent of its length under a working load equal to 20 per cent of its ultimate breaking strength. Nylon rope can withstand both the routine cyclic loading (stretch and recoil) caused by ocean swells, and the shock loading (strong, sudden jerks) which will affect a FAD mooring during rough seas and stormy weather.

Nylon is durable. It resists surface wear and internal abrasion caused by flexing and stretching. Nylon also withstands ageing and deteriorates only slightly from exposure to sunlight. Nylon does tend to stiffen somewhat with prolonged immersion in seawater.

### Polypropylene

The recommended material for the lower mooring rope is polypropylene. Having a specific gravity of 0.91, polypropylene floats. Its buoyant property can be used to lift weight. Polypropylene has moderate breaking strength, ranging between 4,200 and 8,200 kg for 22 mm rope. In seawater, the breaking strength of polypropylene actually increases slightly.

Polypropylene has good elastic properties. It can be stretched by about nine per cent of its length and still return to its original length. Polypropylene has excellent shock loading capabilities.

Polypropylene is fairly durable. The single most important exception to its durability is that it does deteriorate with exposure to sunlight. Some manufacturers offer treatments which increase polypropylene's resistance to sunlight.

## ROPE CONSTRUCTION

Different rope constructions can produce dramatically different characteristics—even in ropes that are identical in every other way. The rope constructions most commonly seen in FAD moorings are 3-strand twisted and either 8- or 12-strand plaited. Although 3-strand rope has been widely used for FAD moorings, it is not recommended. Three-strand construction produces characteristics which, even when the utmost care is taken in rigging and deploying FADs, can result in rope failure and premature FAD loss. **The rope construction recommended for deepwater FAD moorings is 8- or 12-strand plaited.**

The next sections describe the similarities and differences between 3-strand twisted and 8- or 12-strand plaited rope constructions.

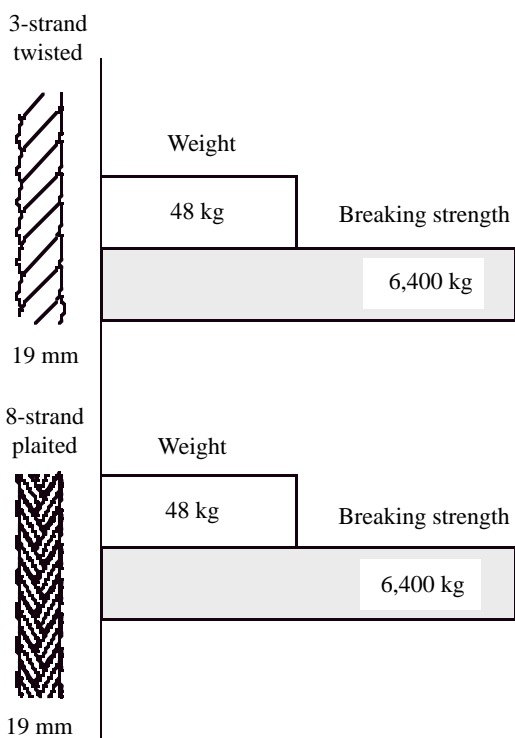

Breaking strength for twisted and plaited ropes of the same size and weight is identical.

3-strand twisted



Do not construct moorings with 3-strand ropes.

8-strand plaited



Construct moorings from 8- or 12-strand plaited ropes.

### Breaking strength

One of the most important properties of a rope is strength. Breaking strength is one property which does not vary between ropes of twisted and plaited construction. Plaited and twisted ropes made from the same material, and of the same size and weight, will have identical breaking strengths.

For example, consider two 19 mm nylon ropes, each weighing 48 kg per 220 m coil. The only difference between the ropes is construction. One rope is 3-strand twisted and the other is 8-strand plaited. The breaking strength of the ropes is identical, at approximately 6,400 kg .

Although construction does not create a difference in breaking strength between 3-strand twisted and plaited ropes, it does produce differences in other rope properties which can affect the lifespan of FAD mooring systems. Three-strand twisted construction has several major disadvantages.



**Twisting, kinking and hockling**

Perhaps the single most undesirable property of twisted rope construction is the tendency for the rope to unlay and form hockles. Whenever 3-strand is twisted against the regular lay of the rope, kinks form as the rope begins to unlay. As the rope unlays further, kinks turn into hockles, which cause permanent damage to the rope. A single hockle can decrease the rope's breaking strength by 30 per cent. Once a hockle forms, no amount of straight pull can remove it from the rope.

Hockles commonly form when force stretches the rope under tension while one end of the rope is free to rotate (a working mooring), or from improper handling of the rope.

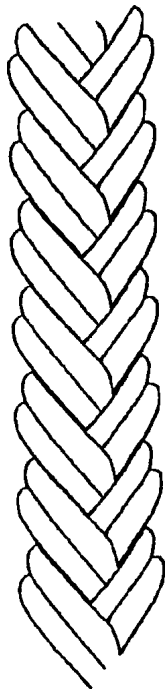

- Strands are interlocked;
- rope cannot unlay and cannot hockle;
- torque-free balance;
- equal numbers of strands run in both directions;
- no built-in tendency for ropes to twist;
- load is evenly distributed;
- proper splices do not form weak points in the rope.

**Advantages of plaited ropes**

**Load distribution and breaking points**

Load is distributed unevenly in 3-strand ropes. At times a single strand may bear most of the load or strain on the mooring, and this may cause rapid deterioration of the rope. In plaited rope construction, load is distributed evenly over all the strands and this prevents premature breakdown of the rope. Splices form a weak point in 3-strand systems. Break tests show that when 3-strand ropes are spliced end-to-end, the splice will give, or the rope will break at the splice, before the main rope breaks. The splice does not form a weak point in plaited ropes. Identical break-tests on plaited ropes have shown that, because load is distributed evenly, the main rope breaks—not the splice.

Once formed, no amount of straight pull will remove a hockle.

A single hockle can decrease rope breaking strength by 30 %.

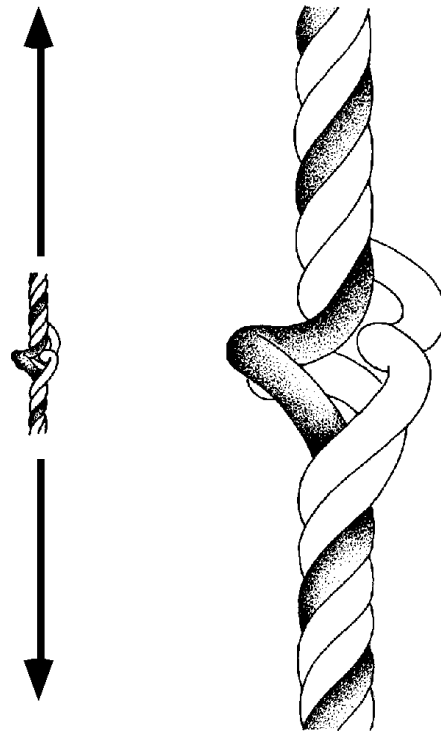

**3-strand twisted ropes can hockle**

**Features of plaited ropes**

Ropes of plaited construction contain an even number of strands, which are often paired. Equal numbers of strands run in opposite directions, and are interlocked. Because strands are interlocked, plaited ropes cannot unlay, and cannot hockle. Because equal numbers of strands run in opposite directions, there is no built-in tendency for plaited ropes to twist. These ropes are said to be **torque-free or torque-balanced**.

Moorings twist and turn continuously during deployment and with the routine sea-keeping motion of the buoy. This action leads to the formation of hockles in 3-strand rope. Consequently, **plaited rope is the only rope construction recommended for moorings**.

## ROPE SIZE AND WEIGHT

Never base selection of ropes of any material on size alone. Always consider size (diameter) and weight together. Rope size can be misleading, because production methods and rope designs differ from one manufacturer to the next. Ropes listed as the same size may contain very different amounts of material. The only sure way to tell exactly how much material (nylon, polypropylene, etc.) the rope contains is by knowing the weight of a standard length of rope. It is the amount, or weight, of material in a standard length of rope that determines certain rope characteristics, such as breaking strength, working load, the cyclic and shock loading forces it can withstand, and, in the case of polypropylene, buoyancy.

The weight of a standard length of rope is the rope's weight:length ratio (kg/m). Weight:length ratios are commonly reported in terms of kilograms per 100 metres (kg/100 m), kilograms per 220 metres coil (kg/220 m), or in U.S. measure as pounds per 100 feet (lb/cft), or pounds per 100 fathoms (lb/cfm; 1 cfm = 600 feet = 183 m).

Breaking strengths differ in same-sized ropes having different weight:length ratios (containing different amounts of material). Heavier rope has greater breaking strength, has a greater workload rating, and can withstand greater shock loads.

The minimum recommended weight for 19 mm nylon mooring rope is 48 kg/220 m coil. (weight:length ratio: 0.218 kg/m)

### Polypropylene material is buoyant

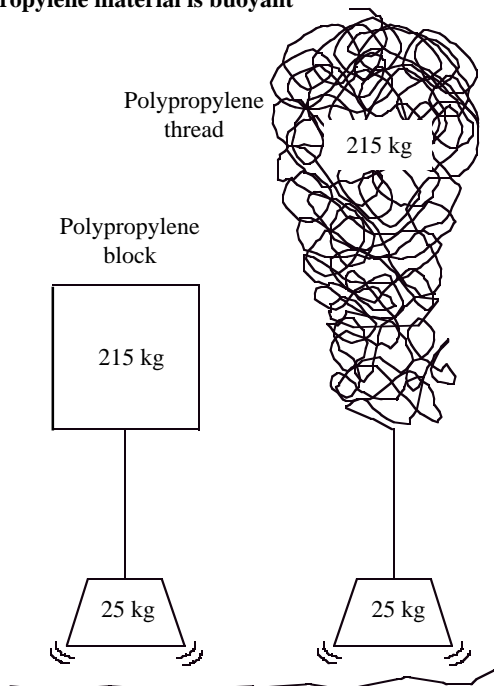

The amount of polypropylene material needed to lift a specific weight does not change, whatever form the polypropylene is in.

### Rope weight and breaking strength

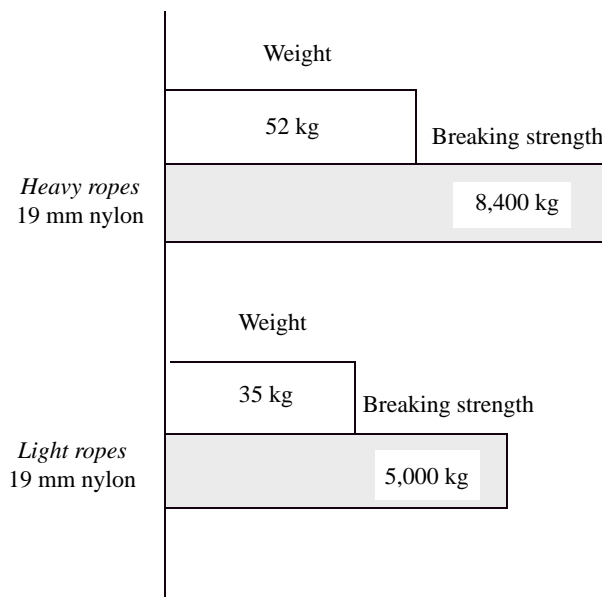

Consider both size and weight when selecting rope. Ropes of the same size can have different weights, and therefore different breaking strengths.

Apart from the strength of the rope, the weight:length ratio of the polypropylene rope has another important function: because polypropylene is buoyant, the heavier the rope, the more hardware it will lift from the bottom.

The amount (weight) of polypropylene material needed to lift a specific weight will never change. In seawater 215 kg of polypropylene material supplies enough buoyancy to lift 25 kg. It does not matter if the 215 kg of polypropylene material is compressed into the smallest block possible, or if it is stretched into a fine thread 1 km long.

The minimum recommended weight for 22 mm polypropylene mooring rope is 45 kg/220 m coil. (weight:length ratio: 0.204 kg/m)

---

## MOORING CALCULATION

### ROPE LENGTHS

The length of buoyant polypropylene rope and sinking nylon rope required to rig an inverse catenary curve mooring for any FAD depend on the site depth, the length of the catenary curve, the weight of the nylon rope, and the buoyancy of the polypropylene rope. Determining what rope lengths must be used to ensure that the mooring maintains the catenary curve at a set depth below the surface and buoys up a section of bottom hardware to keep the lower rope away from the seabed, requires careful calculation.

However, because the weights and weight:length ratios of the components recommended in this manual for rigging a mooring system are known, it is possible to present a calculated table of rope lengths for varying site depths. This is given on page 37. It is important to note that this table of rope lengths should only be used if the hardware components of the FAD are **no heavier than those specified in this manual** and if the weights of the ropes used are **at least as heavy as those specified in this manual**. The rope length table may still be used if the ropes to be used are a little heavier than those recommended, but not if the ropes to be used are lighter.

The table below summarises the specifications of the SPC-recommended components and gives proportions for the overall length and polypropylene sections of a standard inverse catenary curve, as well as the recommended length of lower chain and hardware to be lifted clear of the seabed.

#### SPECIFICATIONS OF COMPONENTS USED FOR ROPE-LENGTH CALCULATIONS

Component	Size	Type	Weight
Nylon rope	19 mm	8- or 12-strand	0.218 kg/m (minimum)
Polypropylene rope	22 mm	8- or 12-strand	0.204 kg/m (minimum)
Shackles	25 mm	Hot-dip galvanized	2.3 kg
	19 mm	Hot-dip galvanized	1.0 kg
Swivel	19 mm	Hot-dip galvanized	1.9 kg
Chain	19 mm	Long-link, coil-proof	8.6 kg/m
Length of catenary curve			Site depth x 25%
Ratio (%) of polypropylene in the catenary curve			25%
Length of bottom hardware/chain to lift			3 m
Total weight of bottom hardware lifted			28.1 kg

ROPE LENGTH TABLE FOR SITE DEPTHS FROM 700–2000 M

Site depth (m)	Length of nylon (m)	Length of polypropylene
* 700	280	595
* 800	300	700
* 900	320	805
* 1,000	335	915
* 1,100	355	1,020
1,200	375	1,125
1,300	395	1,230
1,400	410	1,340
1,500	430	1,445
1,600	450	1,550
1,700	470	1,655
1,800	490	1,760
1,900	505	1,870
2,000	525	1,975

\* FADs set on sites with these depths require supplementary buoyancy (see next paragraph for explanations and calculations )

SUPPLEMENTARY BUOYANCY

The use of pressure-resistant floats

Site depths of less than 1,125 m makes it impossible to use enough polypropylene rope to provide the buoyancy necessary to lift the lower 3 m of chain/hardware clear of the seabed. For these sites, pressure-resistant floats are used to supplement the buoyancy of the polypropylene rope. Floats come in a variety of sizes (buoyancy) and depth ratings. Both of these variables are important for mooring adjustments. The buoyancy of an individual float will determine the number of floats required, while the depth rating will influence the point at which floats are attached to the mooring.

The number of floats required depends on the amount of supplementary buoyancy required and the amount of buoyancy each float can supply. A 1 litre float can lift 1 kg of weight.

For safety, the floats should never be positioned deeper on the mooring rope than half of the depth for which they are rated (0.5 x rated depth). It is recommended that floats with a depth rating of at least 800 m be used for the SPC FAD systems. The floats should also be placed below the lowest point of the catenary curve to avoid any possibility of them entangling this part of the mooring as it moves in changing currents.

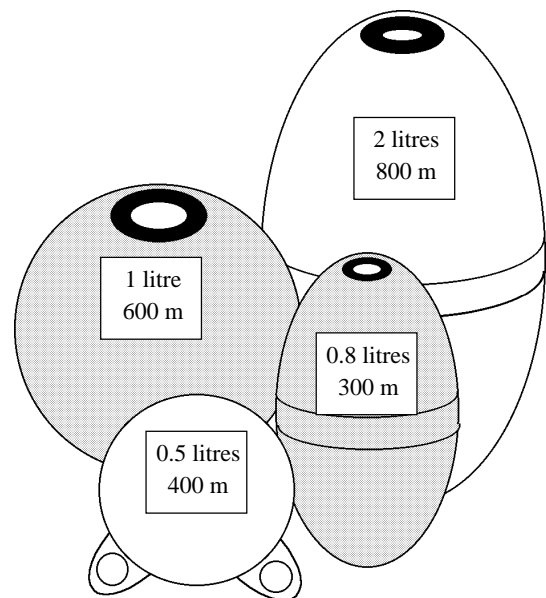

Floats are available in a variety of shapes, sizes and depth ratings.

The table on page 38 lists the supplementary buoyancy required for specific site depths and the point at which the pressure-resistant floats should be attached to the mooring.

**SITE DEPTHS REQUIRING SUPPLEMENTARY BUOYANCY  
AND POSITION FOR BUOY ATTACHMENT**

Site depth (m)	Supplementary buoyancy (l)	Distance of f from seabed
700	11	400–430
800	9	480–510
900	7	570–600
1,000	5	660–690
1,100	3	750–780

**Float attachment**

There are two basic types of pressure-resistant floats: these with a hole through the centre and those with two ears with holes through them.

A 2 m length of polypropylene rope is required to attach each float to the mooring rope.

The diameter of the polypropylene rope should be slightly smaller than the diameter of the hole(s) in the float.

It is simplest to use 3-strand ropes, but plaited ropes can also be used. Three-strand ropes can easily be woven into 8- or 12-strand mooring ropes.

Pressure-resistant floats with a central hole should have an over-hand knot tied at each end of the hole to hold the float in place. Floats with two ears require the 2 m length of rope to be cut into two pieces of equal length.

Each piece is attached with an eye splice to an ear on the float. The free ends of the rope(s) should be unbraided, then woven into the mooring rope. Whip the ends of the float ropes to the mooring rope after they have been woven in.

The ropes should be attached with some slack between the float and the mooring rope. This will lessen the likelihood of friction between the float and the mooring rope.

If multiple floats are required for supplementary buoyancy, position them at least two metres apart along the mooring rope.

**Rigging of centre-hole floats**

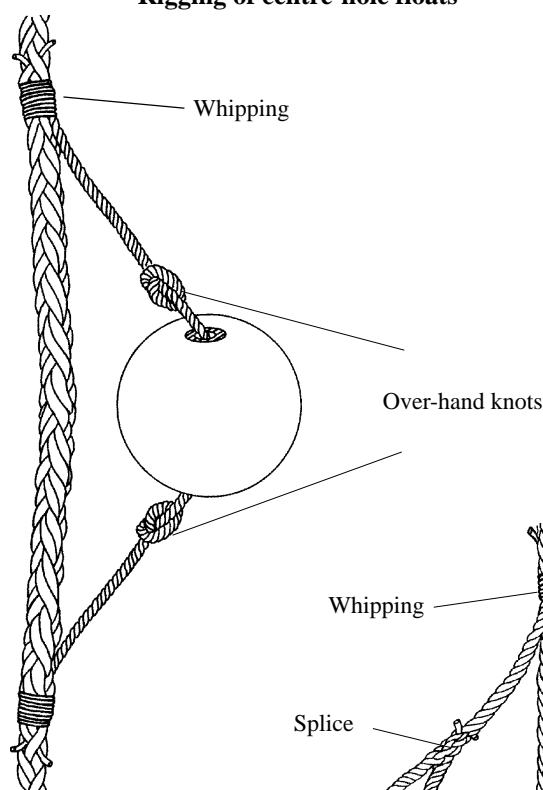

**Rigging of ear-type floats**

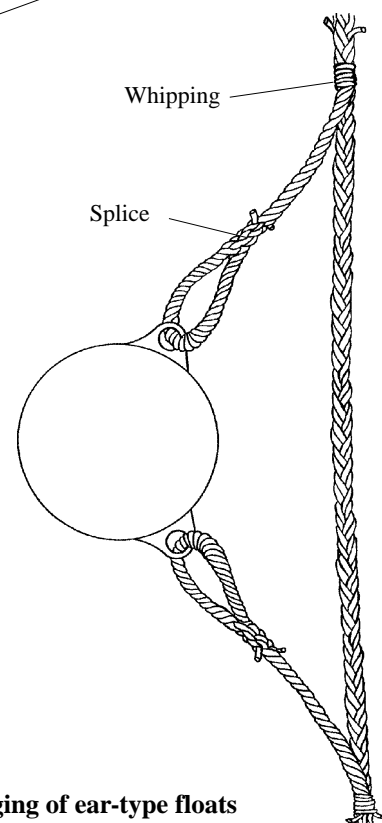

Rigging of ear-type floats

## ANCHORS

### PRINCIPLES FOR ANCHOR CONSTRUCTION

Well-constructed massive anchors are essential for holding FADs on station. Commercial anchors are generally too costly to use for FAD moorings. Suitable anchors can be constructed from surplus steel or concrete. Concrete anchors are recommended for FAD moorings. They are especially well-suited for the rocky bottoms which typically characterise FAD sites in island countries. Cement is widely available and relatively inexpensive. Anchors constructed with care will outlast the life of most FAD moorings.

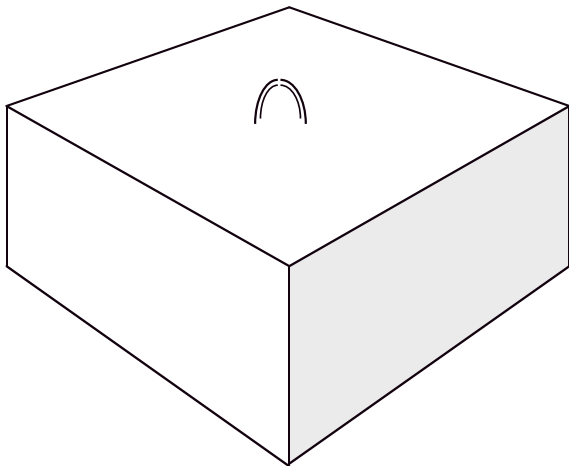

Recommended FAD mooring anchor (square-block-type concrete anchor). Mass: 900 kg (2000 lb).

- The more massive, or heavier, the better.
- Keep the centre of gravity low to prevent tipping or tumbling.
- Make the base broad to resist slippage.

Square, block-shaped concrete anchors with a mass (weight) of 900 kg (2000 lb) are recommended.

The holding power of concrete is 1:2. In other words, a properly-designed concrete anchor can withstand forces up to 50 per cent of its mass, or weight. A 900 kg concrete anchor has a holding power of 450 kg in seawater.

The recommended concrete block anchor resists slippage, because of the friction between the anchor's base and the seabed. The anchor will slip, or become displaced, only when the force exerted on the anchor exceeds the force of friction between the base of the anchor and the seabed. The smaller the area of the base, the less friction between the anchor and the seabed, and the lower the amount of force needed to displace or slip the anchor. The larger the base, the greater the friction, and the greater the force the anchor can resist.

The recommended square-block concrete anchor is designed with the base dimensions greater than the anchor's height. The anchor is designed to have a low centre of gravity which helps prevent it from tipping or tumbling down sloping seabeds.

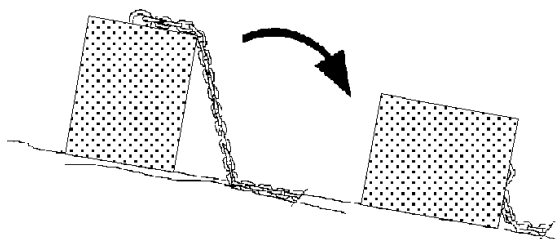

Anchors with high centres of gravity are prone to tipping and tumbling.

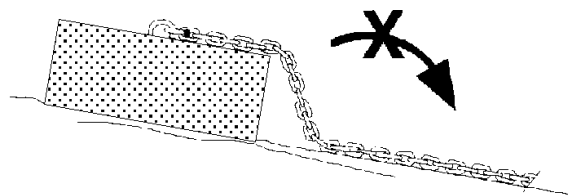

Anchors with low centres of gravity are less likely to tip or tumble.

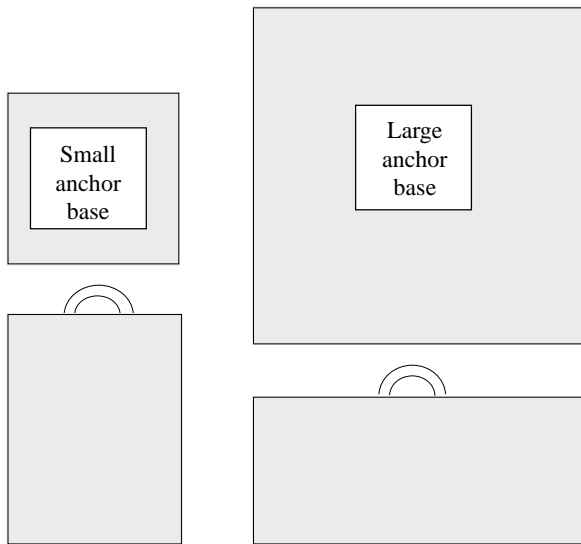

- Small base means: small contact area, low friction, anchor can easily slip.
- Large base means: large contact area, high friction, anchor will resist slipping.

Always construct anchors with a proper steel bail, or connecting point. Connect the anchor to the mooring's bottom chain with a safety shackle.

**Bail**

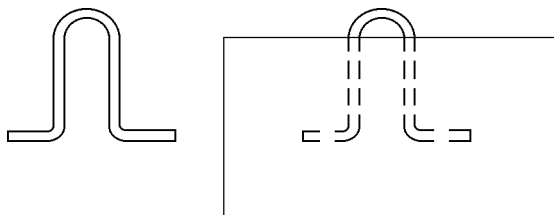

Always equip anchors with a proper bail.

Never embed the end of the bottom chain in the concrete. The mooring bottom chain moves in response to sea conditions near the surface. The chain's motion will erode the concrete where the chain enters the anchor. As erosion proceeds with time, a cleavage plane forms a weak area where the anchor may

crack. The anchor will eventually break at stress levels less than those it was designed to withstand.

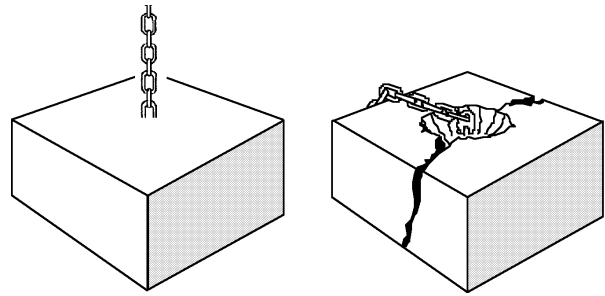

Never embed the bottom chain in the anchor. The movement of the chain may erode the concrete and cause the anchor to break.

The two essentials for making high-quality concrete anchors are the correct mix (of cement, sand, and water), and proper curing of the concrete. Unsuitable mixes and improper curing are probably two of the most common reasons for anchor failure. A proper mix ratio and correct curing will produce an anchor that is impermeable to seawater.

Concrete requires 28 days of moist curing to attain its maximum strength. Moist curing requires that the concrete be kept constantly damp. This is best done by covering the block with sacking and having water trickle onto it through a hose. A complete 28-day cycle of moist curing will produce the strongest concrete possible.

**Concrete strength**

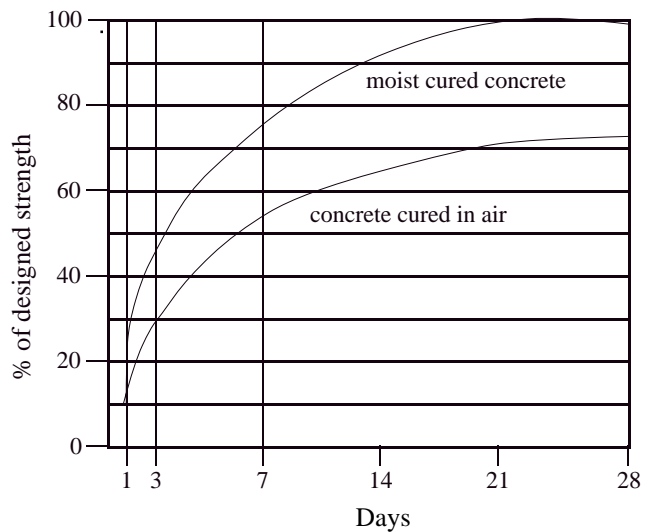

## CONSTRUCTION OF CONCRETE ANCHOR

### Anchor attachment point (bail)

Construct the anchor bail from a single piece of smooth, low-carbon steel roundstock, bent as shown. Make the 'wings' on either end of the bail 5 times as long as the diameter of the roundstock. For example, for a bail made from 32 mm roundstock, the wings should be at least 15.5 cm. If smooth roundstock is not available, concrete reinforcing bar will do. Make sure that the bail is positioned in the block so that the bow of the connecting shackle will fit through it.

### Reinforcing concrete anchors

Reinforcing the anchor will strengthen the concrete against cracking, both on impact during deployment, and while in service. Reinforcing consists of a rebar cage constructed from Size 4 (10 mm) rebar. Wire or tack-weld the rebar together so that the cage forms a single unit. No bar should be closer than 7.5 cm to any external surface. The 7.5 cm cover of concrete forms a barrier and protects the steel from corrosion caused by seawater. The spacing of the rebar should not exceed 25 cm or be less than 18 cm.

#### 3/4 view

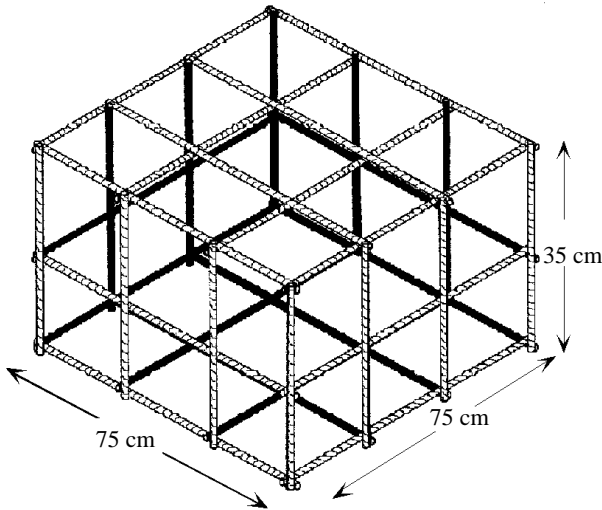

#### Side view

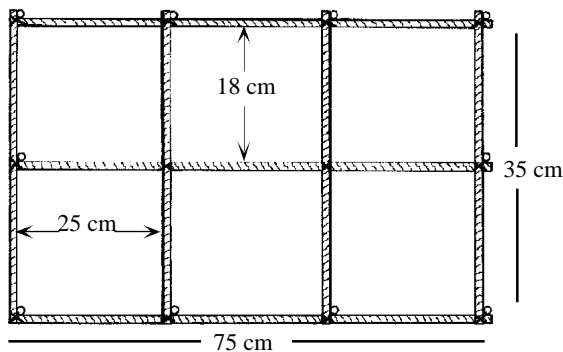

### Bail

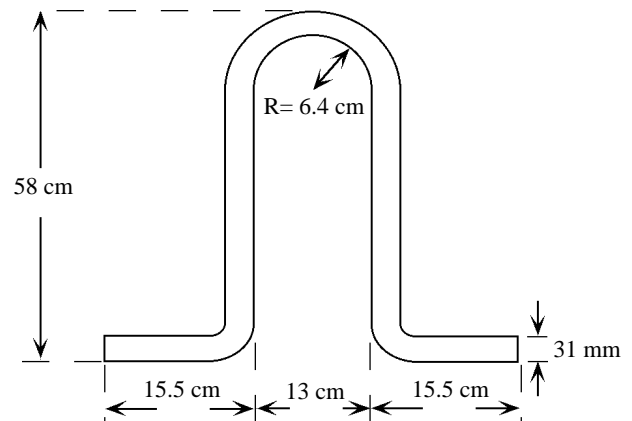

Total length of roundstock: approx. 163 cm

### Forms

Use plywood and solid timber to construct wooden forms for pouring the anchors. Build several forms, because pouring several anchors at once is more efficient and makes it easier to maintain quality standards. The forms should be strong enough to maintain the anchor's shape and to prevent leakage of wet cement. They should also be easy to remove without prying on the anchor, and should be designed so that they can be disassembled and stored for later use. The inside measurement of the form should be 7.5 cm larger than the outside diameter of the rebar reinforcing cage.

### Form for anchor block

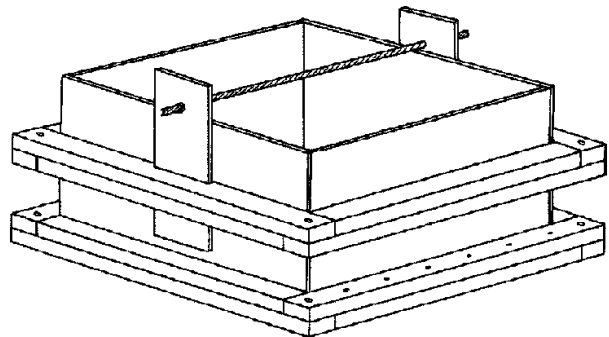

Form for 91 cm x 91 cm x 50 cm concrete anchor block



**Mixing concrete**

General-purpose cement (Type 1 Portland Standard) is the most widely available, and is the type most often used for making self-mixed concrete. Select good-quality aggregate, because sand and gravel (or crushed stones) comprise 65–75 per cent of concrete. Concrete is strongest and most dense when aggregate materials (sand and gravel) contain particles of varying sizes. For concrete anchors, the recommended maximum size of the coarse aggregate is 20 mm. Avoid using crushed coral or crumbly rock as aggregate. Coral is porous; it traps air and will break easily. Crumbly rock will break up under minimal pressure. Whenever possible, avoid using coral sand as it is porous and weak. River sand is good for fine aggregate. Check that the aggregate is clean and free of contaminants, especially silt and organic matter which can prevent the concrete from bonding. Wash the aggregate repeatedly with fresh water if it appears dirty.

The standard weight of a cement bag is 50 kg. To make a large batch of concrete, use a bag of cement as a measuring standard. Find a bucket large enough to hold the entire bag of cement. Jiggle the bucket so the cement forms a level surface and then mark the bucket. The bucket can then be used to measure all the other dry materials. The following table gives measures of materials for a 900 kg concrete anchor:

**MATERIALS REQUIRED FOR 900 KG CONCRETE ANCHOR**

**Cement**

No. of 50 kg bags 4

**Sand**

No. of 50 kg bags 6

**Stone**

No. of 50 kg bags 8  
max. size: 20 mm

**Water**

23 litres per bag of cement 92 litres

---

## CONVERSION TABLES

### Mass (weight)

1 kilogram (kg) = 2.205 pounds (lb)

### Volume

1 litre (l) = 0.275 U.S. gallon

### Pressure

1 pound per square inch (psi) = 0.0703 kilogram per square centimetre (kg/cm<sup>2</sup>)

### Length

1 millimetre (mm) = 0.039 inch (in)

1 centimetre (cm) = 0.393 inch (in)

1 metre (m) = 3.281 feet (ft)

**Manufacturers often use nominal equivalents in converting metric to U.S. standard measure. Please note the following conversions used in this manual:**

5 mm	=	3/16 in	16 mm	=	5/8 in
6 mm	=	1/4 in	19 mm	=	3/4 in
8 mm	=	5/16 in	22 mm	=	7/8 in
10 mm	=	3/8 in	25 mm	=	1 in
12 mm	=	1/2 in	50 mm	=	2 in
14 mm	=	9/16 in	100 mm	=	4 in

