

NAUTICAL KNOWLEDGE

FOR PACIFIC ISLAND MARINERS

**RESTRICTED CLASS 6 - MASTER/ENGINEER
SPC O21B**

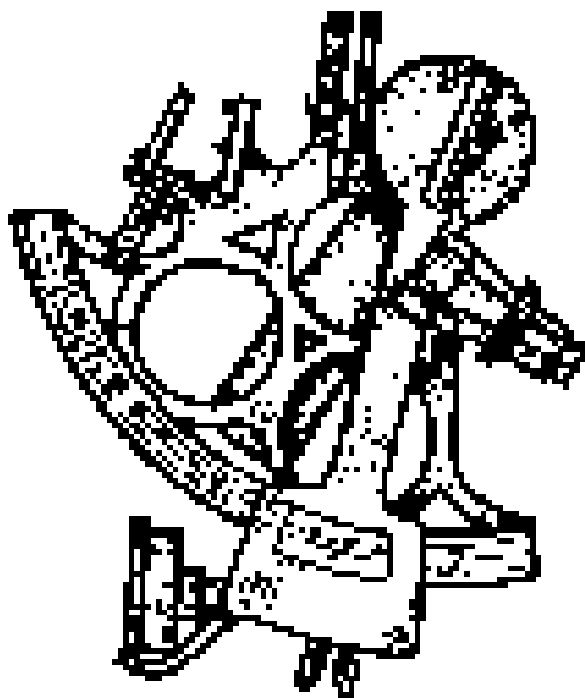

LEARNER'S GUIDE



SECRETARIAT OF THE PACIFIC COMMUNITY



GOVERNMENT OF TAIWAN/ROC

TABLE OF CONTENTS

GENERAL INFORMATION.....	5
1. INTRODUCTION.....	5
2. PROGRAMME DEVELOPMENT.....	5
COURSE INFORMATION.....	6
1. MODULE NAME.....	6
2. PREREQUISITES.....	6
3. COURSE DURATION.....	6
4. ASSESSMENT.....	6
5. RPL.....	6
6. RESOURCES.....	6
SECTION 1 VESSEL MANOEUVRING & HANDLING	7
1. MANOEUVRING CHARACTERISTICS.....	8
2. EXTERNAL CONDITIONS.....	15
2.1 TIDES AND CURRENTS.....	15
2.2 HEAVY WEATHER.....	16
2.3 MANOEUVRING AROUND LARGE VESSELS.....	19
3. ANCHORING.....	21
3.1 PREPARATION.....	21
3.2 LETTING-GO ANCHOR.....	21
3.3 WEIGHING ANCHOR.....	23
4. BERTHING & UNBERTHING.....	24
4.1 BERTHING A SINGLE SCREW VESSEL.....	24
4.2 BERTHING A TWIN SCREW VESSEL.....	26
4.3 ALLOWANCES FOR WIND.....	27
4.4 UNBERTHING.....	27
4.5 UNBERTHING IN AN ONSHORE WIND.....	28
5. TOWING OPERATIONS.....	29
SECTION 2 EMERGENCY PROCEDURES	31
1. MARINE CASUALTIES.....	32
1.1 COLLISIONS.....	32
1.2 GROUNDINGS.....	34
2. DISABLED VESSEL.....	36
3. PERSON OVERBOARD.....	37
4. DISTRESS PROCEDURE.....	37
5. STABILITY.....	38
5.1 FREEBOARD.....	38
5.2 CENTRE OF GRAVITY.....	40
5.3 FREE SURFACE EFFECT.....	41
5.4 CAPSIZING.....	42
SECTION 3 MARINE LEGISLATION PROCEDURES	43
1. CERTIFICATE REQUIREMENTS.....	44
2. POLLUTION PREVENTION.....	44
2.1 DISCHARGE OF OIL.....	45
2.2 DISPOSAL OF GARBAGE.....	45

SECTION 4 WEATHER WATCHKEEPING PROCEDURES**47**

1.	COMMON TERMS	49
2.	WEATHER REPORTS	50
3.	INTERPRETING WEATHER REPORTS	51
3.1	THE SYNOPTIC CHART	51
3.2	USEFUL METEOROLOGICAL INSTRUMENTS	51
4.	TROPICAL REVOLVING STORMS	52
4.1	DEVELOPMENT OF THE TROPICAL REVOLVING STORM	52
4.2	MOVEMENT OF A TROPICAL REVOLVING STORM	53
4.3	PARTS OF A TROPICAL REVOLVING STORM	54
4.4	ACTION TO TAKE WHEN NAVIGATING NEAR A TROPICAL REVOLVING STORM ...	55
4.5	WARNING SIGNS OF BAD WEATHER	55

SECTION 5 WATCHKEEPING**56**

1.	THE COLREGS	57
1.1	APPLICATION OF THE COLREGS	57
1.2	COLREGS PART B - STEERING AND SAILING RULES	58
1.3	COLREGS PART C - LIGHTS AND SHAPES	61
1.4	ANNEX 4 : DISTRESS SIGNALS	62

SECTION 6 VESSEL CONSTRUCTION**64**

1.	DESIGN FEATURES	65
1.1	HULL	65
2.	CONSTRUCTION MATERIALS	68
2.1	ALUMINIUM	68
2.2	STEEL	68
2.3	TIMBER	69
2.4	FIBRE REINFORCED PLASTIC	69
2.5	FERRO CEMENT	70
3.	WATERTIGHT INTEGRITY	71
3.1	MAINTENANCE OF WATERTIGHT INTEGRITY	73
3.2	SAFETY PROCEDURES FOR MAINTAINING WATERTIGHT INTEGRITY	74

SECTION 7 ROPEWORK**75**

1.	FIBRE ROPE	76
1.1	SYNTHETIC FIBRE ROPES	76
1.2	FIBRE ROPE LAY	77
1.3	FIBRE ROPE SIZE	78
1.4	FIBRE ROPE STRENGTH	78
2.	FIBRE ROPE DAMAGE	80
3.	MAINTENANCE AND CARE OF FIBRE ROPES	81
4.	SAFE USE OF FIBRE ROPES	82
5.	KNOT WORK	83
5.1	IMPORTANT TERMS	84
5.2	KNOTS, BENDS AND HITCHES	85
6.	EYE SPLICE	90

1.	NAVIGATIONAL CHARTS	94
1.1	INFORMATION ABOUT THE CHARTS	94
1.2	INFORMATION ON CHARTS	97
1.3	DEPTH CONTOURS	97
2.	DISTANCES	98
2.1	MEASURING DISTANCES ON CHARTS	98
2.2	SPEED, TIME & DISTANCE	99
3.	COURSE AND BEARING	100
4.	NAVIGATING SMALL CRAFT	103
4.1	LEADING MARKS & TRANSITS	103
4.2	BEAM BEARINGS	104
5.	TIDES	105
6.	STEERING & OBTAINING BEARINGS	108

GENERAL INFORMATION

1. Introduction

The Nautical Knowledge module (SPC 021B) of the Restricted Class 6 Master/Engineer certificate has been designed and is intended for the skippers of small boats (less than 15 meters in length) operating in near coastal waters. The content of the module has been modeled on the Nautical Knowledge module (SPC 021) of the Class 6 Master/Engineer course developed by the Regional Maritime Programme of Secretariat of the Pacific Community. It has been modified to meet the requirements of skippers of the smaller boats in Pacific Island countries and territories.

This Learner's Guide is designed for students who are being trained and assessed on the Nautical Knowledge module (SPC 022C), as part of a Restricted Class 6 Master/Engineer course. Attendance at the module sessions and studying of the Learner's Guide should be sufficient for having the proper knowledge required for the safe operation of a small vessel.

2. Programme development

The resource materials were produced with financial support from the Government of Taiwan/ROC and compiled by Grant Carnie, Manager of Fishing & Maritime Programmes, Australian Fisheries Academy, Adelaide, South Australia.

The materials were developed through consultation with staff of the Fisheries Training Section, Coastal Fisheries Programme, Secretariat of the Pacific Community and regional experts on fishing and maritime training. Resources from Australia and New Zealand, SPC training materials and valuable resource material such as the *Australian Boating Manual* by Captain Dick Gandy were used as a guideline in developing materials that were relevant to small-boat operators in the Pacific Island region.

COURSE INFORMATION

1. Module name

Nautical Knowledge SPC 021B.

2. Prerequisites

A Safety certificate and some sea time are the prerequisites for the Class 6 Master/Engineer certificate (Full or Restricted). Refer to local regulations for any specific country requirements.

3. Course duration

Two weeks (at the discretion of the course provider).

4. Assessment

Candidates doing the Nautical Knowledge module will be assessed as they are completing the competencies.

5. Recognition of Prior Learning (RPL)

If students have been assessed previously for some of the learning outcomes or believe that they are competent in certain areas, they can apply to the trainer/assessor to have these particular skills recognised.

6. Resources

The resources required by anyone attending the Nautical Knowledge module are minimal. An in-depth study of this Learner's Guide and attendance at all sessions of the training should be sufficient for a candidate to successfully complete the module. Candidates should check with the training institution offering the course with regards to clothing requirements for the practical components.

Anyone wanting additional resource materials could borrow or purchase a copy of *The Australian Boating Manual* by Captain Dick Gandy or *Safety in Small Craft* by Mike Scanlan or "FAD Fishing Skills Workshops SPC Module 2, "Safety at Sea and Small Boat FAD Fishing".

Section 1

Vessel Manoeuvring & Handling

1. MANOEUVRING CHARACTERISTICS

Vessels all behave differently due to a variety of factors, including:

- type of hull
- draft in relation to 'sail-area'
- type & efficiency of the rudder(s)
- type & efficiency of propulsion

Let us examine two basic hull forms for smaller craft, the *displacement* type and the *planing* type.

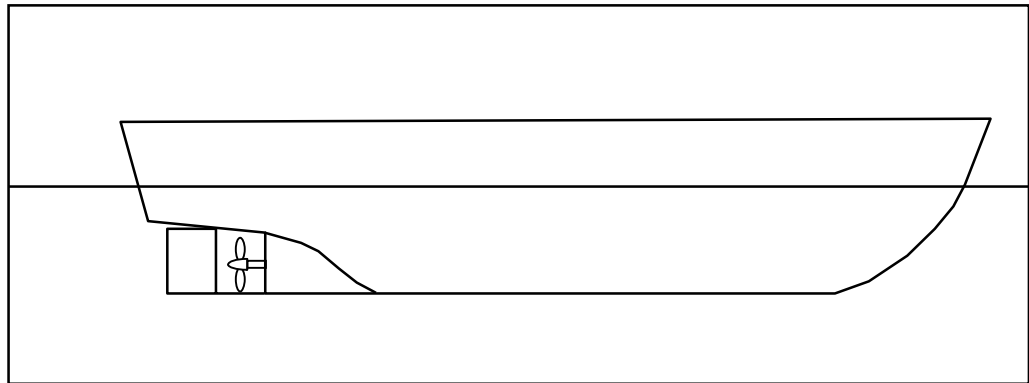

Figure 1.1 Displacement Hull

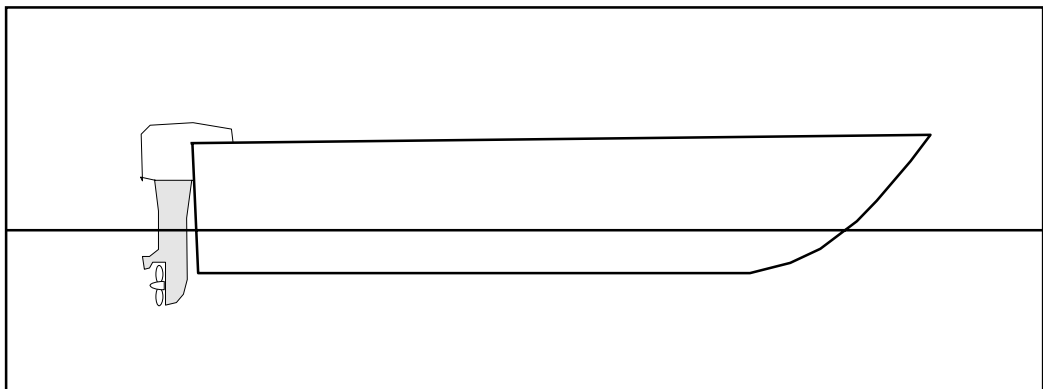

Figure 1.2 Planing Hull

<i>Displacement Hull</i>	<i>Planing Hull</i>
Designed to be continually submerged at all speeds. Examples: Tugboats, Trawlers, etc.	Designed to skim across the water upon reaching high speeds. Examples: Speed boats, high speed naval craft and catamarans, etc.
Heels outward when turning at high speeds.	Heels inward when turning at high speeds.
Less affected by wind.	Greatly affected by wind.

Now, let us look at how a vessel is steered and how it turns. When the propeller rotates, it causes a water-flow across the rudder. Refer to figure 1.3.

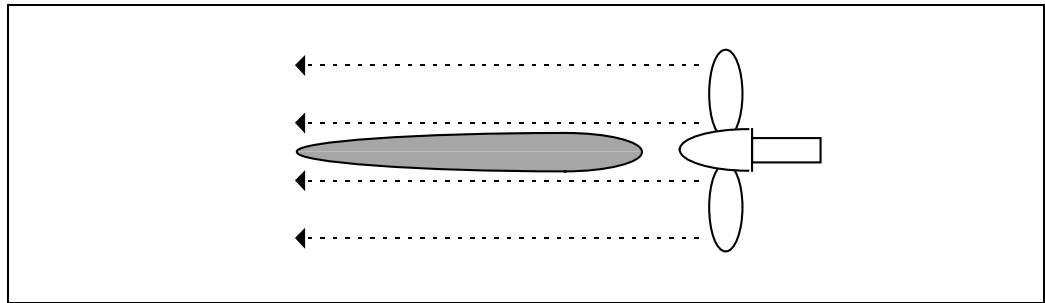

Figure 1.3 Water-flow across the rudder

When the rudder is turned, the water-flow is deflected, causing the vessel to turn. Refer to Figure 1.4.

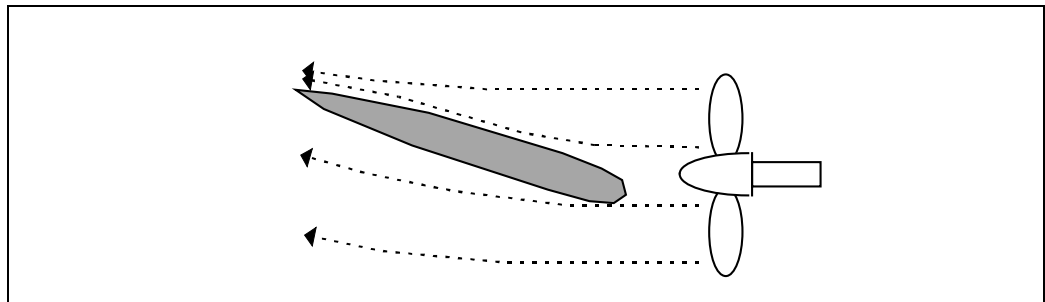

Figure 1.4 Water-flow across the rudder

To turn more quickly, we will have to either :

- increase the rudder angle,
- or, increase the water-flow across the rudder,
- or both.

The rudder loses its turning effect, however, if it is turned beyond angles of 40° . Most vessels are designed so that the rudder cannot normally be turned beyond 35° .

More water-flow over the rudder can be achieved in two ways, by the increase in the vessel's speed, or by the increase in propeller-wash over the rudder.

Alternatively, some vessels are steered and turned by changing the direction of the propeller thrust. Refer to Figure 1.5.

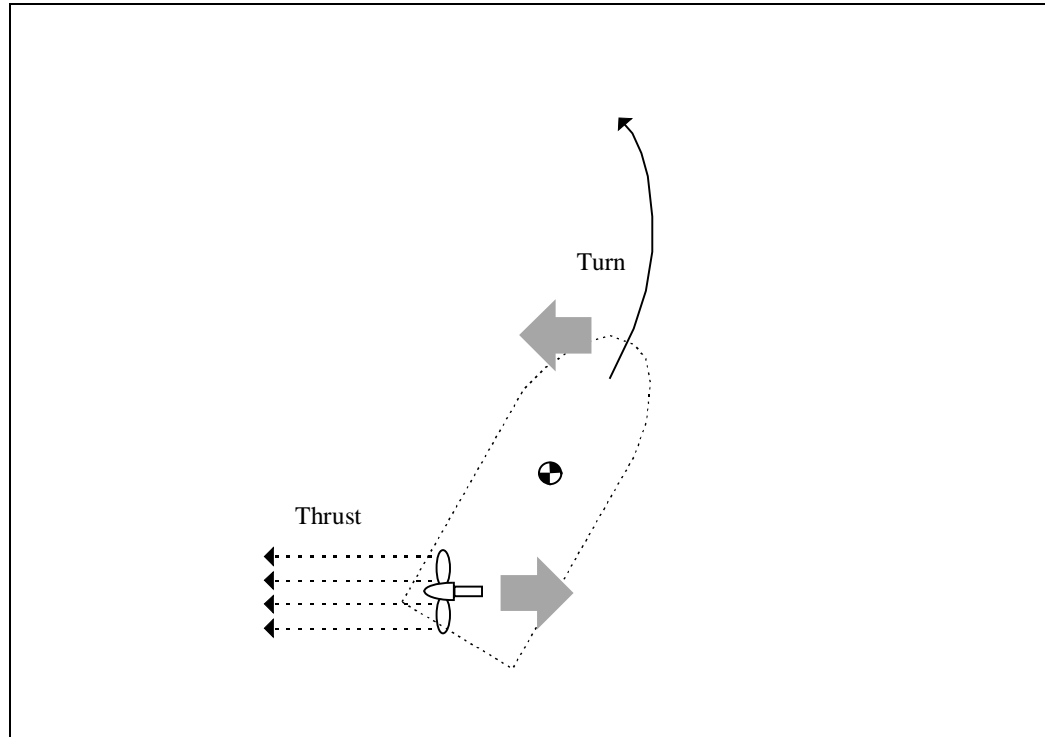

Figure 1.5 Turning by changing the direction of thrust

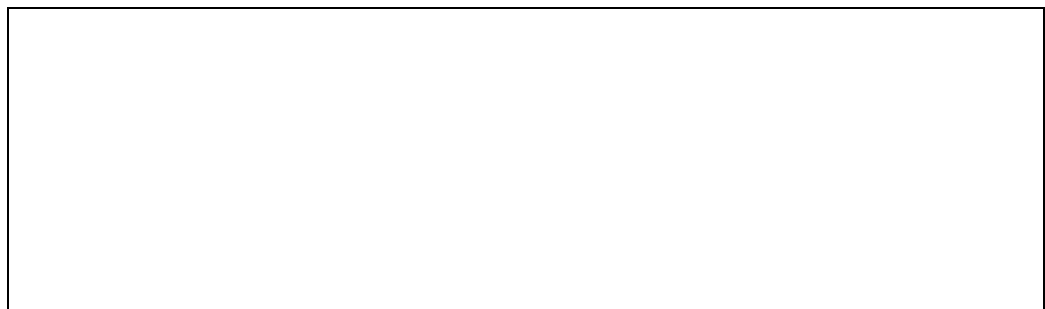

Figure 1.6 Outboard engine

This is characteristic of vessels propelled by outboard engines (Figure 1.6) and certain specialised propulsion units.

On a vessel fitted with twin propellers, we can also steer and turn it using the engines since the propellers are offset from the centreline.

If the starboard engine is driven ahead whilst the port engine remains stopped, forces created tend to turn the vessel to port.

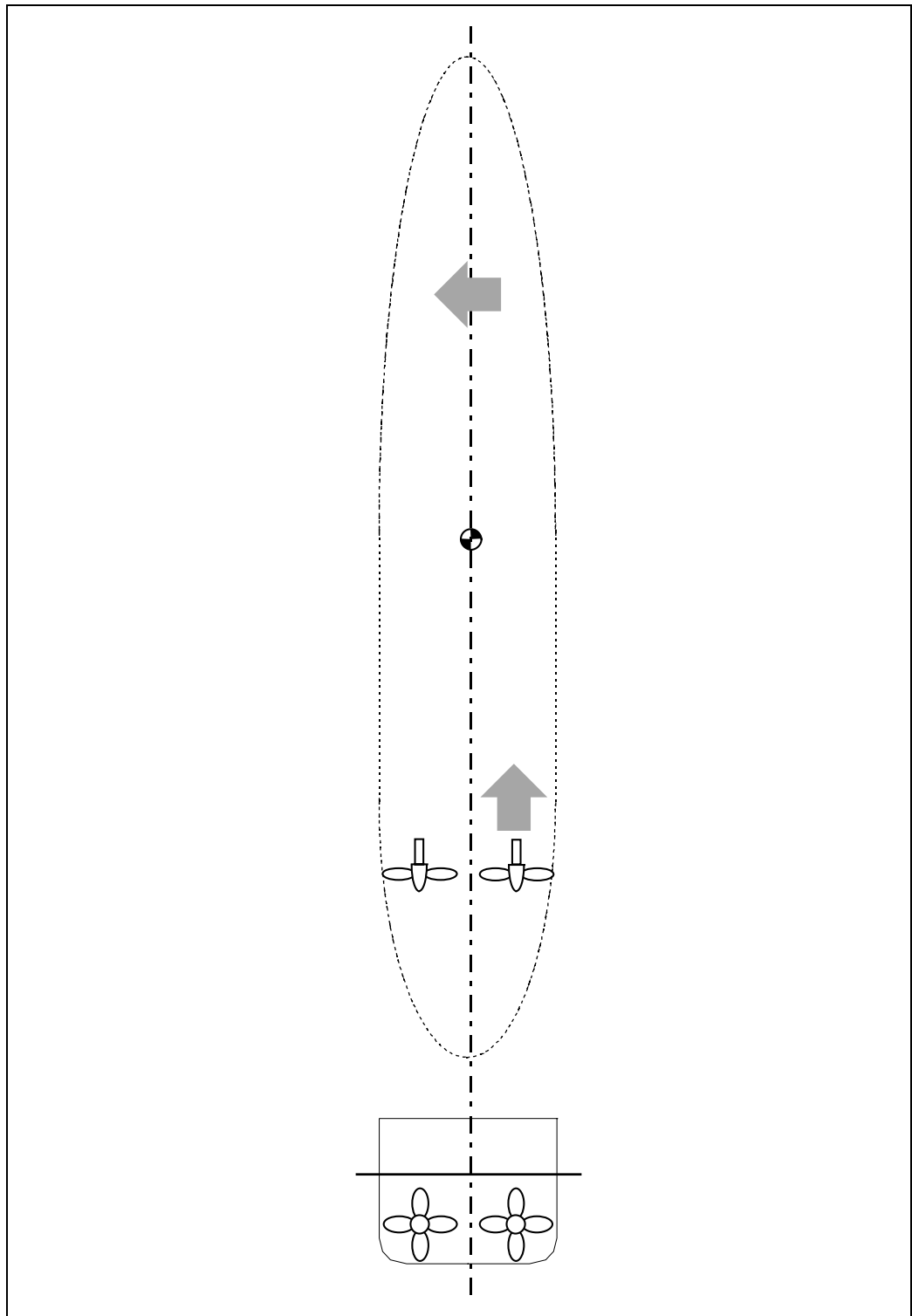

Figure 1.7 Turning with twin propellers

When the propeller rotates, besides propelling the vessel in the appropriate direction, other forces are also created. Refer to Figure 1.8.

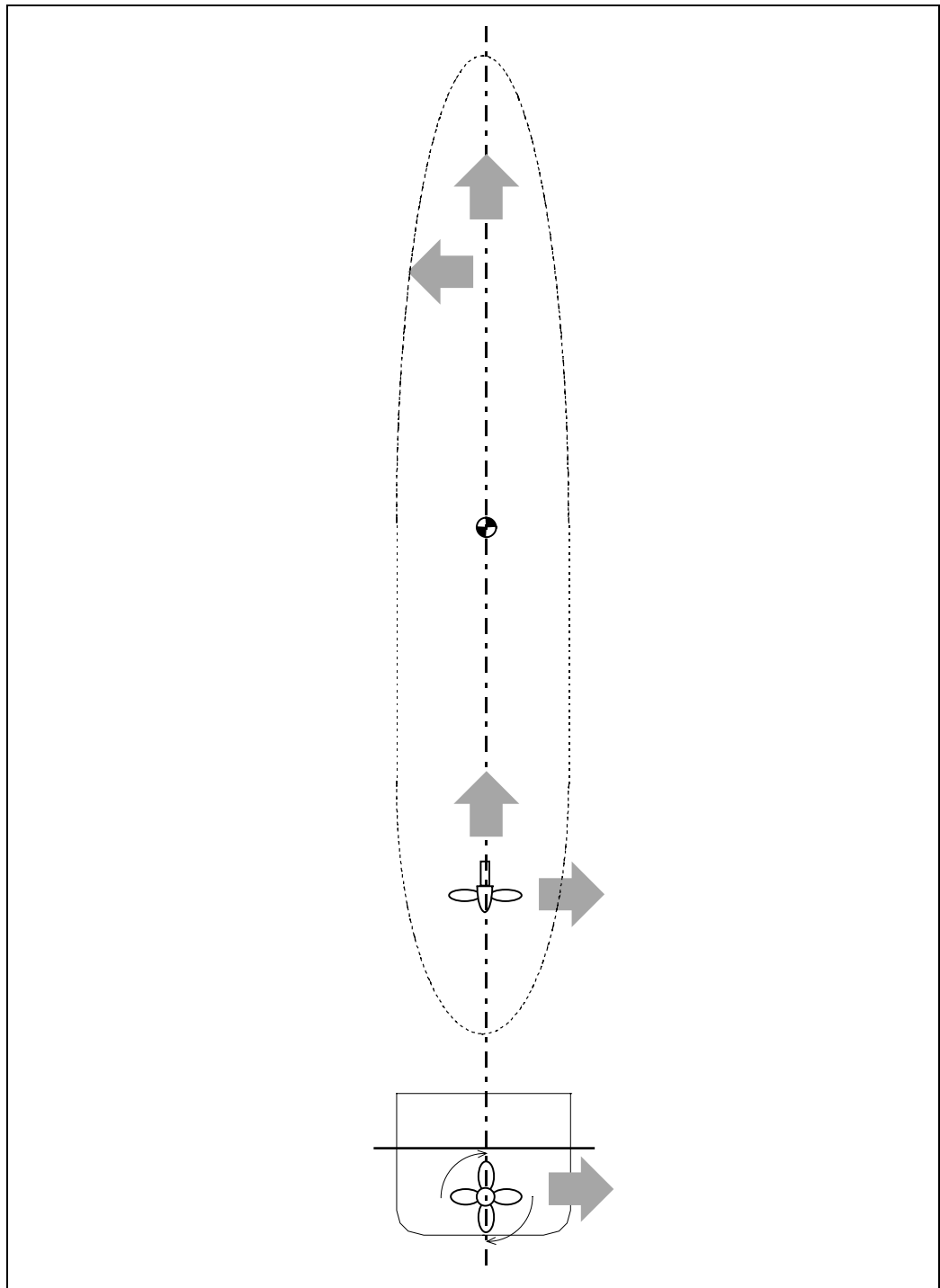

Figure 1.8 Transverse Thrust (Paddlewheel effect)

A propeller tends to act as a paddle wheel. In Figure 1.8, the propeller rotates clockwise to propel the vessel ahead, but it also causes the stern to cant to starboard slightly. As a result, the bow cants to port. This is called *Transverse Thrust*.

When it rotates counter clockwise to propel the vessel astern, the opposite happens. The stern cants to port and the bow to starboard besides propelling the vessel astern. *Transverse thrust* may somewhat seem to be a disadvantage but with practice, this can be put to good use when manoeuvring a vessel. We will see how, in the later part of this section.

Transverse thrust is most significant when the vessel is initially propelled ahead or astern from a stationary position. When the vessel has gathered some headway, transverse thrust is less noticeable.

We have discussed how the rudder steers the vessel when it is moving ahead. Now what happens when the vessel goes astern? Unfortunately, most single- screw vessels do not steer very well when going astern.

The rudder has very little effect on when moving astern. Transverse thrust has a much greater effect instead.

What direction does the propeller rotate when going ahead ? Viewed from astern, most propellers are designed to turn clockwise when going ahead. These are called *right-hand* propellers or *right-hand screws*.

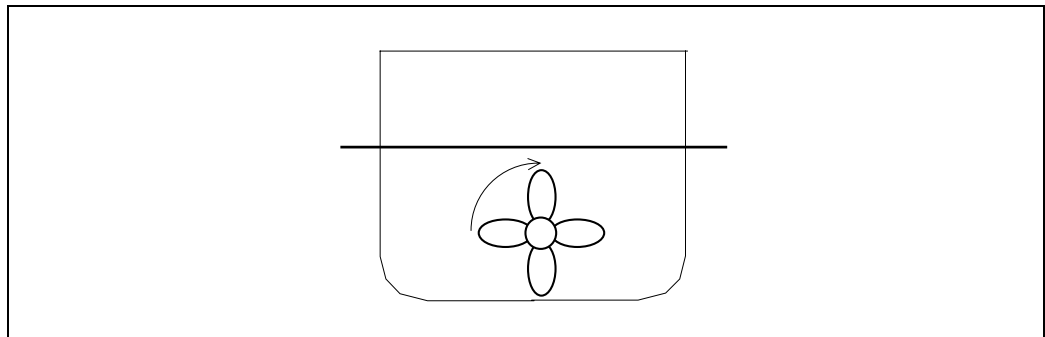

Figure 1.9 Single, *Right-Hand* Screw

On a vessel propelled by twin propellers (*twin screw*) the starboard propeller is usually a *right-hand screw* and the port propeller, a *left-hand screw*. This is termed *outward-turning*.

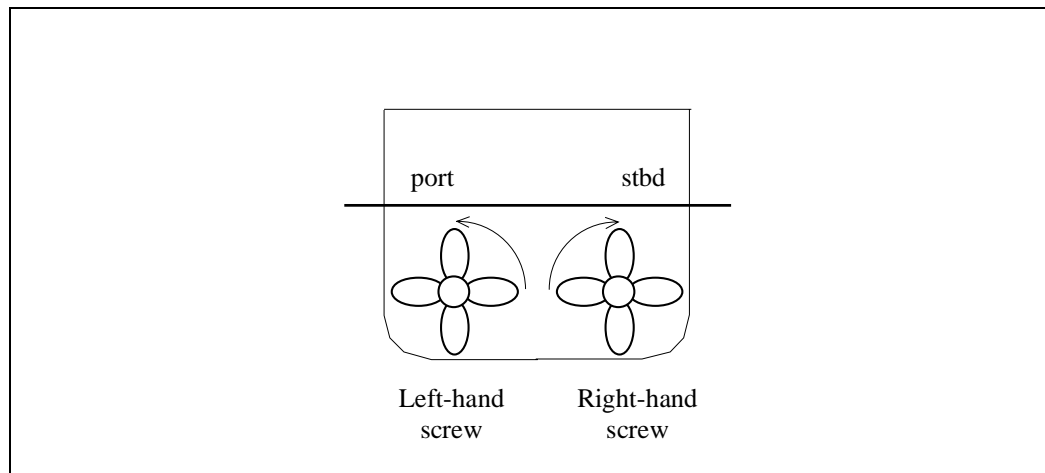

Figure 1.10 Twin, *Outward-Turning Screws*

We now know how the vessel is propelled. How do we stop the vessel, once it is in motion, for example if it is moving ahead? First, we can stop the propulsion ahead by stopping the engine. The vessel slows down gradually and finally comes to a stop. We can also apply astern propulsion to stop the vessel quickly.

When the vessel is moving ahead at high speeds, an attempt to stop the vessel immediately by putting the engine(s) astern may cause serious damage to machinery.

It takes a bit of time and power to set a vessel in motion, particularly the heavier, displacement types. Once in motion, it also takes time for the vessel to be stopped. The stopping distances vary a great deal with the following factors:

- Actual speed
- Planing or displacement hull
- Light or heavy displacement (general size of vessel)
- Shape of hull (sleek or broad)
- Efficiency of astern propulsion

2. EXTERNAL CONDITIONS

The manner in which a vessel is operated and maneuvered depends largely on the external conditions.

2.1 Tides and Currents

Before you take a vessel out to sea, you should always obtain information on the tides, tidal streams and currents for the area of operation. This will give you an idea on the direction and strength of the current or tidal stream to make sufficient allowances for rounding obstructions, anchored vessels and making approaches towards moorings or the berth, etc.

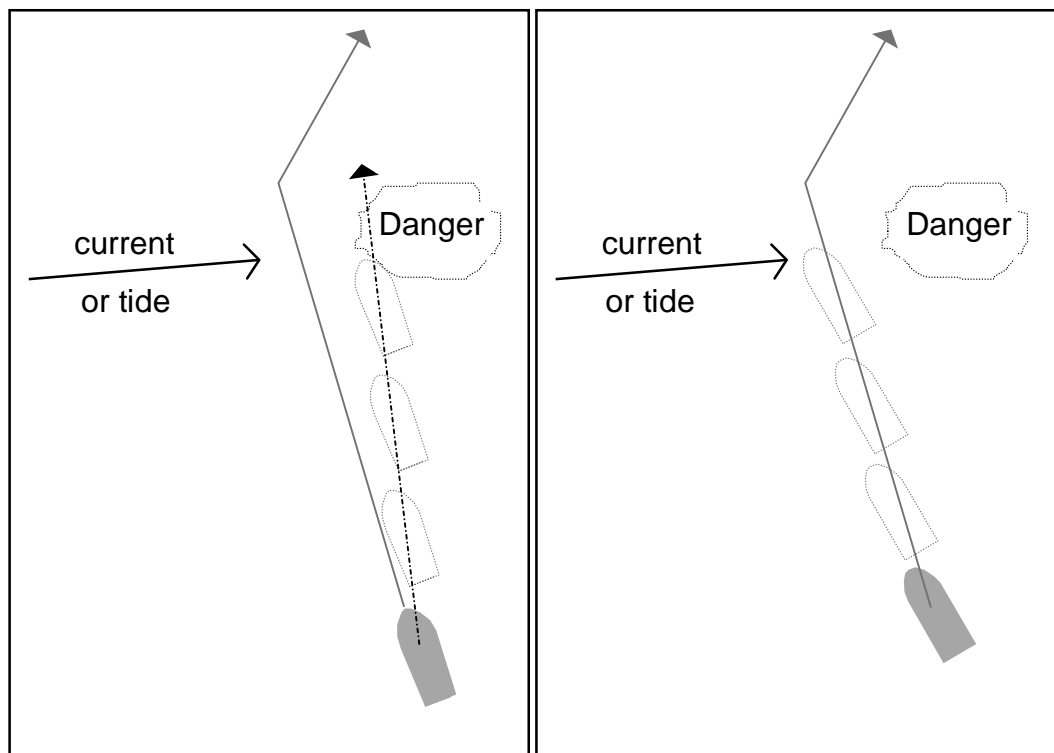

Figure 1.11 Making allowance for current or tide

A convenient method of checking the vessel's progress through the water is by carefully observing the coastal features. We will discuss more about this later in Section 8.

2.2 Heavy Weather

Heavy weather poses several problems in maneuvering most vessels, especially smaller craft. In heavy weather, smaller vessels face greater risks of :

- capsize
- pooping
- broaching

In general, we try to keep either the bow or the stern into the sea. It is more difficult to capsize the vessel if the bow or the stern is pointing into the direction of the seas. This is because the length of a vessel is always greater than its width.

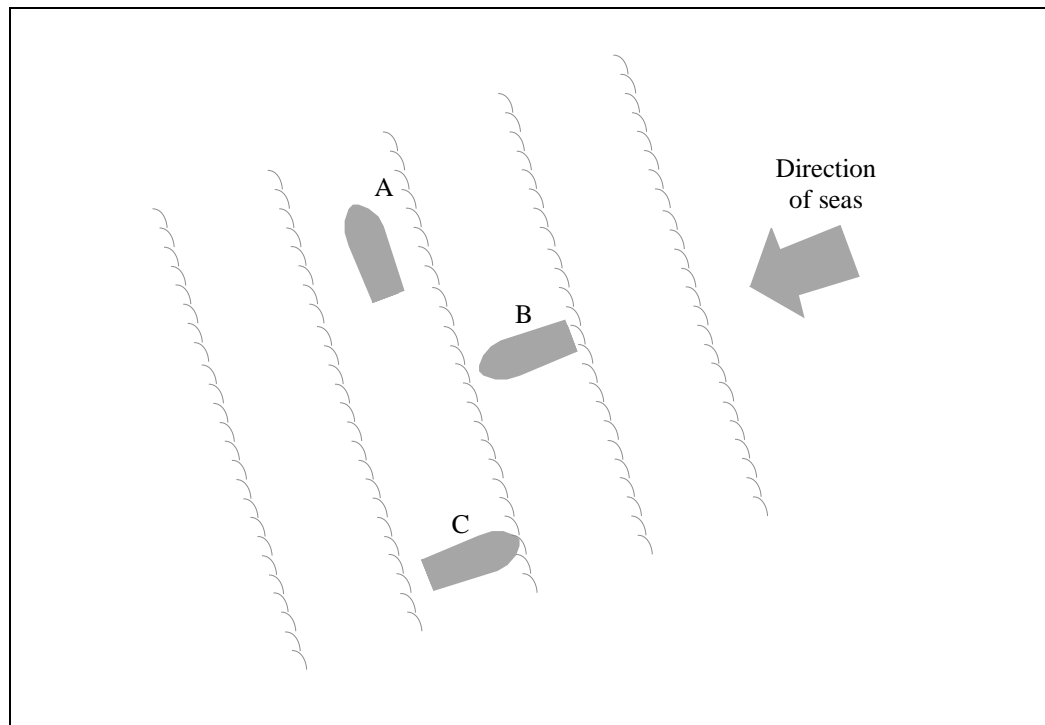

Figure 1.12 Risk of Capsize

Refer to Figure 1.12 above.

Vessel A has the seas on the beam, causing heavy rolling and risking possible capsizing.

Vessel B has the seas astern. There is less rolling and less risk of capsizing.

Vessel C has the seas ahead. Similar to Vessel B, there is less rolling and thus less risk of capsizing. This is the preferred option as it offers better control of the vessel.

Pooping is the term used to describe the seas breaking over the stern of the vessel. This can also be dangerous particularly for an open decked vessel. Large amounts of water can quickly flood the vessel, causing additional problems.

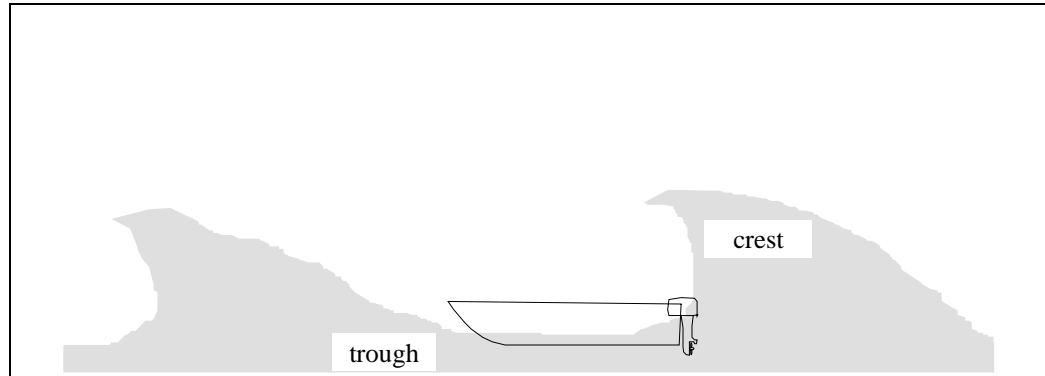

Figure 1.13 Pooping

Broaching:- when a steep following sea causes the vessel to 'surf' forwards uncontrollably, the bow tends to 'dig' into the wave ahead, decelerating the vessel rapidly. The forces on the stern will cause the stern to swing violently to the left or right and the vessel will come to rest broadside to the waves. A rapid "broaching" may cause a capsizing.

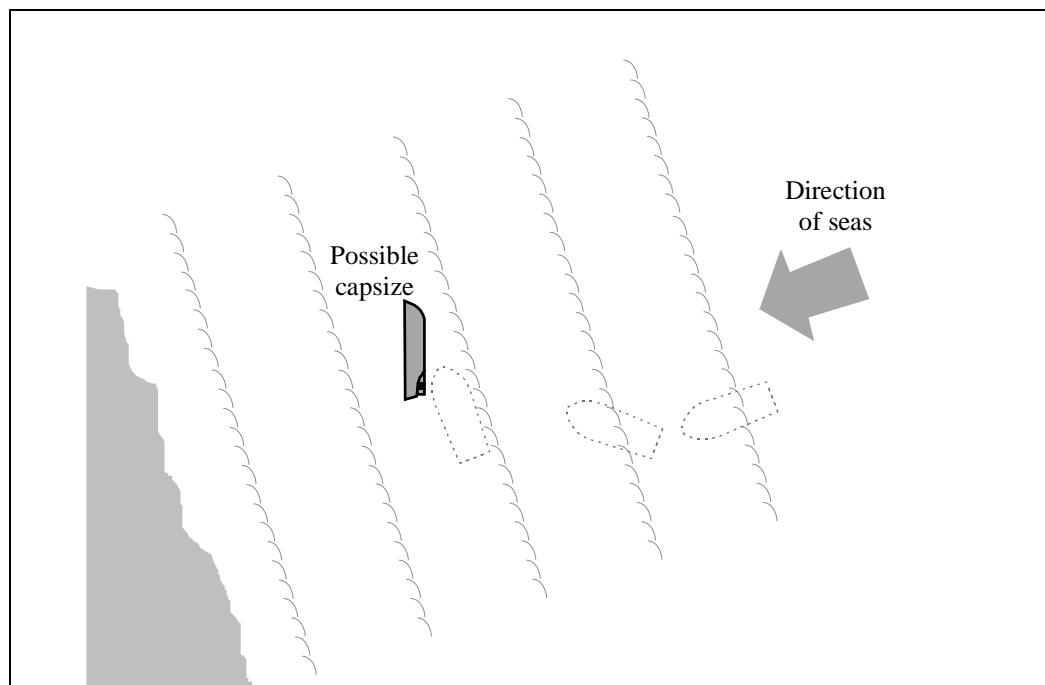

Figure 1.14 Broaching

As we know, the best way to avoid a possible capsizing in heavy seas is to keep the bow into the seas. The next best alternative is to have the stern into the seas. Remember, if the seas get too rough, keeping the stern into the seas may present additional risks of pooping and even

surfing out of control. If you are caught in this situation, the only option left now is to turn the vessel around to head into the seas. It may be also necessary to turn the vessel around to avoid running into an obstruction ahead such as the coast, shallow water, etc.

Turning the vessel around in heavy seas is rather tricky. It should be timed to ensure that the vessel has completed the turn by the time the next large wave reaches it. Refer to Figure 1.15.

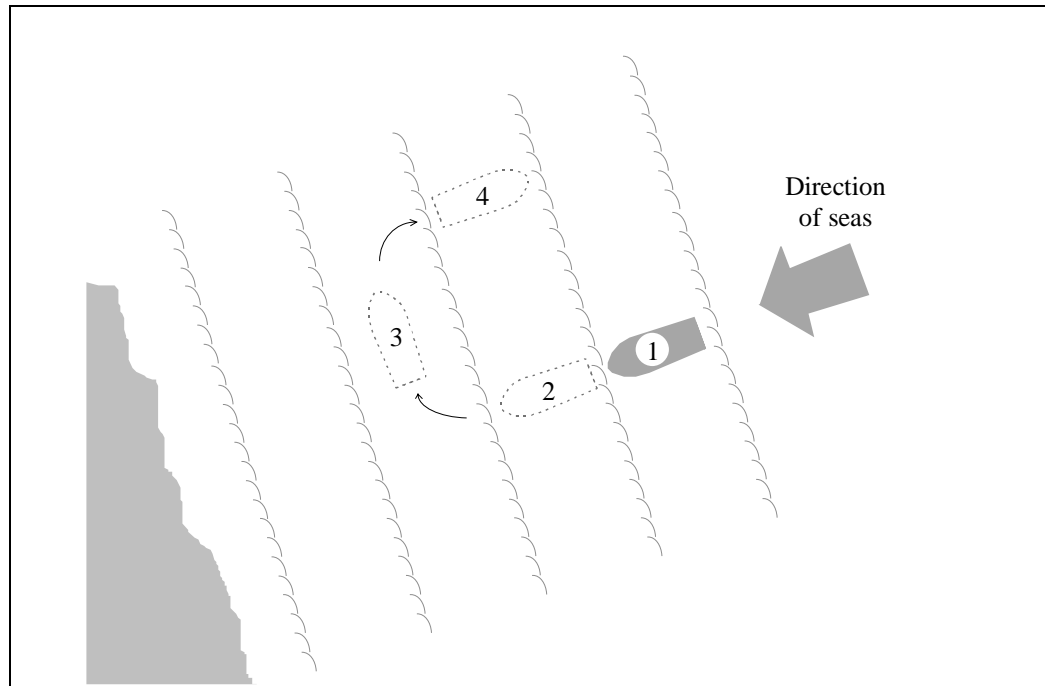

Figure 1.15 Turning in heavy seas

The actual turn should be done within the trough, not on the crest. Attempting to perform the turn on a crest could result in capsize. The turn has to be made quickly to minimise the time when the seas are abeam.

Wherever possible, avoid taking a vessel out into heavy weather or if heavy weather is expected within the period the vessel is out at sea. Consider alternatives, as this is the safest way to avoid unnecessary risks and running into trouble. If the vessel cannot avoid heavy weather whilst at sea

- maneuver vessel to avoid capsize, pooping or broaching
- lash up all loose gear
- close all deck openings to maintain watertight integrity
- ensure freeing ports are working properly & not blocked
- ensure survival equipment is ready for immediate use
- maintain communications with shore radio stations
- check that the fuel tank in use has sufficient fuel

2.3 Manoeuvring around large vessels

There are several considerations when manoeuvring around large vessels. As a general rule, give all vessels plenty room when passing. Everyone likes to go in close to have a better look but this may be dangerous and should be avoided.

Large vessels may have only limited manoeuvring room due to their draft in relation to the available depth of water. Avoid impeding their safe passage and keep a good, safe distance off. Note that large vessels manoeuvre with a much greater degree of difficulty in confined waters and also take much longer to stop.

When any vessel moves, the flow of the water around the hull causes zones of high and low pressure. The effect increases with the size of the vessel and its speed.

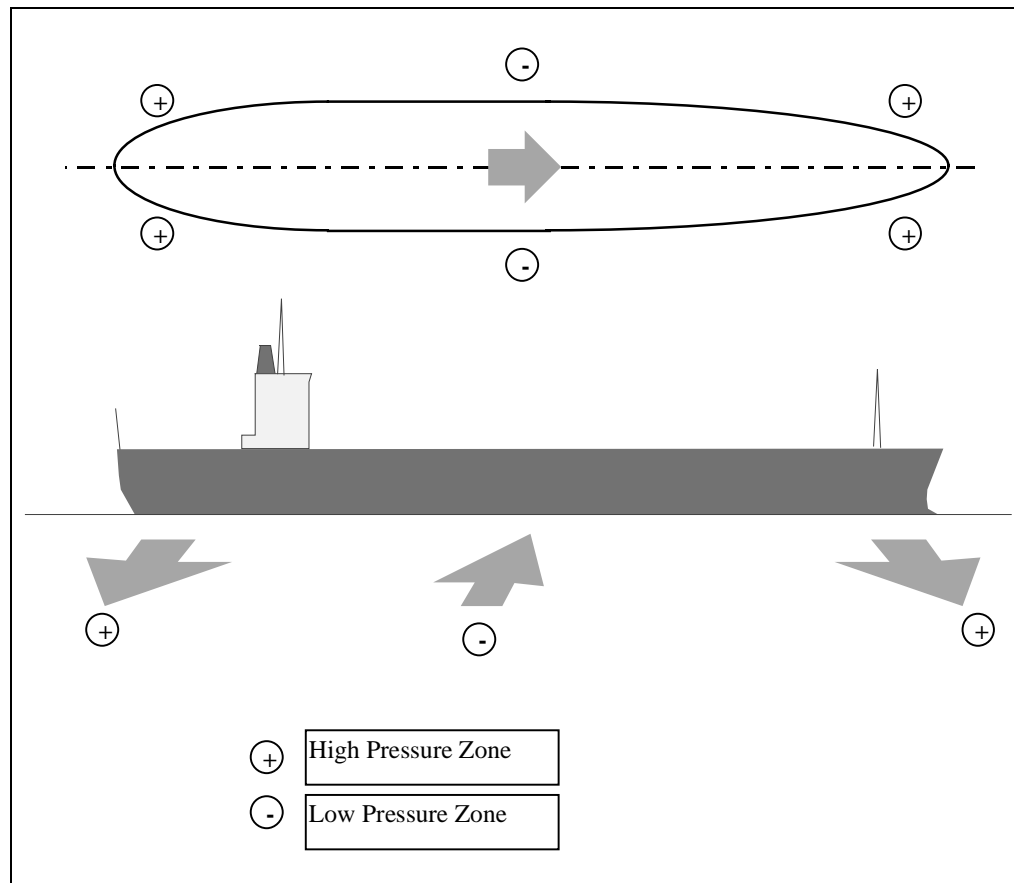

Figure 1.18 Pressure zones of large vessels making way

A small vessel approaching or passing close to a large vessel will very quickly notice the effect of the pressure zones. This can easily cause the small vessel to lose control and risk danger of collision or even being drawn into the propeller suction. Large vessels require huge amounts of power for propulsion. Be careful not to be caught in the turbulence caused by the propeller wash.

From the enclosed bridge of a large vessel and the obstructions around it such as masts, other structures and cargo, small vessels around might be obscured from the view of watchkeepers. Often, small vessels are not detected on radar at long ranges, either. It is often easier for the skipper of a small vessel to spot the large vessel first and keep out of the way. Thus, give all large vessels a wide berth and do not cross ahead of a large moving vessel at close range.

3. ANCHORING

3.1 Preparation

Let us look at what needs to be done prior to anchoring the vessel.

3.1.1 Select a suitable anchorage

- Ensure that anchoring is permitted at the intended location and there are no underwater cables, pipelines, fish havens and other obstructions in the vicinity.
- The area should be suitably sheltered from weather, seas and strong currents.
- Check that the depth is suitable for anchoring. Ensure that the rise and fall of tide will always leave a safe depth of water under the keel.
- Ensure there is sufficient room for the vessel to swing around at anchor during tide change and in case the anchor drags.
- Check if the sea bottom is suitable for anchoring. Anchors do not hold well on rocky and stony sea bottoms. Avoid anchoring directly on coral as the anchor may get caught and it also causes irreparable damage to the reef.
- Do not anchor in an area that obstructs traffic.
- Check the weather conditions

3.1.2 Prepare the anchor gear

- Check that the anchor, the anchor chain and line are all in good working order.
- Ensure all the attachments between the anchor, the anchor chain, the anchor line are secure.
- Ensure the anchor line is secured to a suitable, strong point of the vessel.
- Clear the working deck of obstructions.
- Lay out the anchor gear to prevent possibility of entanglement during anchoring.

3.2 Letting-Go Anchor

3.2.1 The Approach

- Manoeuvre the vessel at slow speed towards the intended area.
- Observe the direction of the current and wind to assess the effect on the vessel.

- Make the approach to the intended area by stemming the current or weather which ever is stronger.

3.2.2 Manoeuvres

- ① At the final stage of the approach, stop the engine. Allow the vessel to glide in to the intended area.
- ② Engine astern (to stop the vessel)
- ③ Stop Engine. Allow the vessel to drift astern very slowly.
- ④ Let go anchor. Once the anchor reaches the bottom, keep some weight on the anchor line and ease it out slowly as the vessel moves astern. (This helps stretch the anchor chain out on the sea bottom instead of gathering in a heap.)
- ⑤ Allow the vessel to drift with the tide or down wind or till the required length of anchor line is paid out, using the engine if necessary.
- ⑥ When the correct length of anchor line is paid out, secure the line to a suitable strong point on the vessel.

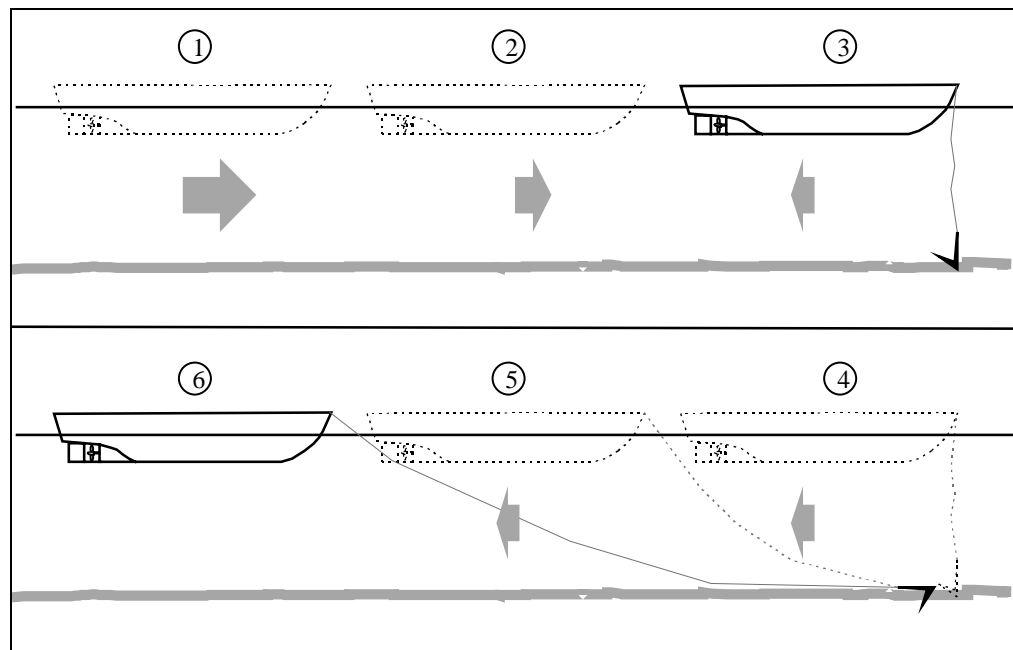

Figure 1.19 Letting-Go Anchor

3.2.3 At Anchor

- Once anchored, observe carefully how the anchor line bears the weight of the vessel to determine whether the anchor is holding.
- Note the position of landmarks nearby for reference in case the anchor drags. Confirm that the vessel has sufficient room to swing around the anchor safely.
- Maintain a proper watch continuously. Be vigilant for signs of danger, anchor dragging, movements of other vessels in the vicinity, changes in weather, etc. Wherever possible, always have the engine ready to be started for immediate use in case of emergencies.

3.3 Weighing Anchor

- Check the direction in which the anchor line leads.
- Start the engine.
- Brief the crew
- Clear the working deck of obstructions..
- Commence hauling-in the anchor line.
- If the anchor line is too taut to haul-in, use the engine as necessary, to manoeuvre the vessel ahead slowly to take the weight off the anchor line.
- Upon weighing anchor, ensure all anchor gear is stowed away properly quickly and the anchor is properly lashed in order to safely proceed to sea.

4. BERTHING & UNBERTHING

Berthing a vessel alongside a wharf is probably one of the most obvious activities of the vessel to the onlookers observing the vessel from ashore. A skipper who berths a vessel smartly and neatly almost immediately wins the respect of all.

4.1 Berthing a Single Screw Vessel

Let us examine the berthing of a single right-hand screw vessel with no wind or tide and use this as a basic model. A right-hand screw vessel is somewhat best suited to be berthed port side to. Remember the stern cants to port due to transverse thrust when the engine is put astern. At the final stage of the approach, the engine going astern stops the vessel and at the same time swings the stern in towards the wharf.

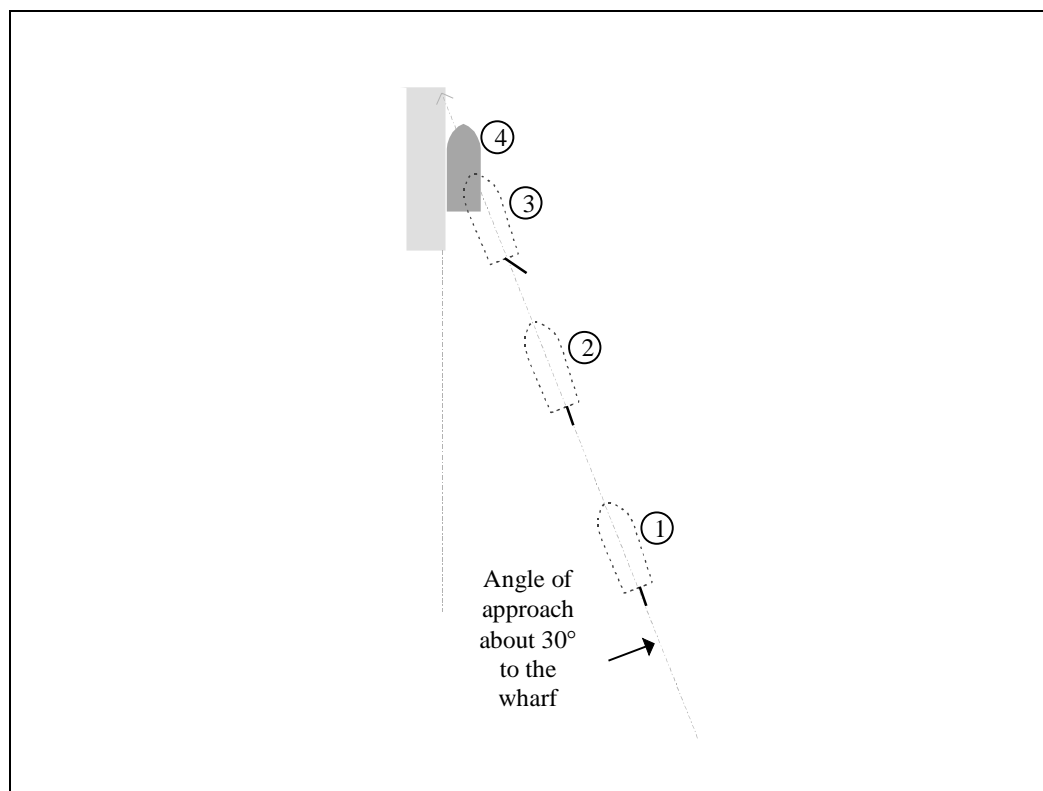

Figure 1.20 Berthing a single right-hand screw vessel, Port side to

- ① Minimal speed for steerageway. (Approach angle about 30° to the wharf)
- ② Stop engine and allow vessel to glide in. Steer to maintain approach course.
- ③ Rudder to starboard (optional)
Engine astern
- ④ Stop engine, rudder amidships

Berthing starboard side to on a single right hand screw vessel requires a slightly different approach. In general, the approach has to be much slower, and at a finer angle to the wharf.

Remember, if the engine is put astern to slow down or stop the vessel, transverse thrust will cause the vessel to sheer to starboard and collide into the wharf. Thus, we avoid a situation where astern propulsion is necessary.

However, if for some reason the engine has to be put astern, it is still possible to reduce the effect of the transverse thrust. First, swing the vessel slightly to port before putting the engine astern.

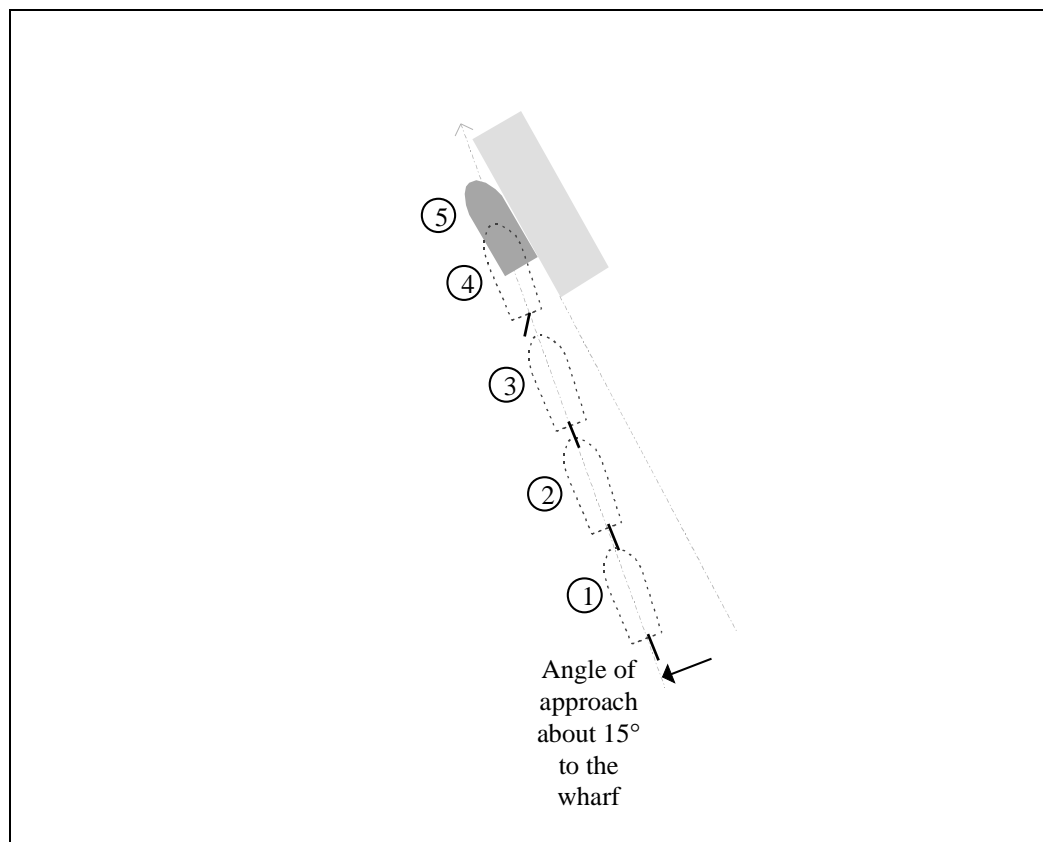

Figure 1.21 Berthing a single right-hand screw vessel, Starboard side to

- ① Stop engine and allow vessel to glide in. Minimal speed for steerageway. (Approach angle about 15° to the wharf)
- ② Maintain a very slow approach.
- ③ Vessel is almost stationary.
- ④ Rudder to port, brief kick ahead on engine (to swing the stern in towards the wharf)
- ⑤ Stop engine, rudder amidships.

4.2 Berthing a Twin Screw Vessel

An outward turning twin screw vessel generally has more manoeuvrability than a single screw vessel. For berthing and unberthing, you may use the engines alone to turn a small vessel on the spot. With the effective use of engines and rudder it is possible to manoeuvre the vessel into very confined areas.

At the final stage of the approach, the Starboard Engine is put astern to stop the vessel and at the same time swing the stern in towards the wharf.

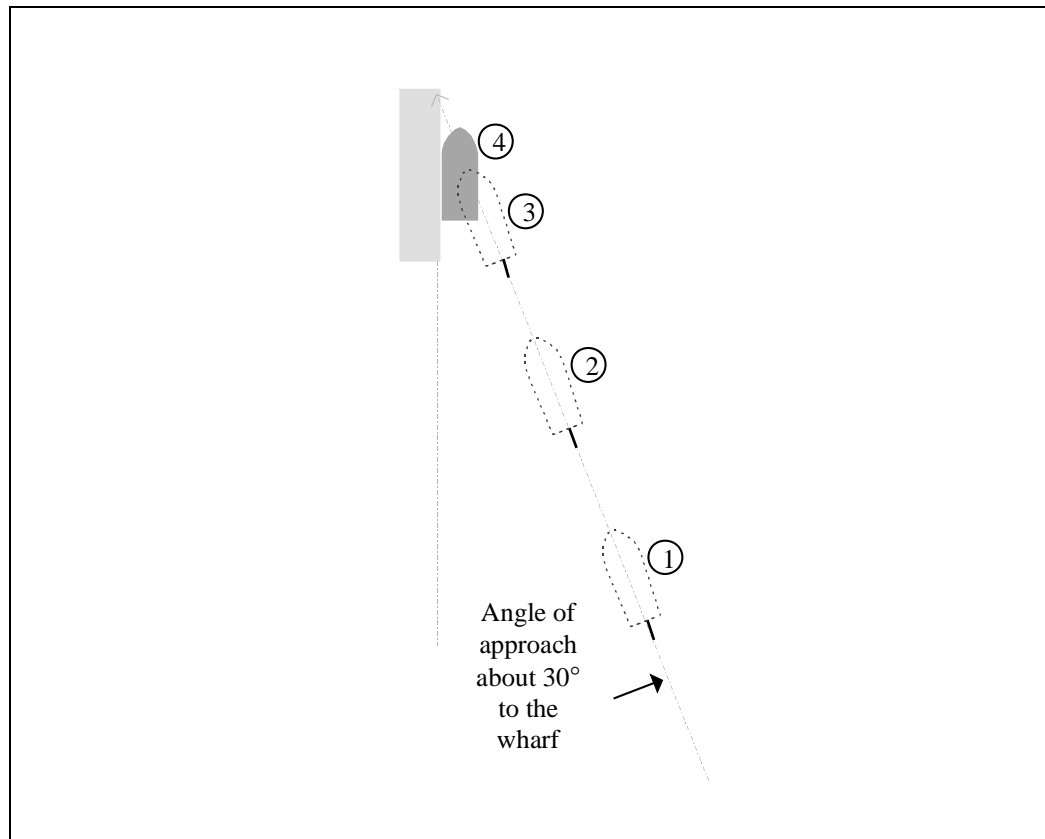

Figure 1.22 Berthing a twin outward turning screw vessel, Port side to

- ① Minimal speed for steerageway. (Approach angle about 30° to the wharf)
- ② Stop engine and allow vessel to glide in. Steer to maintain approach course.
- ③ Rudder amidships, Starboard Engine astern.
- ④ Stop Starboard Engine.

4.3 Allowances for Wind

Strong onshore winds (winds blowing towards the wharf) assist the vessel in berthing. However, make sufficient allowance during the approach, steering away from the wharf. In very strong winds consider the use of the anchor to prevent heavy impact onto the wharf.

4.4 Unberthing

Let us now look at unberthing a vessel. Like before, we refer to a single right-hand screw vessel and assuming no wind or tide. The most convenient option is to go stern-out first.

There are a few considerations, however. When the engine is put astern, transverse thrust brings the stern back towards the wharf. Thus, the first movement should be to get the stern away from the wharf, which also causes the bow to come in contact with the wharf at a point further forward. Consequently, depending on the shape of the bow, we might need more fenders forward to prevent possible damage.

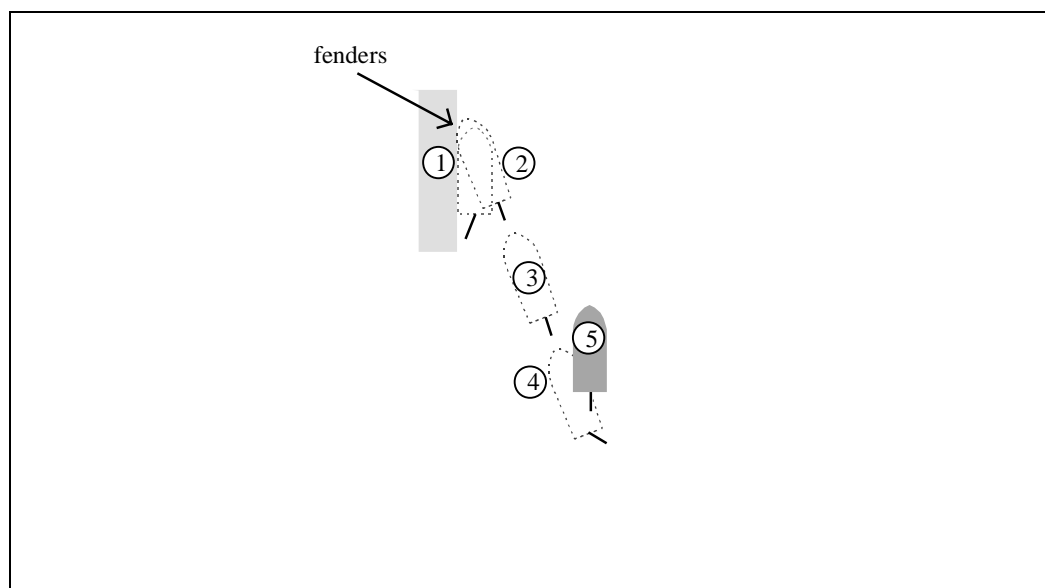

Figure 1.24 Unberthing a single right-hand screw vessel from a wharf

- ① Full Port Rudder, brief kick ahead (to swing the stern away from the wharf)
- ② When the stern is at a suitable distance from the wharf, midships rudder, engine astern.
- ③ Watch carefully that the stern is still at a safe distance from the wharf as the engine goes astern.
If the stern is coming close to the wharf, repeat steps ① & ②
- ④ When the vessel is at a safe distance from the wharf, stop engine
- ⑤ Starboard Rudder, engine ahead. Turn the vessel to steer the required course.

On a twin screw vessel, the same manoeuvres apply. A twin screw vessel has better control of the astern movement through efficient use of the engines.

4.5 Unberthing in an Onshore Wind

It may be difficult to unberth a vessel in an onshore wind using the method just described. Try the use of a spring-line to assist in holding the vessel in position whilst attempting to swing the stern out. This helps prevent damage due to the vessel's movement along the wharf in attempting to unberth.

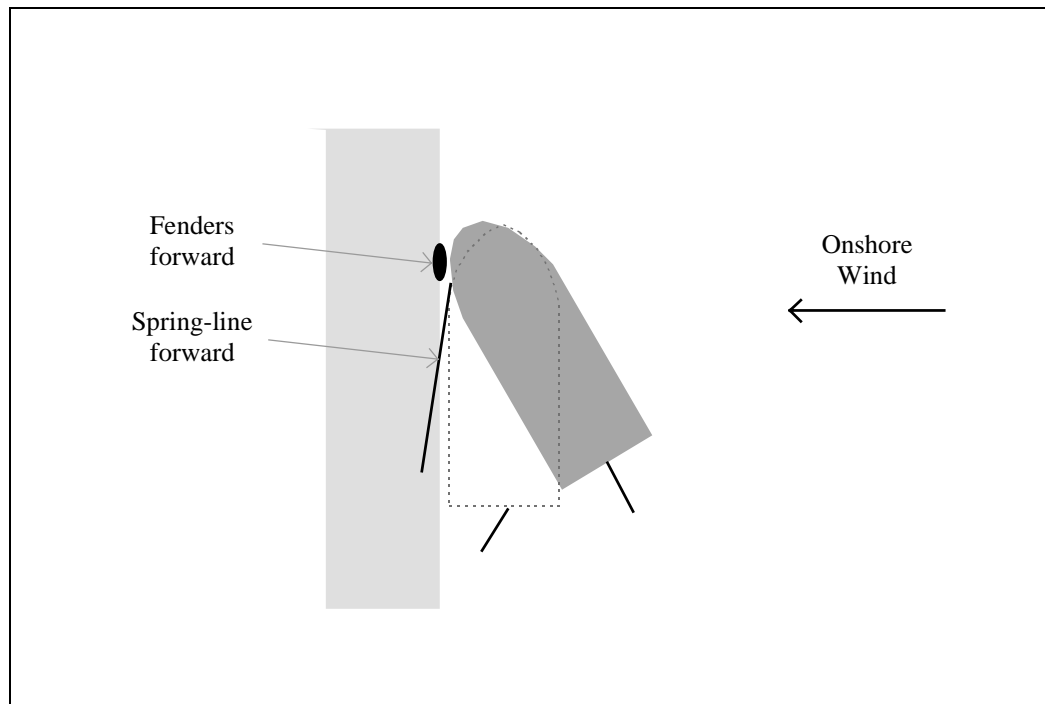

Figure 1.25 Unberthing a single right-hand screw vessel in an Offshore Wind

5. TOWING OPERATIONS

Vessels may require to be towed for a variety of reasons such as a disabled engine, damaged structures, etc. Some vessels are designed without self propulsion like barges and platforms, and require to be towed to get anywhere. Tugs are purpose built vessels for towing operations and are well set up in terms of equipment, design and safety features.

The average vessel may also perform a tow out of sheer necessity but there are certain considerations you need to make:

- Fittings and structure of the vessel are not specifically designed for towing
 - ◇ May not be strong enough to bear the weight or be shock loaded.
 - ◇ May cause damage or stress to structure of vessel
 - ◇ May cause undue wear on tow line
- Manoeuvrability of the towing vessel is restricted
- The rope used for towing may not be completely suitable as a tow line
- The possible absence of expertise in towing operations

In heavy weather, towing may pose additional risks. Additional strain and shock loading is exerted on the tow line, the fittings and structures of both vessels. Several measures should be done on both the vessel in tow and the towing vessel.

- keep personnel clear of tow line. Warn everyone of the risks of parting tow line and possibility of damage to vessel's structure
- use a longer tow line provides better shock absorption
- use anchor chain as shock buffer if available
- secure the tow line at more than one securing point to share the strain
- take steps to prevent chaffing of tow line.

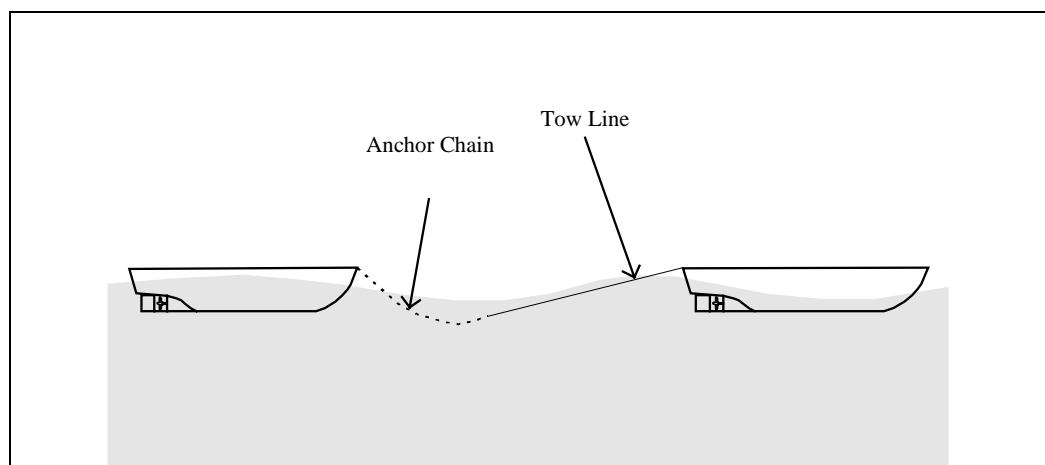

Figure 1.27 Towing in Heavy Weather

When towing is done in confined waters, manoeuvring with a long tow becomes a problem. To achieve better manoeuvrability and control, several measures may help:

- reduce the length of the tow line
- switch to an alongside tow

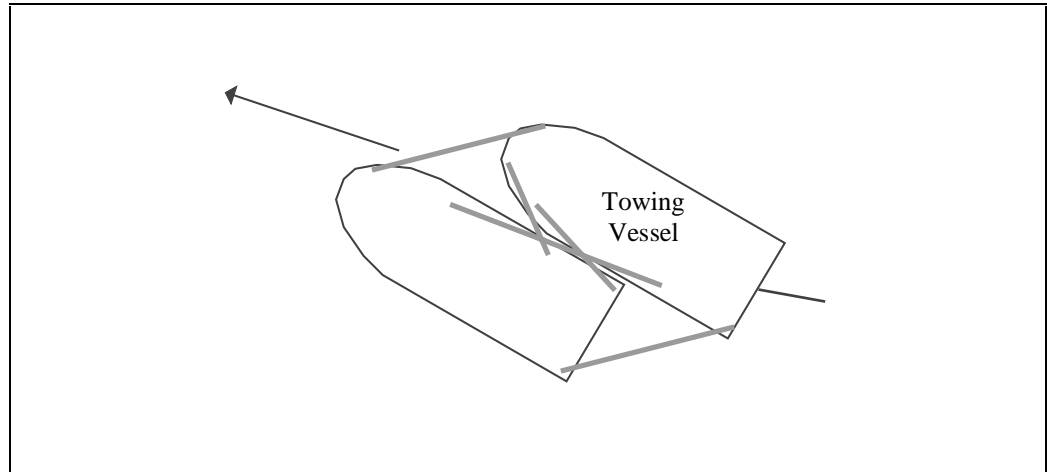

Figure 1.27 Alongside Tow

Section 2

Emergency Procedures

1. MARINE CASUALTIES

Whenever a vessel is involved in an accident, the master must make every effort to limit the damage and maintain the safety of the vessel and all persons on board.

In some cases, the master is legally obliged to assist other vessels and persons who may also be involved in the accident. Most marine authorities require the master to report any accident that results in major damage to the vessel, other vessels or things, or injury to a person. Such incidents are usually called "marine casualties".

Examples of marine casualties include :

- collisions with other vessels or things;
- running aground;
- sinking of a vessel;
- abandoning a vessel;
- major damage to a vessel resulting from a fire;
- death or injury to a person due to an accident on board.

Each country has its own regulations regarding the reporting of marine casualties. You should find out what your obligations are, from your local marine authority.

You would have learned about accidents involving fire, abandonment and survival when you obtained your safety certificate. In this section, we will discuss collisions and groundings.

1.1 Collisions

A vessel continually runs the risk of colliding with other vessels and things such as buoys, jetties and offshore installations. In all cases, the damage to the vessel can be very severe and in some cases the vessel may even sink. Collisions with other vessels are particularly dangerous if the colliding vessels are proceeding at high speed.

If a collision with another vessel cannot be avoided, you should try to manoeuvre your vessel in such a way that the impact is minimised. Figure 2.1 shows a situation where two vessels are about to collide.

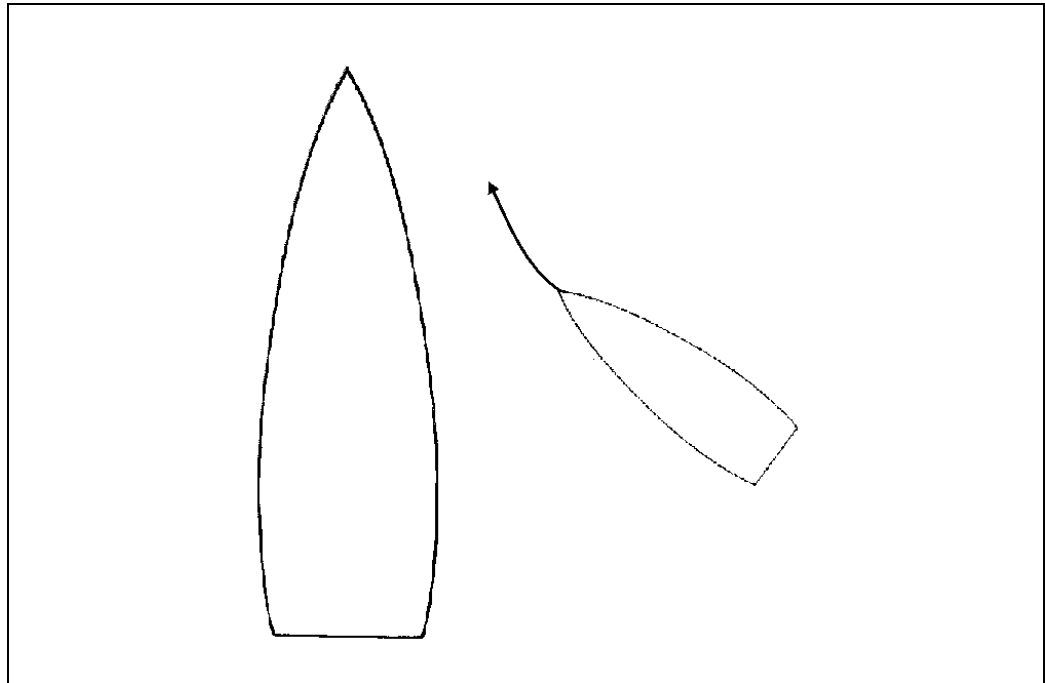

Figure 2.1 Lessening the impact of collision

The smaller vessel turns to starboard so that instead of hitting the larger vessel with full momentum, the vessels only suffer a glancing blow.

Sometimes though, two vessels may collide in such a way that one vessel gets embedded in the other vessel as shown in figure 2.2. In this case it is best not to try and free the vessel as one vessel is plugging the gash on the other vessel. If the vessels were to separate, the vessel with the big gash may start taking in water rapidly and sink.

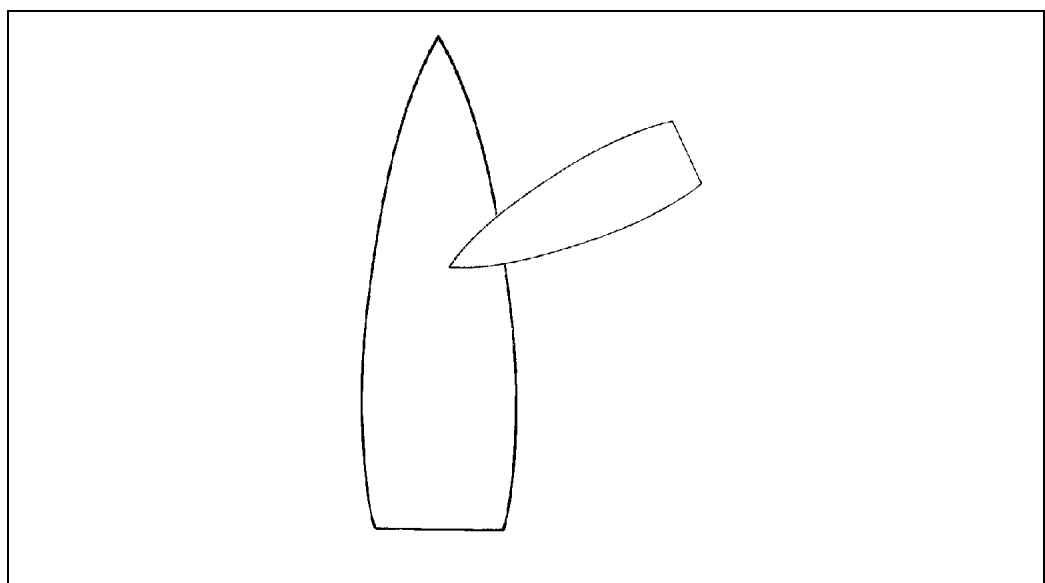

Figure 2.2 Vessels locked together

Once you realise that collision is imminent, shout a warning to those on board and make a sound signal if you have time. Try to manoeuvre the vessel so as to lessen the impact. If the collision does take place, stop all engines. Get every person on deck and close all watertight doors, portholes and other openings. This action will limit any flooding that takes place.

If you have to go below the deck after a collision, make sure that you do not get trapped as the water floods in.

You should find out as soon as possible if any person from your vessel is missing. Give first aid to people who may have been hurt in the collision.

Once you have ascertained the extent of damage to your own vessel and determined that it is not in immediate danger, you should offer assistance to the other vessel if required.

You must contact the other vessel and find out its name and the place it is registered at. You should give similar details of your own vessel to the master of the other vessel.

Finally, you should inform your marine authority of the incident. Sometimes an inquiry may be conducted over the accident. Therefore it is a good idea to make a note of all events that take place so that you do not have to rely on your memory at a later stage.

1.2 Groundings

Grounding means that a vessel has run over an obstruction such as a reef, rock or beach. The extent of damage suffered by the vessel will depend to a large extent on the nature of the bottom. Generally, a vessel will suffer more damage when it runs aground on a rock than on a sandy beach.

The main points to consider are summarised below.

- Stop the engines immediately. Do not go astern until you have assessed the situation.
- Raise alarm.
- Check for hull damage and take soundings of all tanks.
- Check if any person has suffered injuries.
- Take soundings of the area to determine which part of the vessel is resting on the bottom.
- Check whether the tide is rising or falling. If the tide is rising, the vessel may be able to free itself.

- Take measures to stop the vessel from swinging due to the action of wind and waves, and to prevent it from going up any further. This may be done by laying out the vessel's anchor.
- If grounded on a falling tide, it may be necessary to brace the vessel so that it will stay upright.
- Inform the local marine authority by radio. If necessary, send an Urgency Call and message on the radio. If the vessel is in great danger and immediate assistance is required, send a Distress Call and message on the radio.

1.2.1 Refloating a Grounded Vessel

If your vessel does not come off at high tide or it is not possible to free the vessel by using the engines alone, there are several actions that you can take to refloat your vessel.

1. You can reduce the draft of your vessel by discharging or jettisoning weights such as cargo.
2. You can shift weights such as people, fuel, cargo and water away from the grounded part of the vessel.
3. You can seek assistance from other vessels to pull you free.
4. You can lay your anchor (or anchors) in such a position that you can haul the vessel free. Figure 2.3 shows one such arrangement. You will need a boat to transport the anchor. A second anchor (if available) can be used to back up the first anchor. As a general rule, maximum advantage will be gained by placing the anchor as far away from the vessel as possible.

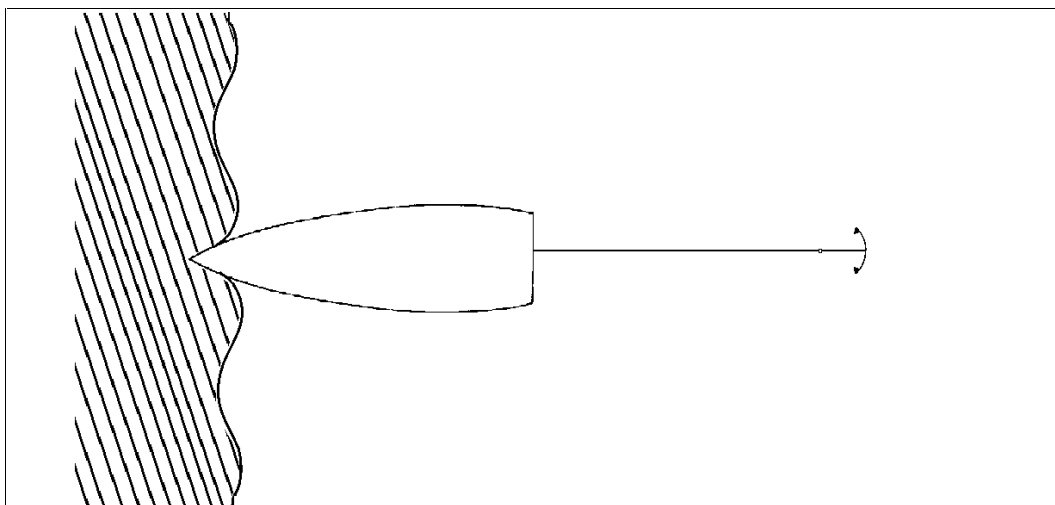

Figure 2.3 Placement of anchor for refloating (*not to scale*)

2. DISABLED VESSEL

If your vessel suffers loss or damage to the rudder or propeller, you will lose the ability to control the vessel. In such cases, your first priority is to ensure that your vessel is safe. In confined waters, the vessel runs the risk of running aground. In open waters if the seas are rough, the vessel faces the risk of being overwhelmed by waves. If there are other vessels nearby, the risk of collision is increased.

In shallow waters, the best option may be to drop anchor immediately. Once the vessel is safely anchored, you will have time to think about the next course of action.

In open waters, if the weather is calm, you can hoist "Not Under Command" signal as required by the Collision Regulations and drift while you investigate other possibilities. Collision Regulations are dealt with in detail in section 4 of this learner's guide.

If the seas are rough, there is danger of the vessel capsizing as it will always lie beam-on to the sea. You can hold the vessel's head towards the oncoming seas by streaming a sea anchor. You may have to spread oil around the vessel to restrict the waves from breaking.

On some vessels, it may be possible to rig sails or row towards land if the propeller is lost. If a vessel has lost its rudder, it may be possible to rig a jury rudder by using materials available on the vessel.

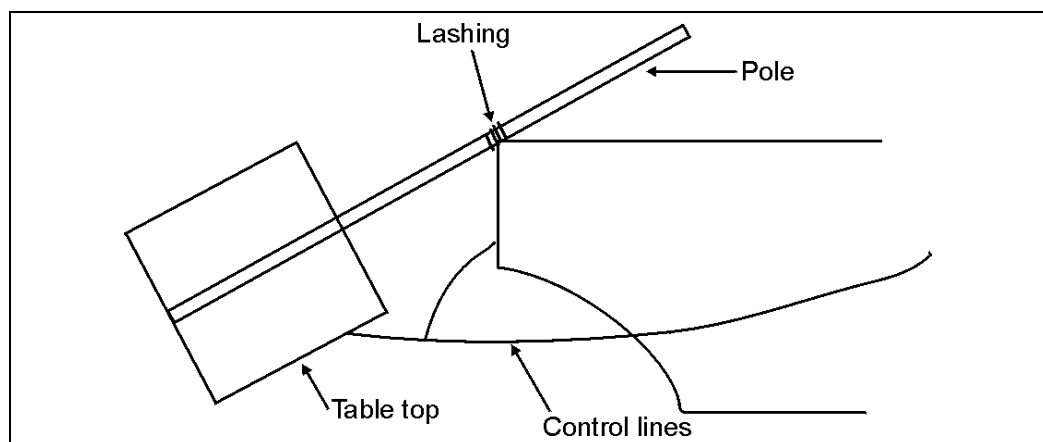

Figure 2.4 Jury Rudder

Figure 2.4 shows a jury rudder made by using a table top and pole. The pole is lashed to the stern of the vessel. The table top is connected to two steering lines. By pulling on the appropriate steering line, you can make the jury rudder turn in the desired direction.

3. PERSON OVERBOARD

If a person falls overboard, you should take the following actions immediately.

- Shout "Person Overboard" or similar words.
- Put the steering wheel hard over to the side on which the person fell. This action will swing the propeller clear of the person.
- Throw a life buoy close to and upwind of the person.
- Try to keep the person in sight while the vessel is going around.
- Perform a Williamson Turn to come back to the original course.

4. DISTRESS PROCEDURE

The master of a vessel at sea, on receiving a distress signal from another vessel, aircraft or survival craft, is bound to proceed with all speed to the assistance of persons in distress.

On a small vessel, a distress signal is likely to be observed visually or received on the radio. The distress call consists of the spoken word "MAYDAY" followed by the distress message. Distress signals are given in the International Regulations for Preventing Collisions at Sea which you will learn in section 4 of this learner's guide.

The obligation to proceed to the assistance of persons in distress is not absolute. Under certain circumstances, you may be relieved of this obligation. Examples are :

- When your own vessel is likely to be put in danger.
- When you have been informed by the vessel in distress, another vessel, or the marine authority that your assistance is no longer required.
- When you consider it unreasonable or unnecessary to do so.

When you receive a distress signal on the radio, you should wait about 30 seconds before replying to the call. This delay is for a coast radio station to respond first.

If you sight a visual distress signal, you should proceed immediately towards the distressed persons, informing the nearest coast radio

station or marine authority and ships nearby. Follow whatever instructions are given by the coast radio station or the marine authority.

It may happen that upon arrival at the scene of distress, you are unable to locate the survivors or you are requested to carry out a search for survivors by the coast radio station. Two types of search patterns are particularly suitable for carrying out a search in a systematic manner. These are the "Sector Search" pattern and the "Expanding Square" search pattern.

5. STABILITY

The stability of a vessel is defined as its ability to return to the upright position when heeled by an external force such as wind or waves.

The readiness with which a vessel returns to the upright position is a measure of the vessel's stability. If the vessel returns quickly to the upright position, we can say that it has large stability. If it is sluggish in returning to the upright position, the vessel has small stability. And, an unstable vessel will not return to the upright position at all. In fact, it may heel even further and possibly capsize.

The two major factors which affect stability are :

- freeboard; and
- the position of the centre of gravity of the vessel.

5.1 Freeboard

Freeboard is the vertical distance from the waterline to the vessel's main deck. Main deck is usually the lowest deck exposed to sea and weather which has permanent means of closing all openings.

Draft (Draught) is the vertical distance between the waterline and the lowest point of the hull, usually the keel.

Figure 2.8 shows the relationship between freeboard and draft. A vessel's freeboard and draft depend upon the amount of weight being carried by the vessel. If some weight was loaded on to a vessel, its draft would increase and its freeboard would decrease. This is shown in figure 2.8.

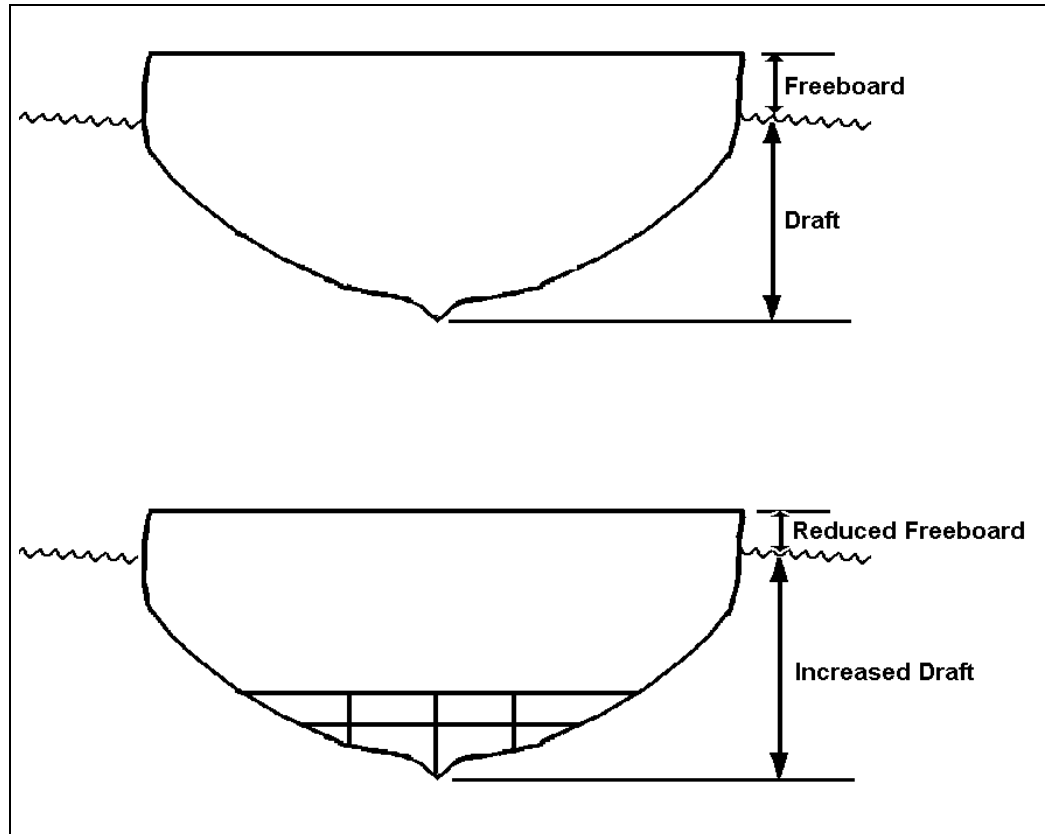

Figure 2.8 Freeboard and draft

Freeboard affects the angle of heel at which the deck edge immerses in water. If the freeboard is large, the vessel will have to roll much further before the deck edge touches the water. The stability of a vessel starts to reduce once the deck edge is immersed in water. Therefore it is vital that the vessel should have adequate freeboard at all times. In other words, the vessel should never be overloaded.

The freeboard at one of the vessel can also be reduced when the vessel is trimmed. This is shown in the following figure.

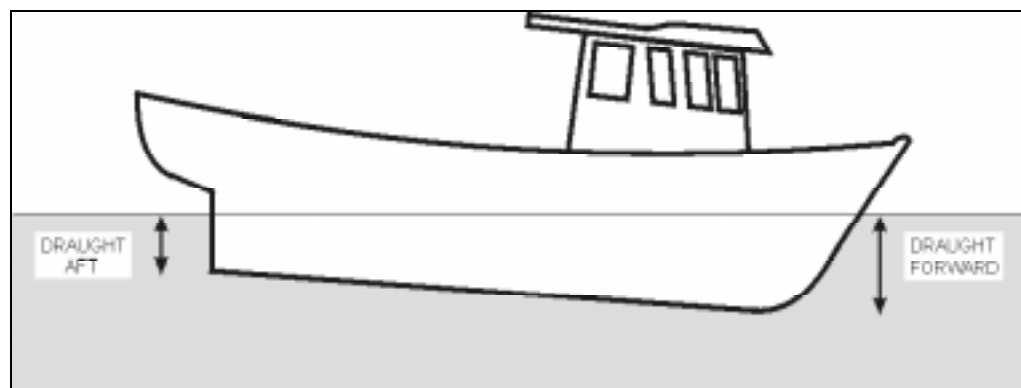

Figure 2.9 Trim by the bow

Note from figure 2.9 that the vessel's freeboard at the forward end is smaller than the freeboard at the aft end. Therefore, in order to have an adequate freeboard, it is important that the vessel's trim should be as small as possible. An even trim can be maintained if weights such as cargo, passengers, fuel etc are distributed evenly on the vessel and not concentrated at one end.

5.2 Centre of Gravity

The *centre of gravity* of a vessel is the point through which the whole weight of the vessel acts downwards. Its position depends upon the distribution of weights on the vessel.

If we were to load weights high up on a vessel, the centre of gravity will move up. If we were to load weights low down on the vessel, the centre of gravity will move down. This is shown in figures 2.10 and 2.11 where, 'G' is the position of centre of gravity.

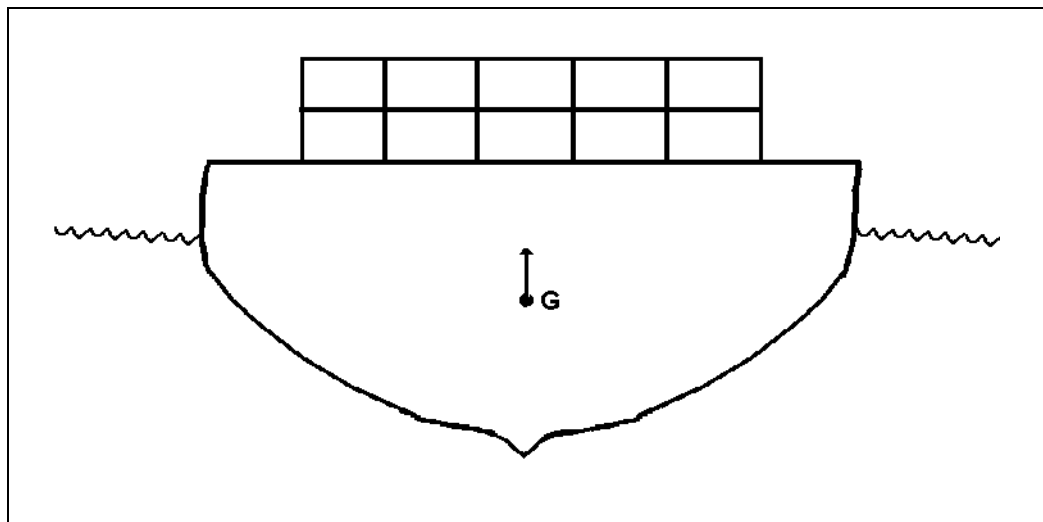

Figure 2.10 G moves up when weights are loaded high up

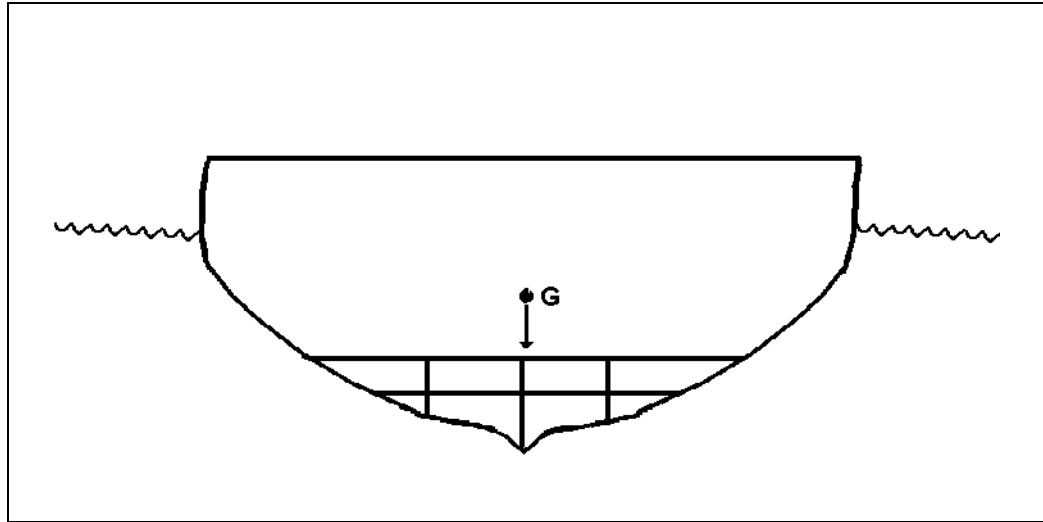

Figure 2.11 G moves down when weights are loaded low

The vessel's stability is improved when the centre of gravity is low.

The vessel's stability is decreased when the centre of gravity is high.

Therefore you should try to keep weights low down on the vessel. Note however, that an excess of stability can result in a jerky, uncomfortable motion of the vessel in a seaway, and create large stresses in the vessel's structure.

5.3 Free Surface Effect

When a vessel has partly filled tanks, the liquid surfaces are free to move around when the vessel rolls. The effect of these free surfaces is as if the centre of gravity of the vessel is raised. This effect is known as Free Surface Effect.

In other words, free surface effect reduces a vessel's stability.

It is not just the freely moving liquids in tanks that can cause this effect. Water in the bilges or water trapped on the deck will have a similar effect. Cargo such as fish which is free to move around in a fish hold will reduce the stability in a similar manner.

At the design stage of the vessel, tanks that extend from one side of the vessel to the other side, are usually subdivided longitudinally to reduce this effect.

As far as the operation of the vessel is concerned, you can reduce free surface effect by :

- Keeping tanks full or empty as far as possible.

- Keeping the bilges dry.
- Keeping scuppers and freeing ports open on deck so that any water shipped in a seaway, can drain freely.

5.4 Capsizing

In section 1 of this learner's guide, you had learned that a vessel may capsize under the influence of wave action. From the point of view of stability, a vessel may capsize due to the following reasons.

1. If the vessel's centre of gravity is very high, it may not have sufficient stability to return to the upright position when heeled by wave action.
2. Free surface effect may cause the vessel to become unstable.
3. The vessel may have inadequate freeboard. In addition to the reduction in stability when the deck edge immerses in water, the vessel may also start shipping water on deck. If the scuppers and freeing ports are not kept open, the water may get trapped on deck. This will add extra weight high up on the vessel and its centre of gravity will move up. In addition, stability will be decreased by free surface effect. The situation may become worse if watertight openings on deck are left open and water enters the hull.
4. If the waves create a waterline as shown in figure 2.12, the vessel will suffer a great loss of stability. In some cases, the loss of stability may be enough to capsize the vessel. This situation is particularly dangerous in following seas because the wave crest may remain near the middle of the vessel for a long time. In such cases you should immediately alter course and/or change speed.

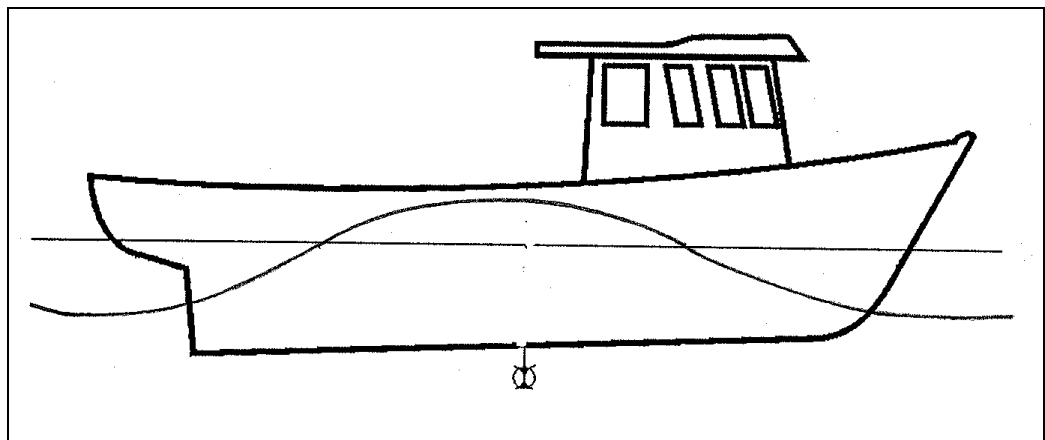

Figure 2.12 Vessel riding a wave crest

Section 3

Marine Legislation Procedures

1. CERTIFICATE REQUIREMENTS

Every country has its own laws, rules and regulations, which govern all aspects of vessel operations. These are enforced through appropriate marine authorities. The primary motive behind these regulations is the concern for the safety of life and environment.

Marine authorities are given the task of ensuring that :

- a vessel is built according to strict standards of workmanship and materials;
- the vessel is designed to operate in a stable condition;
- the vessel is properly equipped and manned for its intended operation;
- the vessel continues to operate in a safe manner through out its life.

In order to ensure that a vessel complies with the requirements stated above, marine authorities generally:

- carry out inspections and surveys when the vessel is newly built;
- issue the vessel with certificates that prove that the vessel is complying with the applicable regulations; and
- periodically inspect and survey the vessel to ensure that the conditions under which the certificates were issued, continue to be maintained on the vessel.

As master of a vessel, you need to know what certificates your vessel is required to have and what conditions must be satisfied to maintain the validity of these certificates. Certificates usually have an expiry date and you may be in breach of law if you operate a vessel with expired certificates.

2. POLLUTION PREVENTION

Marine pollution is strictly controlled by an international convention known as MARPOL 73/78 or simply MARPOL.

MARPOL specifies WHEN, WHERE and HOW a pollutant can or cannot be discharged into the sea. It also regulates the arrangements for disposal of marine pollutants, recording and reporting procedures, and criteria for design, construction, equipment and operation of ships.

Examples of marine pollutants include :

Oil - oil mixtures, gasolines, jet fuels, etc.

Noxious liquid substances - mainly chemicals including acids, alcohols, etc. Also citric juice, glycerin, milk, molasses, wine, etc.

Harmful substances in packed form- includes freight containers, portable tanks, road and rail tank wagons, etc.

Sewage - wastes from toilets, drainage from spaces containing live animals, etc.

Garbage - plastic bags, synthetic ropes, food wastes, paper products, glass, metal, crockery, packaging material, synthetic fishing nets, etc.

2.1 Discharge of Oil

The discharge of oil or oily substances from vessels is prohibited unless strict conditions are met. In order to satisfy these conditions, vessels must be fitted with special equipment and installations, as required by the regulations.

It is unlikely that your vessel will be fitted with special equipment. However, under MARPOL, a vessel of less than 400 gross tonnage (other than an oil tanker) need only be capable of storing oil residues on board, and discharging them to reception facilities ashore.

Therefore, you should never discharge any oil or oily substance into the sea. Store all oily residues in a suitable container or tank on board and discharge them to reception facilities ashore.

2.2 Disposal of Garbage

The disposal of plastics into the sea is totally prohibited in any location. Plastic items are not biodegradable and therefore persist in the environment. Some plastics will crumble eventually into small fragments and finally into fine powder particles which can transfer toxins through the ocean.

Plastic materials used at sea include synthetic materials such as

- trawl and fishing nets
- synthetic rope
- plastic sheeting
- “six pack holders”
- bait baskets

- electrical and electronic components
- fibreglass
- paints
- floats
- strapping bands
- plastic "ice" bags
- disposable eating utensils etc.

Many marine animals die as a result of becoming entangled in discarded plastic packing straps, netting, nylon rope, plastic bags and sheeting, bait holders and foam items. Plastic fragments may be mistaken for food or ingested accidentally.

Garbage can also be costly for the shipping and fishing industry. Rope and plastic material may get caught in propeller shafts or block water intakes causing major damage, expensive repairs and loss of income while vessels are repaired.

The regulations state that:

- (1) Disposal of any plastic garbage into the sea, including synthetic fishing nets, rope, plastic bags, is prohibited.
- (2) Food waste and all other garbage (including paper products, rags, glass, metal, bottles and crockery) cannot be discharged within 12 nm of land unless they have first been passed through a grinder or processor. Even then, the minimum distance from land beyond which disposal is permitted is set at three (3) miles.
- (3) Dunnage lining and packing materials which float can only be disposed of at sea when more than 25 nautical miles from land.

Unlike larger vessels which may be fitted with incinerators, small craft operators need to carefully plan the taking aboard of potential garbage and on-board generation of garbage. The following factors should be considered to reduce the amount of garbage onboard and the possibility of fines.

- Avoid using disposable products. For example - use crockery instead of paper cups and plates.
- Compact or crush your garbage so that it will take up less space on the vessel.
- Select provisions that are packed in or made of materials other than disposable plastic.

Section 4

Weather Watch Keeping Procedures

Important

The weather information contained in this section is an overview of weather patterns in the Pacific Island Countries region.

It is important to remember that local weather conditions and patterns can vary enormously throughout the region.

Trainers and mariners involved in the Class 6 Master/Engineer course must make sure that emphasis is placed on understanding the weather that is experienced in their own area.

1. COMMON TERMS

Isobar

Is a line on a weather map that joins places having the same atmospheric pressure. Used to determine the direction and strength of the wind. The closer the isobars are together the stronger the winds will be.

Tropical Cyclone or Tropical Revolving Storm

An area of intense low pressure which may form over tropical waters, usually in the summer months, in the Southern Hemisphere.

Trade Winds

In the South Pacific, between Latitudes 10° and 30° (approx.) South, this refers to the South-Easterly winds which are the prevailing winds.

Wind Direction

The wind blows anti-clockwise around a 'high', or anticyclone, in the Southern Hemisphere.

It blows in a clockwise direction around a 'low', or cyclone, in the Southern Hemisphere.

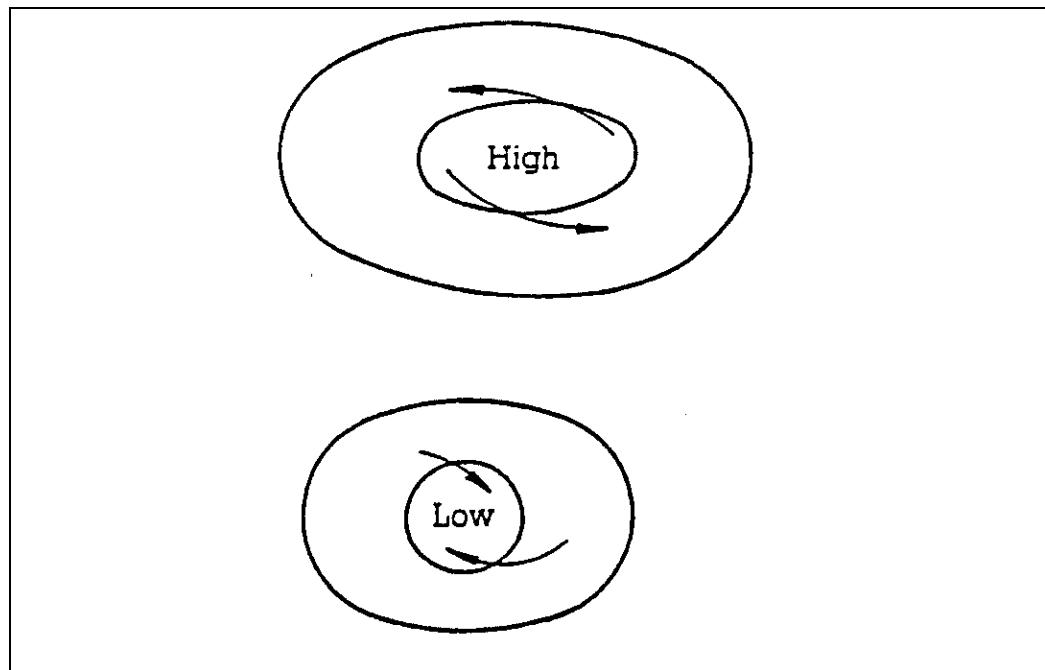

Figure 4.3 Wind Directions in Areas of High and Low Pressures

2. WEATHER REPORTS

Weather information can be sourced from any of the following:

Commercial radio
Television
Newspapers
Weather fax
Telephone
Coast radio stations - HF 4125-6215,
Air-Sea Rescue
Other vessels
Own observations

Weather information is transmitted via Maritime Coast Radio Stations on regular weather and traffic schedules. Mariners should make themselves familiar with the frequencies used by these stations, and the times of transmission.

Local Weather Reports

These are issued as follows:

- American Samoa (Pago Pago) for Samoa and Tokelau
- Fiji Islands (Fiji broadcasting Commission) (Storm Warnings)
- Fiji Islands (Suva) for gale warnings
- Kiribati (Tarawa)
- Marshall islands (Majuro)
- Tonga islands (Nuku'alofa) for Tonga and Niue
- Tuvalu (Funafuti)

Pacific General Weather Pattern

For most of the year, the Northeast trade winds of the Northern Hemisphere and the Southeast trade winds of the Southern Hemisphere blow with considerable constancy. In the West of the area and within about 8 degrees of the Equator, winds with a west component are liable to occur between November and March.

South of 20 degrees South, winds usually become more variable in the southern winter as depressions move past in the higher S Latitudes.

3. INTERPRETING WEATHER REPORTS

3.1 The Synoptic Chart

The Synoptic Chart provides an indication of the weather in one's own area. The Chart shows the arrangement of isobars around the areas of high and low pressures. The direction of the isobars will indicate the likely direction of the wind. The bunching or separation of the isobars will point to the strength of the wind, eg:

Close isobars = strong winds

Widely-separated isobars = light winds

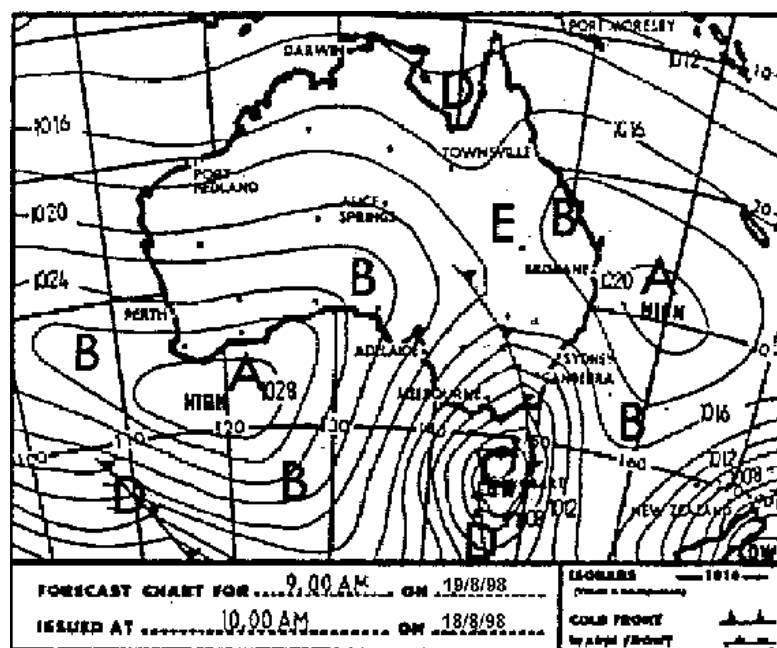

Figure 4.4 Synoptic Chart

3.2 Useful Meteorological Instruments

The most important observations used in weather forecasting are obtained from the BAROMETER, and involve:

- (a) the atmospheric pressure and
- (b) its rate of change

3.2.1 The Aneroid Barometer

This is illustrated in Fig. 4.6 below. In its simplest form, it comprises a metal “bellows”, the contraction and expansion of which are amplified through a system of levers, and thence to a pointer indicating pressure on a hectopascal scale. It responds quickly to small changes in pressure.

An aneroid should be located where it is not liable to shocks or temperature changes, and out of direct sunlight. Tap gently before reading.

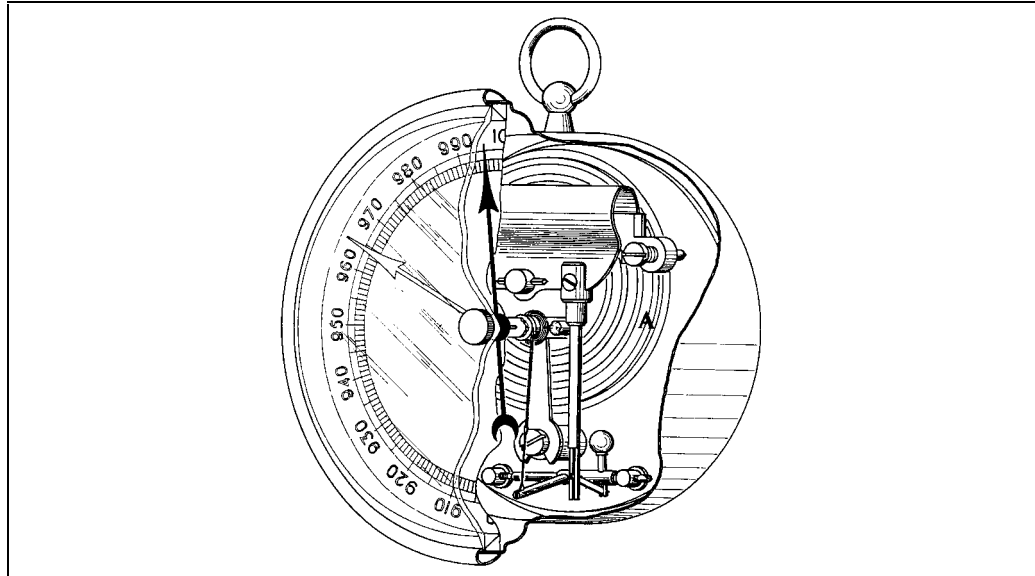

Figure 4.6 Aneroid barometer

4. TROPICAL REVOLVING STORMS

The weather of the tropics is typically monotonous, steady and predictable, with an even temperature regime. This is particularly so in tropical oceanic areas. However, *the tropical revolving storm* (TRS), a most violent weather phenomena, is also generated within the tropics.

4.1 Development of the Tropical Revolving Storm

TRS's typically occur in tropical oceanic regions, in late summer or autumn. At this time, the sun has been overhead in its respective hemisphere for the maximum time, with sea temperatures at or near their annual maximum.

4.2 Movement of a Tropical Revolving Storm

The figure on the next page shows the typical path of a TRS in the Southern Hemisphere, and optional 'escape' routes for vessels within the storm area.

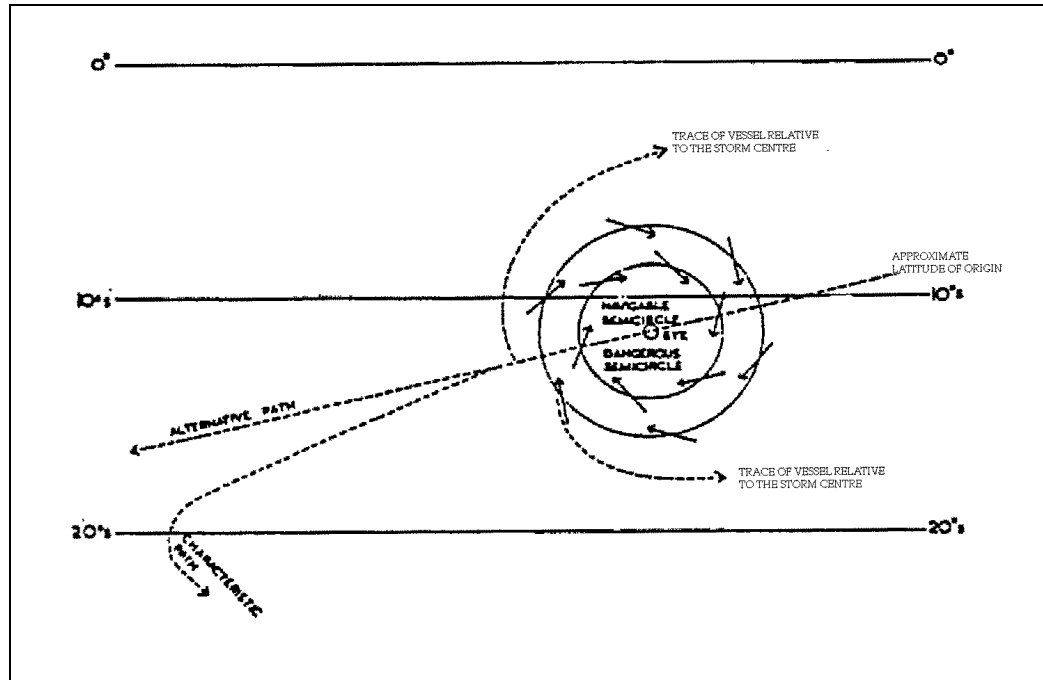

Figure 4.8 Typical path of TRS in Southern Hemisphere

They generally move westwards, then pole wards, then recurve easterly into higher latitudes. If they tend to proceed over land, they lose intensity and degenerate into rain depressions, although they may regenerate if they move over warm sea again.

If they proceed to higher latitudes into areas of low sea temperature, they decline into low-pressure centres

4.3 Parts of a Tropical Revolving Storm

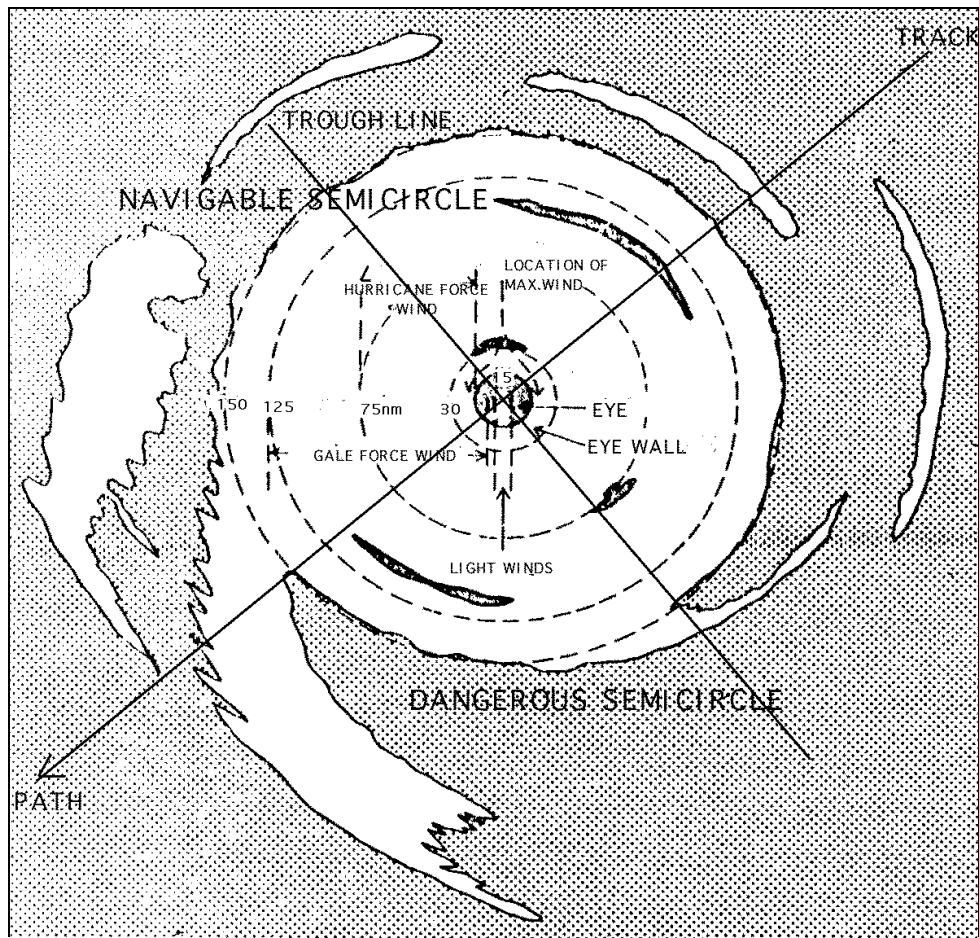

Figure 4.9 TRS

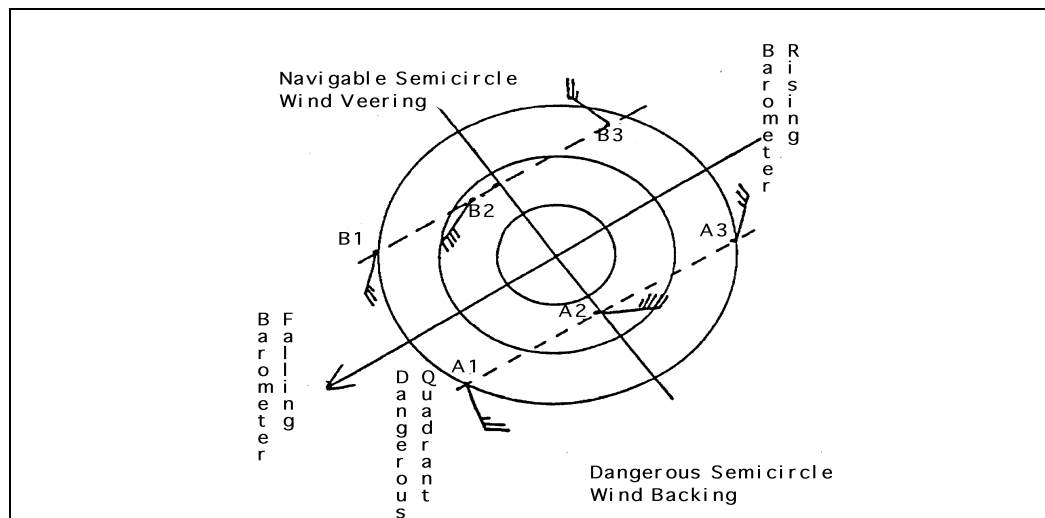

Figure 4.10. - Diagrammatic representation of 'Semicircles'

4.4 Action to Take When Navigating Near a Tropical Revolving Storm

(The scenario is confined to consideration of a Southern Hemisphere storm.)

1. *Never get caught in or near a Tropical Revolving Storm*

A small boat should listen to weather forecasts and have taken observations so as to head to port well before a TRS is near them. In the event that they do get caught at sea near a TRS they should take the following precautions and steer away from the centre of the TRS and its predicted path

2. *Determining the bearing of the storm centre.*

The bearing of the centre will be around 135° to the left of the wind when the barometer begins to fall. When it has fallen 10 hPa, the centre will be about 112.5° to the left of the wind. When it has fallen 20 hPa, the centre will be about 90° to the left of the wind.

3. *Estimating the distance to the storm centre.*

This is more difficult, since the intensity of storms varies. As a rule of thumb, if the corrected barometer is 5 hPa below normal, the centre of the storm is probably within 200 miles. If the wind is above 34 - 40 knots the centre is probably within 100 miles.

4.5 Warning Signs of Bad Weather

1. *Coast radio stations* will be issuing frequent and regular warnings, including the best information available of the position of the centre and its expected movement.

2. *Barometric Pressure:* A definite, steady fall in the barometric pressure. Be alert to the possibility of bad weather or a TRS if the corrected pressure is more than 3 hPa below normal.

If the pressure falls more than 5 hPa below normal, there is probably a storm within 200 miles. When checking the barometer to see if it is below "normal", it is essential to take into account the diurnal variation. A sudden steep fall in pressure will indicate the storm is within 100 miles. Earlier warning signs are:

3. *Appreciable change* in the direction and strength of the wind.

4. *Unusual clarity* of the atmosphere.

5. Extensive *high cirrus* cloud, pointing towards the storm centre, and reflecting lurid colouring at sunrise and sunset.

6. In the open sea, *swell* from the direction of the storm centre.

7. *Unusual heat* a few days before

Section 5

Watchkeeping

1. THE COLREGS

“The International Regulations For the Prevention Of Collisions At Sea (1972)” will be abbreviated to the word “COLREGS” in this Learner’s Guide.

1.1 Application of the COLREGS

It is important for candidates for Masters’ certificates to appreciate that safe conduct of their vessels in relation to the Collision Regulations involves 3 processes of application:

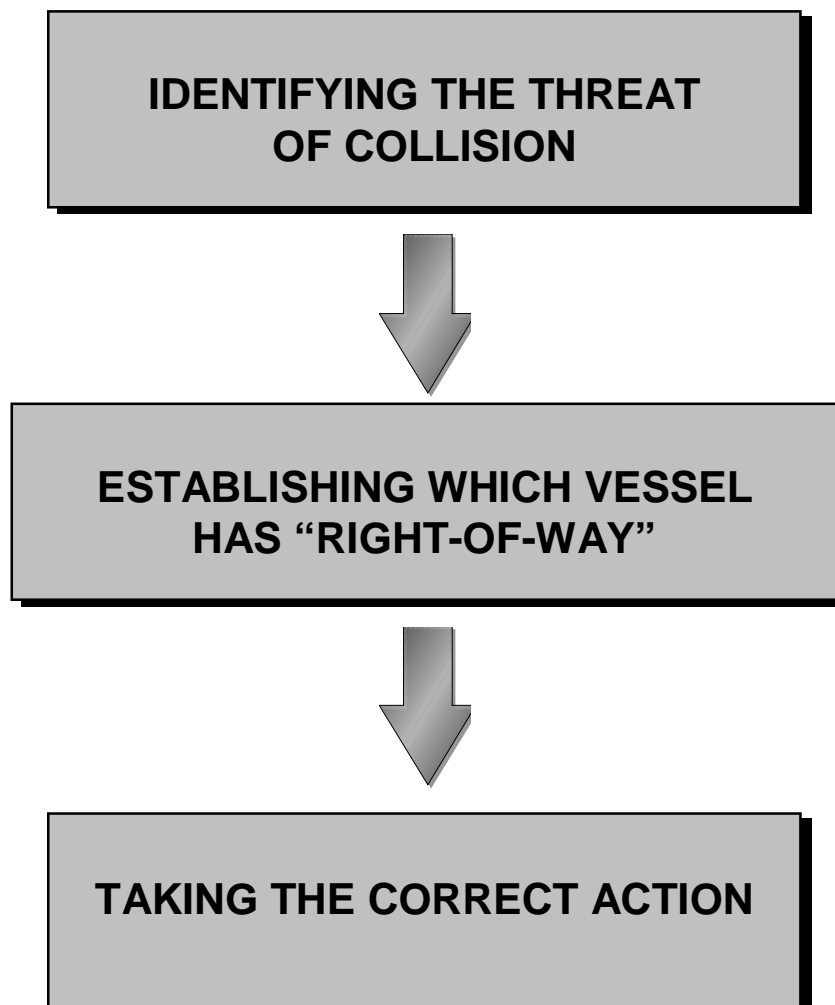

Students are encouraged, therefore, to recognise that each Rule pertains to at least one of these 3 processes.

1.2 COLREGS Part B - Steering and Sailing Rules

Part B of the Rules is concerned with the action that a boat should take when there appears to be the likelihood of a close quarters situation developing with another vessel or vessels.

You should make sure that you fully understand the following Rules:

- Rule 5 : Look-out
- Rule 6 : Safe Speed
- Rule 7 : Risk Of Collision
- Rule 8 : Action to Avoid Collision
- Rule 13 : Overtaking
- Rule 14 : Head-On Situation
- Rule 15 : Crossing Situation
- Rule 16 : Action by Give-Way vessel
- Rule 17 : Action by Stand-On vessel

1.2.1 Rule 5 : Lookout

Keep a look-out by:

- Sight
- Hearing
- All available means (i.e. a radar if there is one on the vessel, and the set is operational)

1.2.2 Rule 6 : Safe Speed

Speed at which avoiding action can be taken, and the vessel stopped.

- state of visibility
- traffic density (including fishing fleets)
- own vessel's manoeuvrability
- at night, backscatter from own and shore lights
- wind, sea, current and navigational hazards
- own draught

1.2.3 Rule 7 : Risk of Collision

- Use all means available to find out if risk of collision exists
- If in doubt, assume there *is* risk of collision
- Take *compass bearings* of approaching vessel to determine risk of collision

- Assume there is *still* risk of collision if such compass bearings either:
 - **change very slowly**
 - or
 - **change appreciably but the closing vessel is close or big**

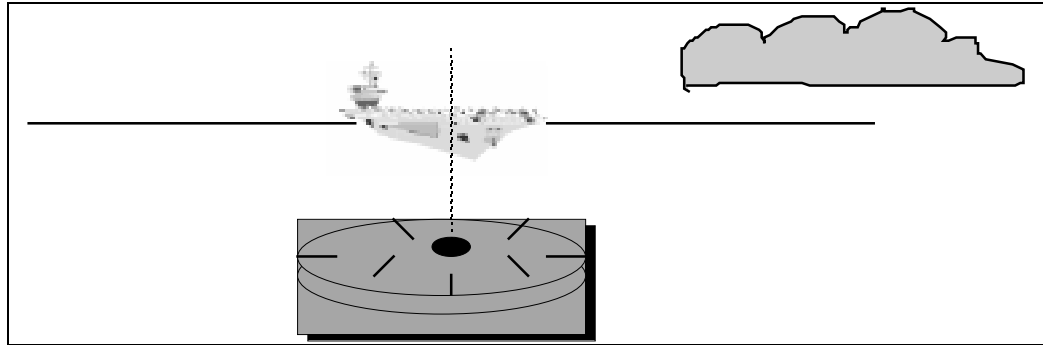

Figure 5.1 Compass bearing

1.2.4 Rule 8 : Action To avoid Collision

- Action should be *positive, early, and sound seamanship*
- Course/speed changes should be *obvious* to other vessel on radar/visually
- Do not use a succession of small alterations of course
- *Large change of course* is the preferential solution to avoid collision
- The avoiding action should ensure a *safe passing distance*
- Watch the other vessel *until finally past and clear*
- If unsure, *slow down, or go astern*
- Give plenty of early sea-room to vessels with *right-of-passage*
- A 'right-of-passage' vessel must still comply with Rules in a risk-of-collision situation

1.2.5 Rule 13 : Overtaking

- A vessel overtaking shall keep out of the way of the vessel being overtaken
- If in doubt whether if your vessel is the overtaking vessel, assume you are

1.2.6 Rule 14 : Head-on Situation

- When two vessels are meeting head on they should both alter course to starboard so as to avoid each other

1.2.7 Rule 15 : Crossing Situation

- When two vessels are crossing each other the vessel which has the other vessel on the starboard side shall give way
- In giving way the vessel should avoid crossing ahead of the other vessel

1.2.8 Rule 16 : Action by Give-way Vessel

This Rule emphasises the need for avoiding action to be early and substantial

1.2.9 Rule 17 : Action By Stand-On Vessel

- Must maintain course and speed
- Can only initiate avoiding action herself if it becomes apparent that other vessel is not complying with the Rules
- Such avoiding action by the right-of-way vessel should not involve turning to port to avoid a vessel on her port side
- Proceed at “safe speed” (as previously defined)

1.3 COLREGS Part C - Lights and Shapes

Lights and shapes serve to draw a picture of what sort of operation the other vessel is engaged in.

Similarly, the lights and shapes displayed by one's own vessel also tell a story to other ships in the area about what is the nature of your business, what operation you are engaged in.

At the Master 6 level, students should know the lights and shapes required to be displayed by small vessels, and be able to recognise certain other types of lights that vessels display at night.

These can be summarised as follows:

1. The lights of a power-driven vessel under 50 metres (Rule 23 (a))
2. The lights of a power-driven vessel under 12 metres (Rule 23 (c)(I))
3. The lights of a power-driven vessel under 7 metres (Rule 23 (c)(ii))
4. The lights of a sailing vessel (Rule 25 (a))
5. The lights of a sailing vessel under 20 metres (Rule 25 (b))
6. The lights and day shapes for a vessel engaged in fishing (Rule 26 (c))
7. The lights and day shapes for a vessel not under command (Rule 27 (a))
8. Lights and day shapes for a vessel at anchor (Rule 30 (a), (b) and (c))

Students will need to get access to coloured drawings of these lights and shapes so as to be able to learn them thoroughly and identify them easily.

1.4 Annex 4: Distress Signals

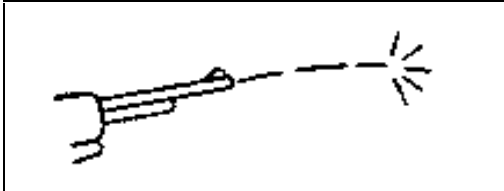
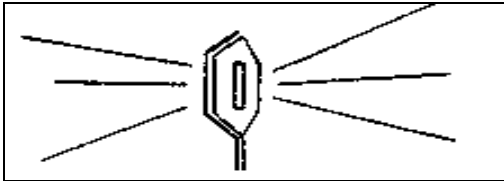
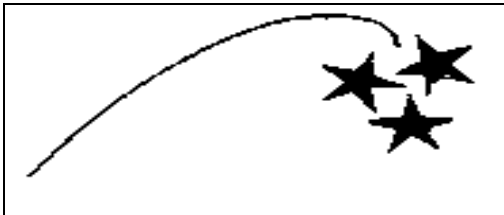
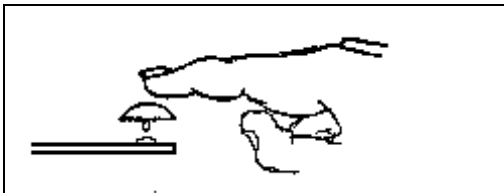
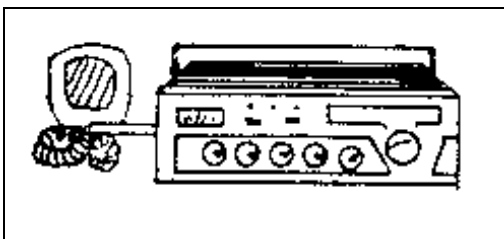
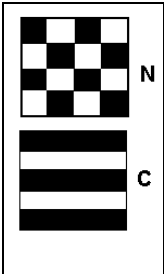
<u>SIGNAL</u>	<u>MEANING</u>
	<p>A gun or other explosive signal fired at intervals of about a minute.</p>
	<p>A continuous sounding with a fog-signalling apparatus</p>
	<p>Rockets or shells throwing red stars fired one at a time at short intervals.</p>
	<p>A signal made by radio, telegraphy or by any other signalling method consisting of the group (SOS) in the morse code.</p>
	<p>A signal sent by radio telephony consisting of the spoken word "MAYDAY".</p>
	<p>The International Code signal of distress indicated by the two signal flags "N" and "C" flown one atop the other in the manner shown.</p>

(See International Code of Signals for correct colouring)

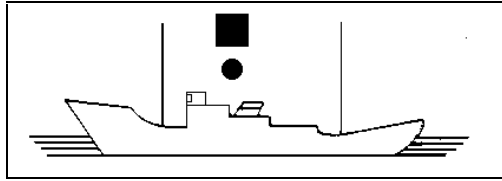

A signal consisting of a square flag having above or below it a ball or anything resembling a ball

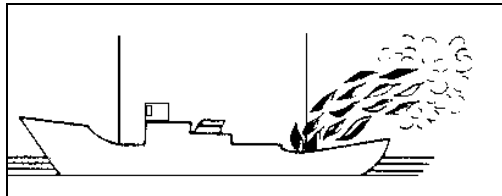

Flames on the vessel (as from a burning tar barrel, oil barrel, etc).

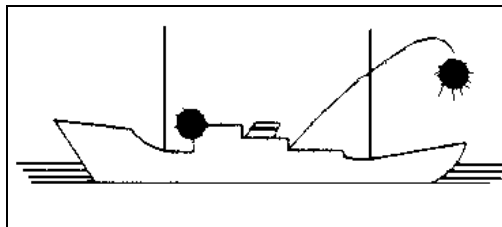

A "red" parachute flare or a hand held flare.

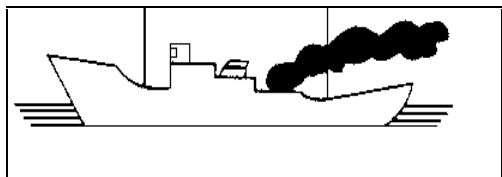

A smoke signal giving off orange coloured smoke

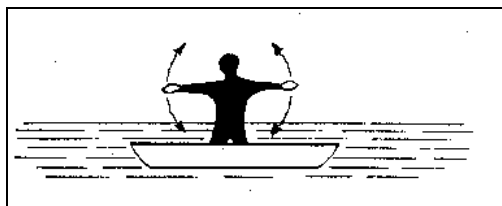

A person slowly and repeatedly raising and lowering arms outstretched to each side.

Section 6

Vessel Construction

1. DESIGN FEATURES

A vessel's design is influenced by the following factors:

- Nature of service
- Area of operation
- Seaworthiness and stability
- Stresses form loading and external factors
- Survey requirements
- Personnel safety
- Construction materials
- Commercial requirements

1.1 Hull

The hull is the main bulk and watertight body of any vessel. In its basic form, it consists of a bow, a stern and a keel.

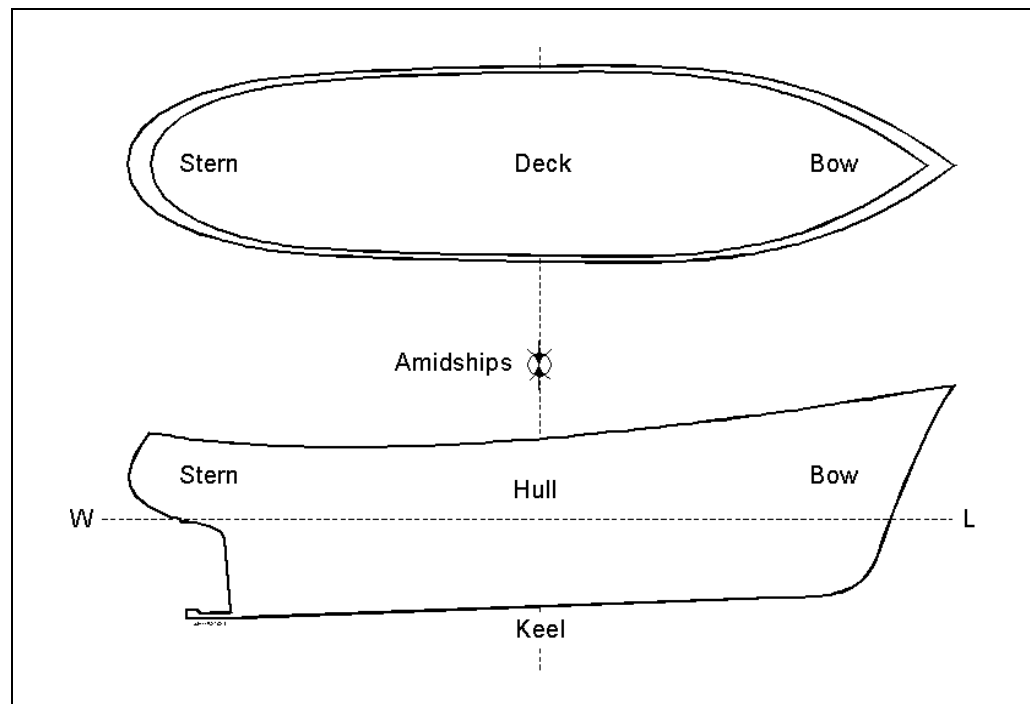

Fig. 6.1 Basic components of a vessel's hull.

In nearly all types of vessel construction, (*rafts and dugout canoes being exceptions*), the hull consists of a watertight shell permanently attached to a stiffening and strengthening framework.

All vessels consisting of a single hull, are referred to as mono-hulls. Vessel designs incorporating more than one hull are referred to as multi-hulls. Outrigger canoes, Catamarans and Trimarans are all examples of multi-hull vessels.

1.1.1 Hull Shape

The final hull shape of a vessel is the direct result of careful consideration between the vessel designer and its owner, taking into account the requirements of the Marine Authorities regarding safety and stability, its field of operation and its means of propulsion. There are basically two distinct hull shapes, and they are:

- Conventional Hulls (Round bilge vessels)
- Chine Hulls

If a vessel's bottom section turns to meet the topsides in a curve, it is referred to as a round bilge vessel or conventional hull.

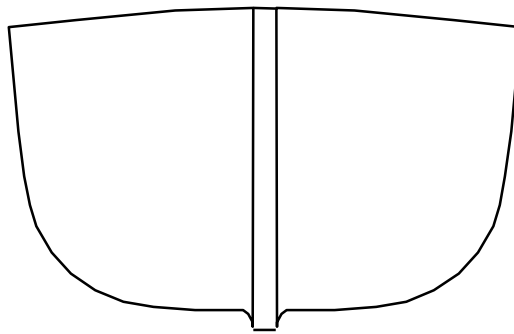

Figure 6.2 Conventional round bilge hull

Two examples of chine hulls are shown in figure 6.3.

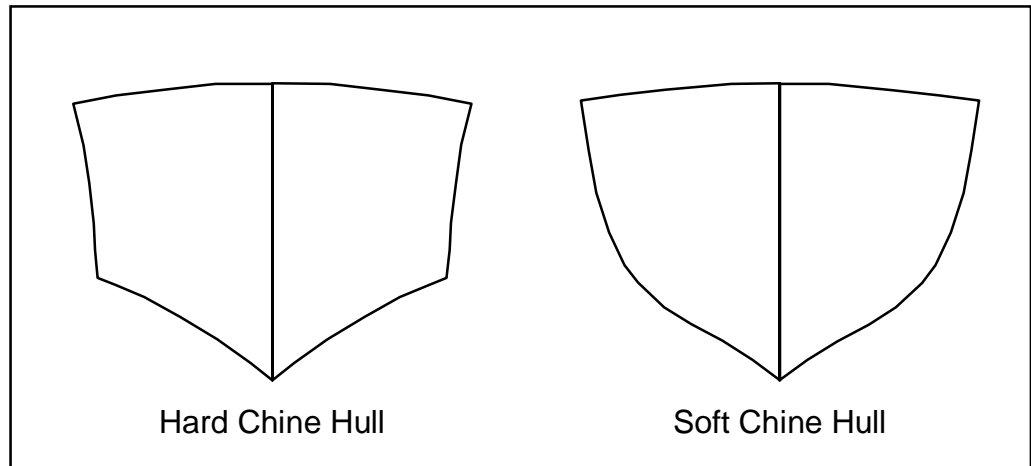

Figure 6.3 Chine hulls

The main hull measurements are shown in figure 6.4. Draft and freeboard were defined in section 2 of this learner's guide. Length at Waterline and Length Overall are self explanatory terms.

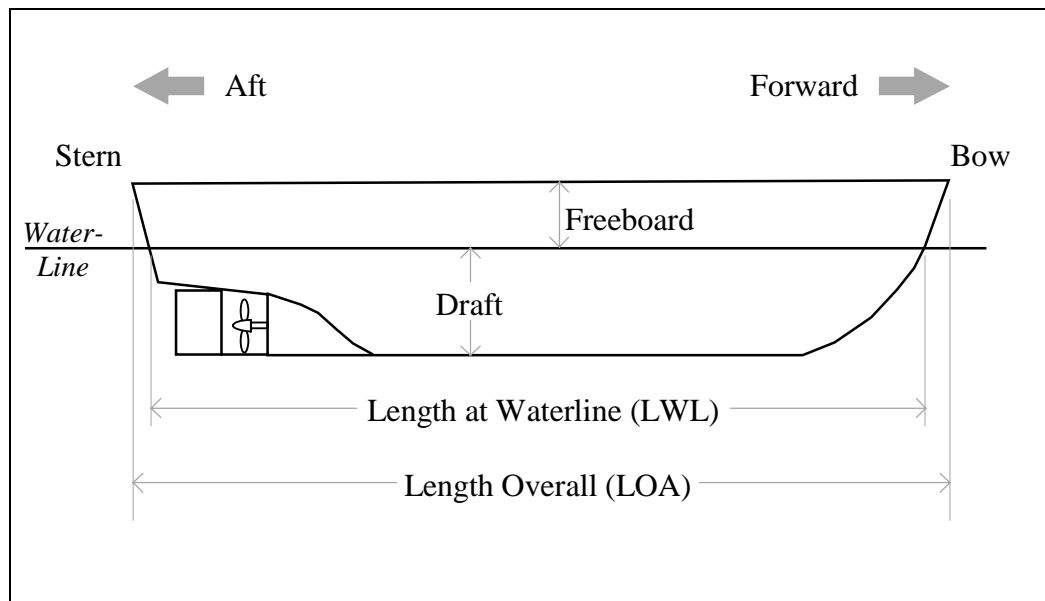

Figure 6.4 Main hull measurements

2. CONSTRUCTION MATERIALS

Vessels are built from a number of materials, each with distinct advantages and disadvantages.

The main types of materials used in hull construction are:

1. Aluminium
2. Steel
3. Timber
4. Fibreglass Reinforced Plastic (F.R.P.)
5. Ferro-Cement

2.1 Aluminium

Advantages:

1. Lightweight
2. Does not rust - almost maintenance free
3. Easy to work

Disadvantages:

1. Expensive
2. Comparatively easily damaged
3. Low melting point - poor fire resistance
4. Corrodes rapidly in contact with other metals such as steel, copper, bronze etc.

2.2 Steel

Advantages:

1. Inexpensive
2. Comparatively easy to build
3. Not easily damaged
4. Good fire resistance

Disadvantages:

1. Corrodes readily
2. Heavy
3. Not easy to work
4. Very magnetic. Affects the compass.

2.3 Timber

Advantages:

1. Light
2. Easy to work
3. Corrosion resistant
4. Not easily damaged

Disadvantages:

1. Expensive
2. Requires skilled construction
3. Requires careful maintenance to prevent rot
4. Burns easily

2.4 Fibre Reinforced Plastic

Advantages:

1. Corrosion free
2. One piece hull, no seams below deck level
3. Light to medium weight
4. Comparatively easily repaired
5. Inexpensive - especially if part of a mass produced design

Disadvantages:

1. Easily damaged
2. Poor fire resistance
3. Skilled construction required
4. Osmosis

2.5 Ferro Cement

Advantages:

1. Inexpensive
2. One piece hull, no seams
3. Fire resistant
4. Easily repaired

Disadvantages:

1. Chips easily
2. Low impact resistance
3. Heavy
4. Magnetic - Affects the compass

3. WATERTIGHT INTEGRITY

A vessel is constructed in a manner that ensures that the water in which the vessel floats does not enter the hull and cause progressive flooding. This characteristic of a vessel is known as its watertight integrity.

The shell of any vessel, regardless of the material used to construct it, has as its primary purpose, the task of keeping the interior of the vessel free from the water it floats in. In all types of vessel construction, a structural framework is built to provide strength and this, when combined with the external covering, forms the hull.

In steel and aluminium vessels, the hull is made watertight by welding individual plates together along their edges and to the framework. FRP and ferro cement hulls are continuous with no joints and are inherently watertight, as is their deck to hull connection. Vessels constructed of timber are not normally watertight but rely on seepage of water to swell their planking and thus make them watertight.

Vessels are however, prone to stresses caused by a number of operation factors that could cause the loss of watertight integrity. A simple collision or grounding could open a welded seam on the hull of a steel vessel or loss of caulking from a wooden vessel which could be disastrous.

There are many different openings incorporated into the construction of a vessel's hull. Inlet ports are necessary to take on board cooling water for a vessel's machinery, or ballast water for stability. Discharge ports are needed to remove ballast or excess water and portholes are required for natural ventilation and light.

There are many openings in the weather deck of a vessel. These include access hatchways, watertight doors, ventilators, airpipes etc.

Hatchways must be constructed with a raised coaming to resist the amount of water that could enter the vessel should a wave wash over the deck while the hatch is open. The height of the coaming is under the control of regulations and varies according to the vessel's length. The hatch cover and coaming are so designed that when the hatch is closed, a watertight seal is created between the hatch and the coaming edge.

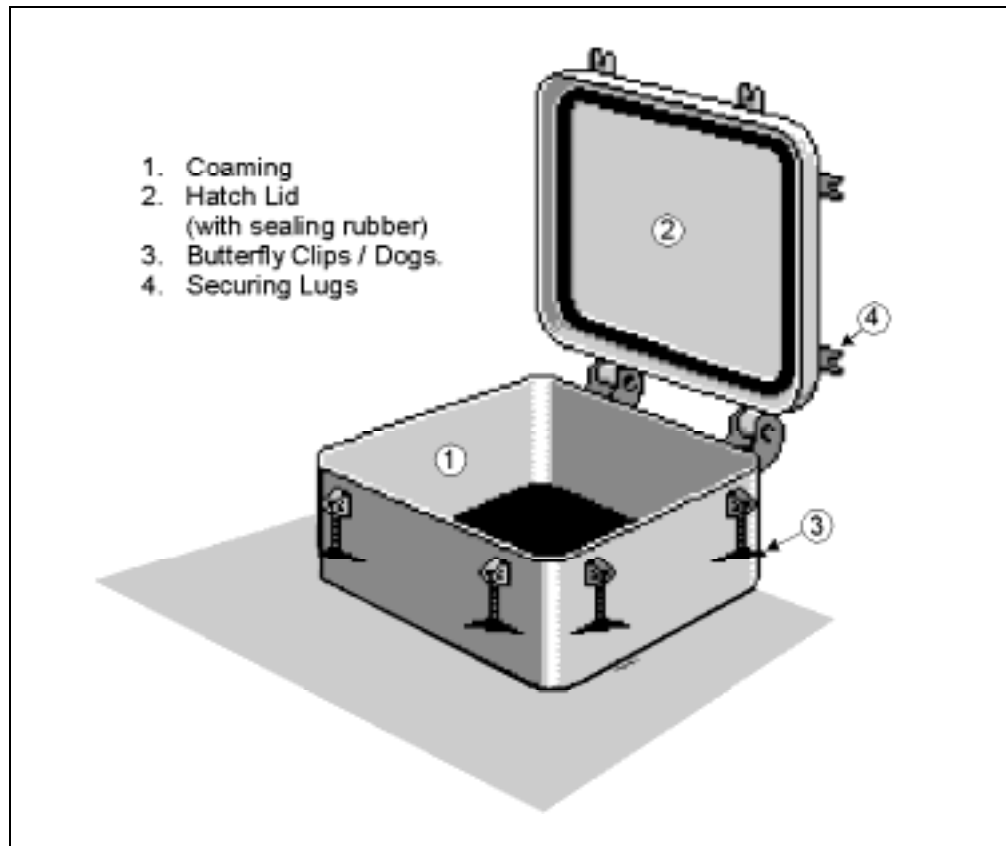

Fig. 6.6 Watertight Access Hatchway.

Most commercial vessels are required to have bulkheads that divide the hull into separate compartments. The purpose of these bulkheads is to contain flooding in any one compartment if the hull's watertight integrity is breached.

Openings may be necessary in watertight bulkheads to allow the unrestricted passage of pipes or electrical cables and access or emergency doors may also be fitted. In all cases, special arrangements are made to ensure the watertight integrity of the bulkhead is maintained. All pipes or electrical conduits must be flanged to the bulkhead and not pass directly through it.

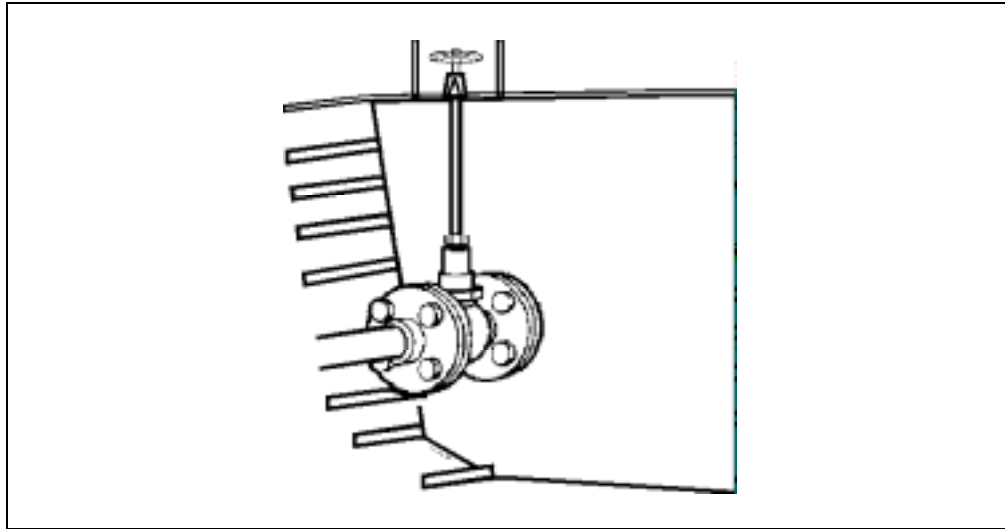

Fig. 6.7 Watertight Bulkhead.

3.1 Maintenance of Watertight Integrity

Watertight integrity can be breached through any activity or happening that allows water into any unwanted area or compartment of a vessel.

Typical examples include:

- Lack of maintenance to seals, screw threads and other locking devices.
- Damage caused by collision, grounding or heavy weather.
- Leaving hatches, doors, vents or portholes open.
- Blocked freeing ports or scuppers.
- Cracks along welds in metal vessels or the loss of caulking from planked seams in timber vessels.

An unnoticed open porthole or leaking hatch seal can, during moderate weather conditions, ship enough water into sections of your vessel's hull that could seriously effect its stability or handling ability. Gale force winds and heavy seas tests the watertight integrity of all vessels. All areas of your vessel that may threaten its watertight integrity should be checked and repaired before putting to sea.

The effects of loss of watertight integrity are many. Apart from the obvious danger that total loss of the vessel and possibly life may occur, excess or unwanted water inside your vessel will cause the following:

- Structural stresses that will shorten the vessel's useful life.

- Corrosion of internal structures and fasteners.
- Rot and decay of wooden sections.
- Loss of expensive machinery and equipment.
- Instability and poor handling characteristics.
- Poor health brought about by damp living conditions.

3.2 Safety procedures for maintaining Watertight Integrity

It is essential that you are thoroughly familiar with the locations and closing mechanisms of all openings on your vessel through which water may enter the hull. This way you will not neglect to check, maintain and test the efficiency of any of the closing arrangements.

It is a good practice to prepare for yourself a checklist of all items that could compromise your vessel's watertight integrity and check each of them regularly.

- Seals and gaskets on watertight bulkheads, doors and hatches should be checked periodically for cracks or hardness.
- Door and hatch seal rubbers should never be painted. Paint hardens soft rubber seals or gaskets and so renders them less effective and in some cases totally useless as a watertight seal.
- Check all hatches for watertightness.
- All watertight doors and portholes should be closed and secured when not in use.
- All deck freeing ports (scuppers) should be checked regularly to ensure they are not blocked by debris.

Section 7

Ropework

1. FIBRE ROPE

1.1 Synthetic fibre ropes

Synthetic or *man-made* fibre ropes are made from materials such as:

- Polyamide (PA) - commonly known as 'nylon'
- Polyester (PES) - commonly known as 'terylene' or 'dacron'
- Polypropylene (PP)
- Polyethylene (PE)

They have replaced natural fibre ropes in many areas mainly because of:

1. greater **strength** - allows a smaller rope to carry a much greater load.
2. **elasticity** (ability to stretch) - for greater shock absorption

Some synthetic materials **float** while others do not - this may be important when ropes are thrown to a person in the water, or as they may sink and tangle on the rudder or get caught around the propeller.

They also **melt** (being basically plastics) which can occur in situations such as heavy surging of the line on a drum-end or bollard.

Some synthetic materials lose **strength** when left immersed in water for long periods of time.

1.2 Fibre Rope Lay

The way fibres, yarns and strands are twisted together is called the **lay** of the rope. The most common type of rope, 3-stranded rope, is usually “laid up” as follows:

- Right Hand (RH) Lay or 'Z' Lay
- Left Hand (LH) Lay or 'S' Lay
-

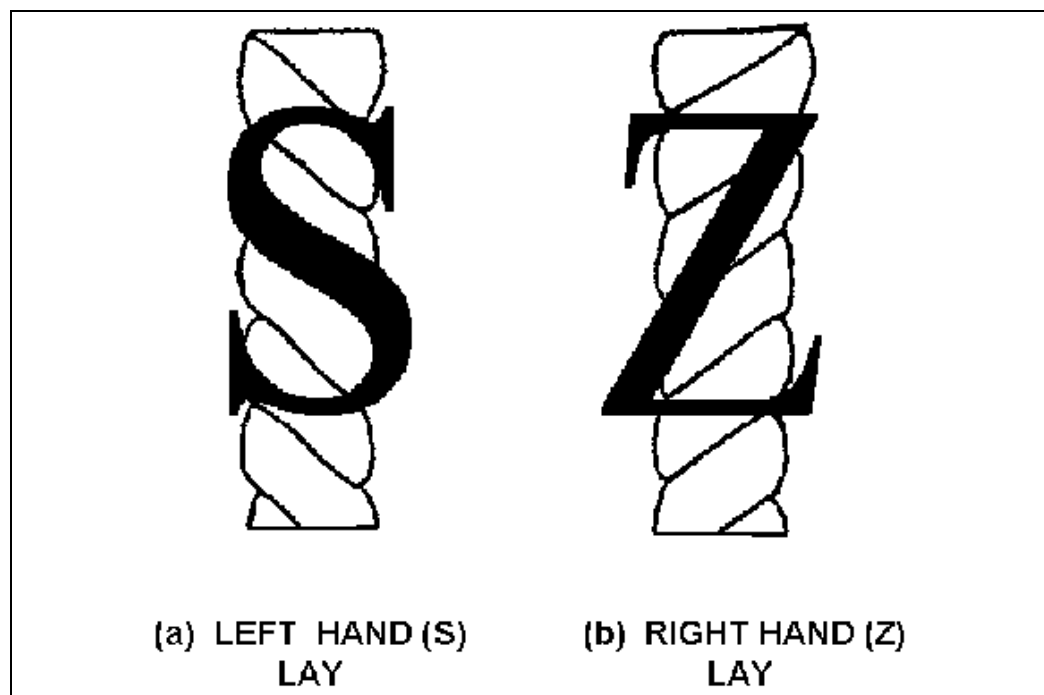

Figure 7.2 Rope Lay

1.3 Fibre Rope Size

A rope's size is measured across the **diameter** of the rope and is measured in **millimetres (mm)**. The diameter may be measured using a rule, tape measure or a set of callipers, but it must be remembered that:

1. The rope's diameter is measured across the *widest* part of the rope.
2. The ropes diameter is measured in *millimetres*

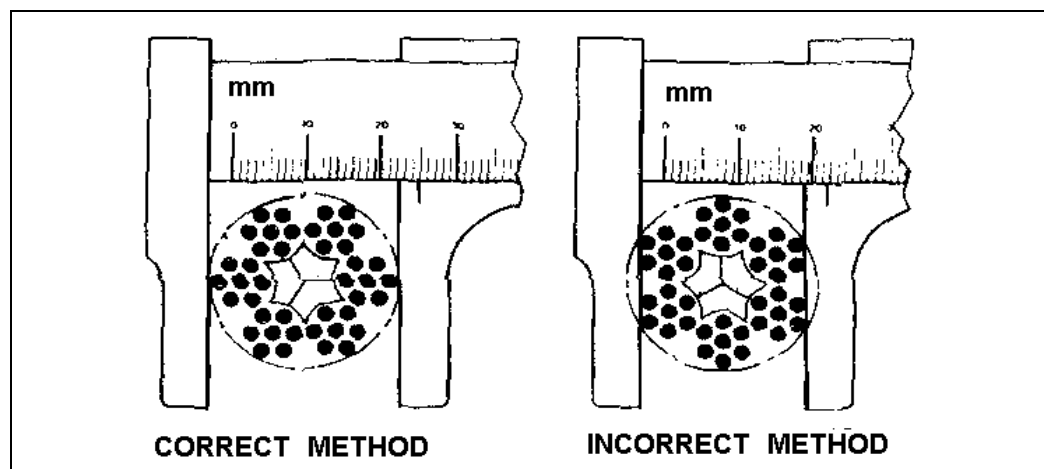

Figure 7.6 Measuring the size of a rope

1.4 Fibre Rope Strength

When thinking about the strength of fibre ropes we must consider 2 main factors:

- 1 Breaking Strain
- 2 The Safe Working Load

1.4.1 Breaking Strain (BS)

The Breaking Strain of a rope is: *"The ultimate strain on a rope at failure"* and is measured in **kilograms (kgs)**

In other words if a rope has a Breaking Strain of 100kgs it would break when the load applied to it reaches 100kgs.

1.4.2 Safe Working Load (SWL)

The Safe Working Load of a rope is *“the maximum load that should be applied to a rope”*.

The Safe Working Load is **one sixth that of the Breaking Strain**.

That is, if A-B in the figure below is the strength of a rope, the Breaking strain at B is 6 times the SWL.

A ROPE MUST NEVER BE USED BEYOND ITS SWL

2. FIBRE ROPE DAMAGE

Fibre ropes can be damaged in a number of ways. By knowing what causes such damage you can take the necessary steps to prevent or reduce it.

Table 3 Sources of damage to fibre ropes.

Damage	Caused By	Indicated By
External wear (wear on outside)	wear and tear	surface of outer fibres are flattened or broken
Internal wear (wear on inside)	repeated flexing of the rope particularly when wet	- white powder in the lay - loose strands
Overloading	- excessive shock loads - working beyond SWL	- rope has stretched but not sprung back - reduction in diameter - hardening of rope
Chemical attack	prolonged periods of exposure to chemicals or chemical fumes	- staining - flaking of fibre particles (like dandruff)
Attack by heat	very high temperatures	- melted fibres - glazing of rope surfaces
Ultra-violet radiation (sunlight)	Too much exposure to sunlight	flaking of fibre strands

One or more **knots** will reduce the strength of rope by as much as **50%**

One or more **splices** will reduce the strength of rope by as much as **10%**

3. MAINTENANCE AND CARE OF FIBRE ROPES

1. Keep clear of all sources of grit.

- Grit such as sand, rust flakes, cargo dust etc can work its way between the strands and cut them like small razors.
- Wash the ropes thoroughly to remove such problems

2. Avoid unnecessary chaffing.

- All surfaces over which ropes run such as drum ends, bollards, fairleads, etc must be smooth and free of rust.
- Sharp angles must be avoided
- protect ropes by covering with a chaffing sleeve (scotchman)
- When joining fibre rope to steel wire rope use a shackle to keep them apart to prevent the wire from chaffing the fibre.

3. Store ropes correctly

- if possible store in a cool, dry, well ventilated area, off the deck, and out of direct sunlight.
- do not store ropes in the same space as chemicals such as paints, thinners, cleaning solutions, petrol etc.
- ropes that have had chemicals spilt on them should *immediately* be washed with clean water.
- Always keep ropes properly whipped or seized otherwise they are difficult to use and can be dangerous.
- keep ropes properly coiled when not in use

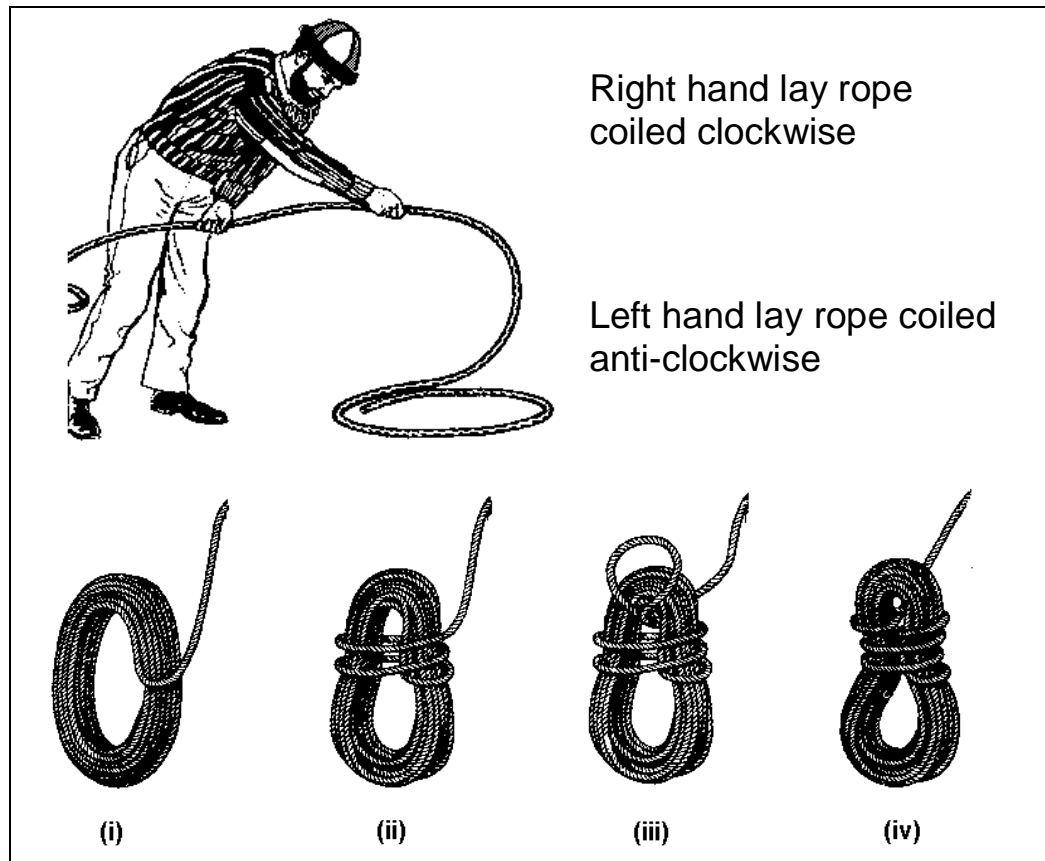
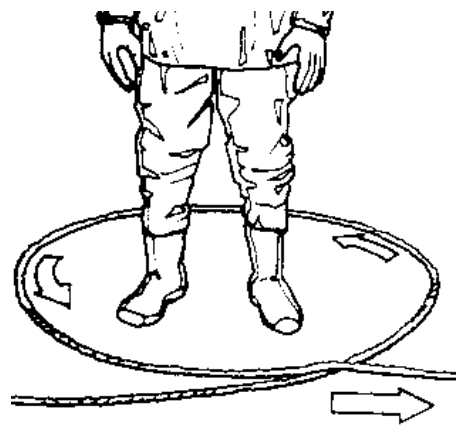

Figure 7.8 Coiled Ropes

4. SAFE USE OF FIBRE ROPES

- *Stand well away from a rope under tension*, particularly synthetic ropes. If a line is under extreme tension, slack it off until there is no tension or get out of the way. A parting rope under tension will fly back (because its extreme elasticity) and will hurt if not kill you.

- *Never stand in the bight of a*



- *Replace knots with splices* wherever possible, a splice loses less strength than a knot.

- Do not weaken ropes by *overloading, bending at sharp angles, chaffing, or exposing to heat or chemicals.*
- *Never use a rope beyond its Safe Working Load*
- *Always inspect a rope carefully* before using it.
- *Don't let ropes or lines dangle over the side* where they can foul the propeller.
- *Don't throw pieces of rope over the side* where they can be a danger to other vessels and marine life.
- *Never strain a rope that has twists and turns* as it will kink. A kink has the same effect on strength as a knot.

5. KNOT WORK

GENERAL

It is a basic principle of knotwork that "*knots that hold under some conditions will slip under others*". It is also possible to tie a knot only to find that it is the wrong knot for the job. This may be worse than tying the right knot the wrong way, because the mistake is seldom recognised until it is too late.

Knots tied in a rope under tension must be carefully pulled tight in each part as the knot is being formed. When not under tension the knot should be formed carefully and tightly so that there are no loose or slack parts of rope within the knot. This makes sure that there will be no internal jerk when the tension comes on i.e. sudden take up of slack.

It isn't a knot until it has been formed correctly and tightened.

You should be familiar with what the finished knot should look like because if it doesn't look right then chances are it isn't. Be sure that everything is in the right place before finally tightening.

All knots are liable to slip a little as they take up a load, *especially synthetic ropes*. Polyethylene slips most, polypropylene least for the same knot, and stiff ropes slip more than flexible ones. The extra **tail** in a knot should allow for this slippage.

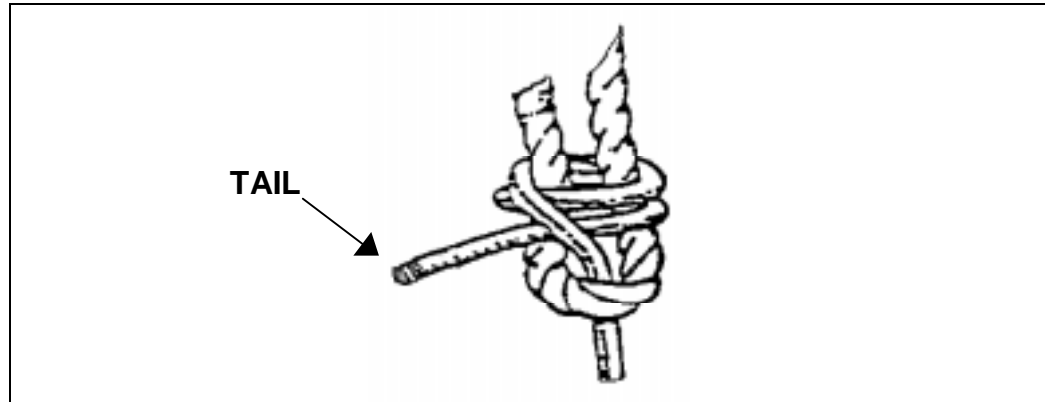

Figure 7.23 The Tail of a rope as part of a knot.

You should leave a "tail" in a knot of 3 - 5 times the rope diameter for natural fibre ropes, but synthetic ropes need more (up to 20 times the diameter for a very stiff rope). A good rule of thumb is that a tail should be long enough to tie an overhand knot in it.

Once you have learnt to tie a knot, practice it in the dark, or behind your back, or left-handed, or one-handed, or all four! Practice makes perfect.

If your life depends on it.....**TIE YOUR OWN KNOTS.**

5.1 Important Terms

All ties or fastenings that use rope fall into three general areas of classification:

KNOTS

HITCHES

BENDS.

A knot

A tie made in a rope, and usually requires the use of only one end of the rope.. Both ends may be used if the rope is short enough.

A hitch

Mainly used for attaching a rope to another object such as a post, spar, railing, stage, etc.

A bend

Used for joining two ropes together so they can stand the strain of being used as one long rope.

5.2 Knots, Bends and Hitches

You will be required to learn the following knots, bends and hitches. They are by no means the total of the knots you will need to use throughout your life at sea, however they do include the most common ones used at sea today.

Figure of eight knot	Round Turn & Two Half Hitches
Reef knot	Clove Hitch
Sheet Bend	Rolling Hitch
Double Sheet Bend	
Bowline	

5.2.1 Figure of eight knot

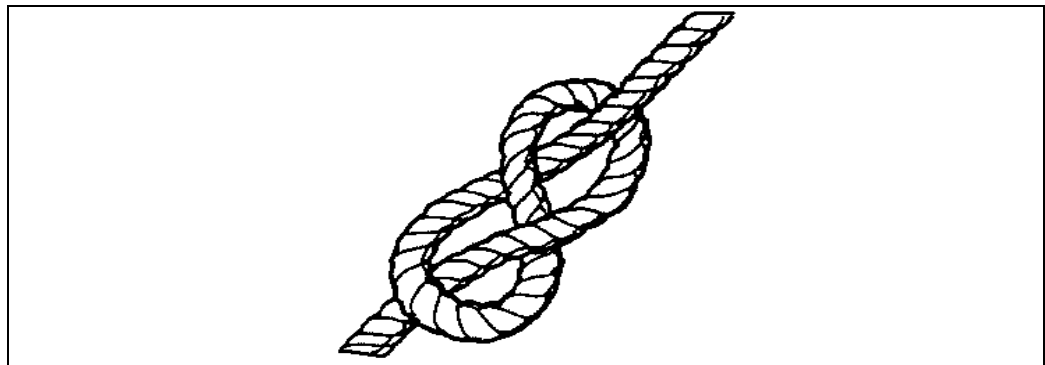

Figure 7.25 Figure of 8 knot

Usually tied into the end of a purchase (rope in a block and tackle) to prevent the rope from running through the block. If the knot jams in the block it can easily be pulled out if the tail of the knot is sufficiently long.

5.2.2 Reef knot

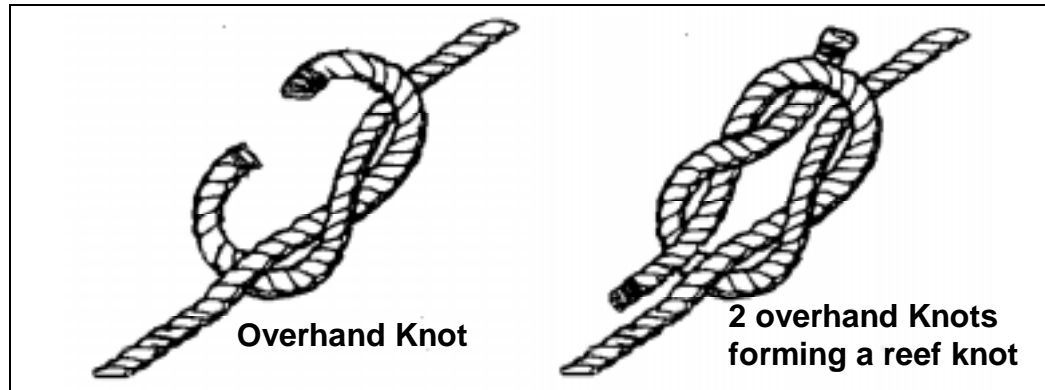

Figure 7.26 Reef knot

Consists of 2 overhand knots made one above the other. A simple rhyme can be used to remember how it is made:

“Left over Right and under
Right over Left and under”

Used to tie two ropes of equal diameter together.

NEVER use a Reef Knot to tie two ropes together that will be under tension, particularly synthetic ropes. The knot will slip and collapse.

5.2.3 Sheet Bend

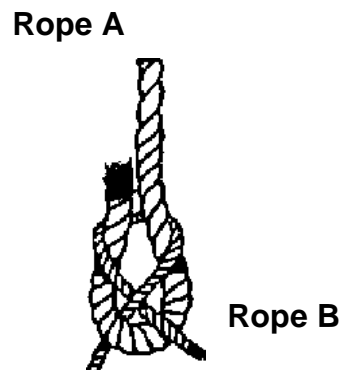

Figure 7.27 Sheet bend

A very useful knot for tying two ropes together of different diameter, and for ropes that will be under tension.

When tying ropes of different diameter together, *always* form the loop with the larger rope. In the diagram the loop has been formed by Rope A.

5.2.4 Double Sheet Bend

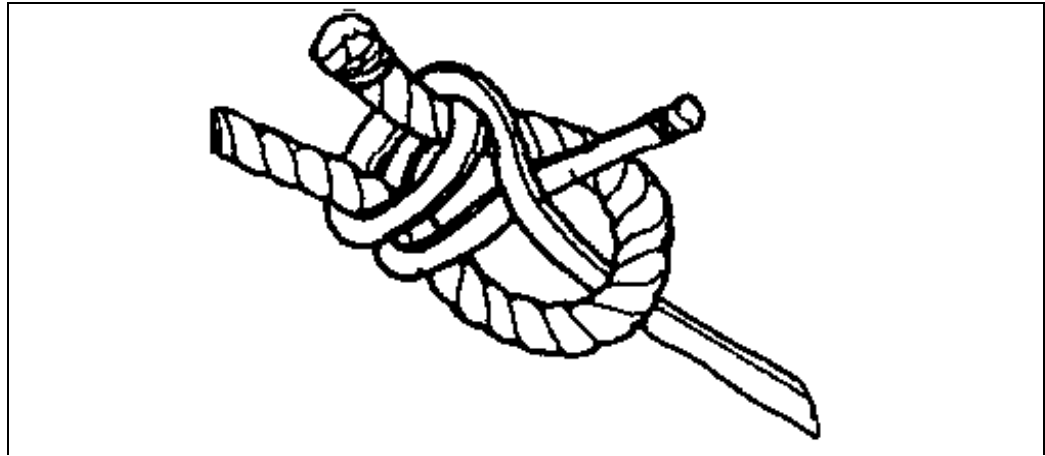

Figure 7.27 Double sheet bend

Very similar to the single sheet bend except it has an extra turn around the loop.

5.2.5 Bowline

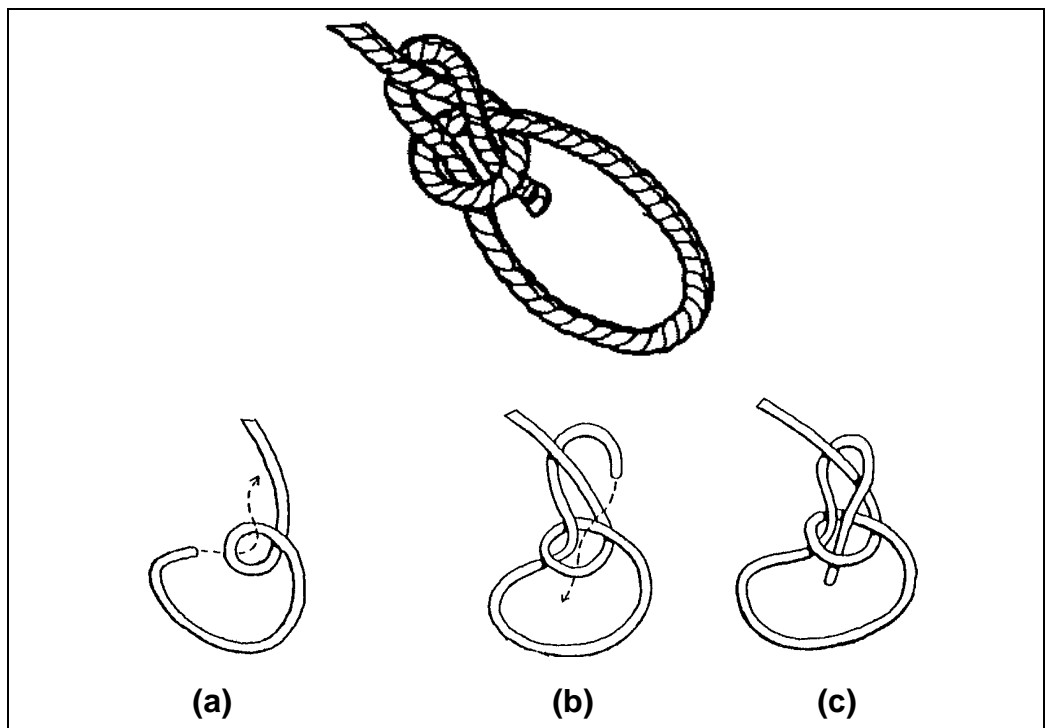

Figure 7.28 Bowline

Some of the applications a bowline is very useful for:

1. making temporary eyes in ropes of all sizes
2. attaching a heaving line to a mooring line
3. as a life-line around a person's waist

4. joining two lengths of rope together.
The main advantages of the bowline are:

- does not slip
- easy to undo even after high loading
- can be tied one-handed.

The main disadvantages of the bowline are:

- cannot be tied or untied when rope is under load

5.2.6 Round Turn & Two Half Hitches

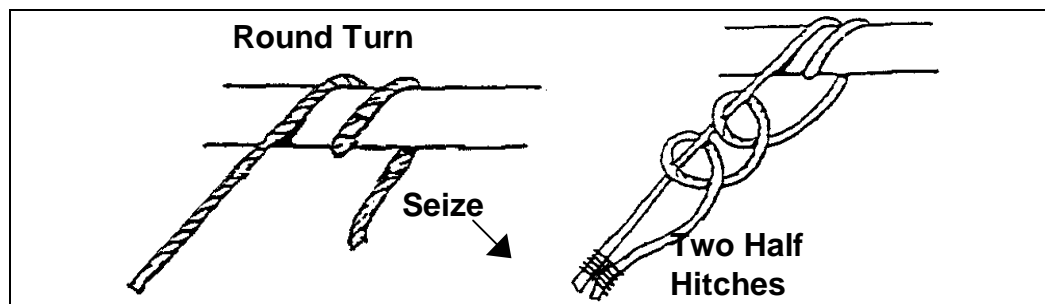

Figure 7.30 Round turn & 2 half hitches

Useful in securing a heavy load to a spar, ring or shackle. It can be tied quickly with the load taken by the round turn while the two half hitches are tied.

For long term application it is recommended that the tail be seized to the standing part to prevent it from slipping out.

5.2.7 Clove Hitch

A good knot for securing a length of rope to a rail, spar or similar fitting. It is easily applied and, if not subjected to excessive loading, easily undone. It can be made with either the end of a rope or with the bight of a rope, and to prevent the tail from slipping out when under load, tie it off to the standing part with a half-hitch.

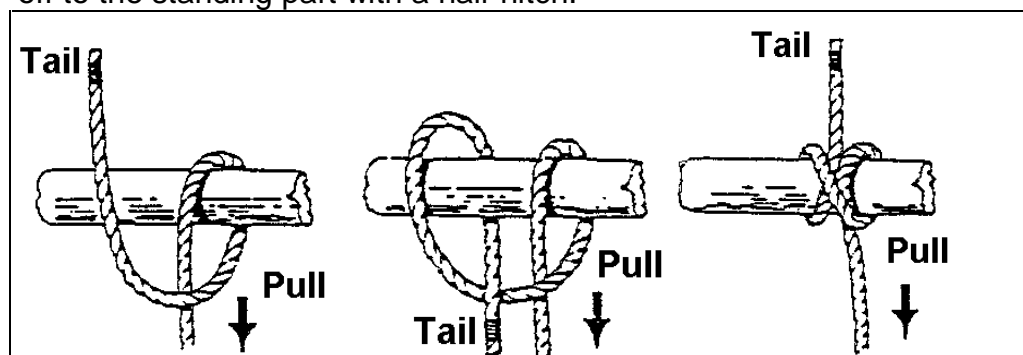

Figure 7.35 Clove Hitch made with the end of a rope

5.2.8 Rolling Hitch

Similar to a clove hitch but with an extra turn. Used to secure a rope tail to a larger rope or spar when the direction of pull is along the rope/spar/post in one direction only.

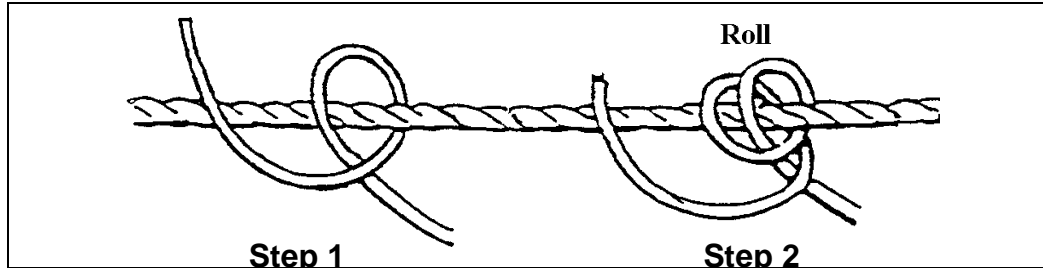

Figure 7.37 Rolling hitch

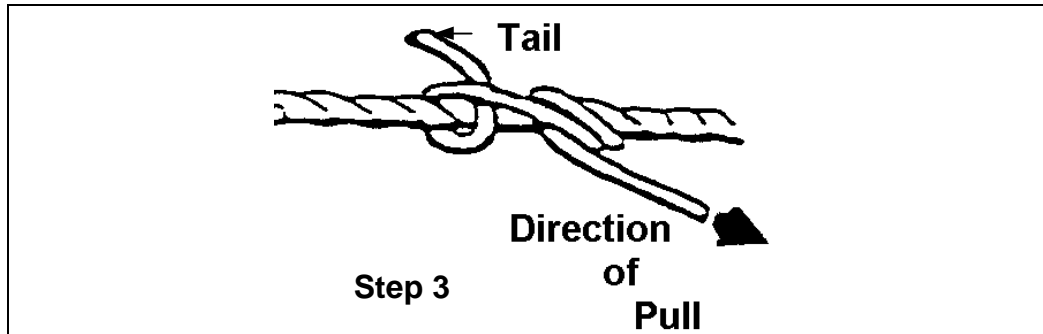

Figure 7.38 Rolling Hitch on another rope

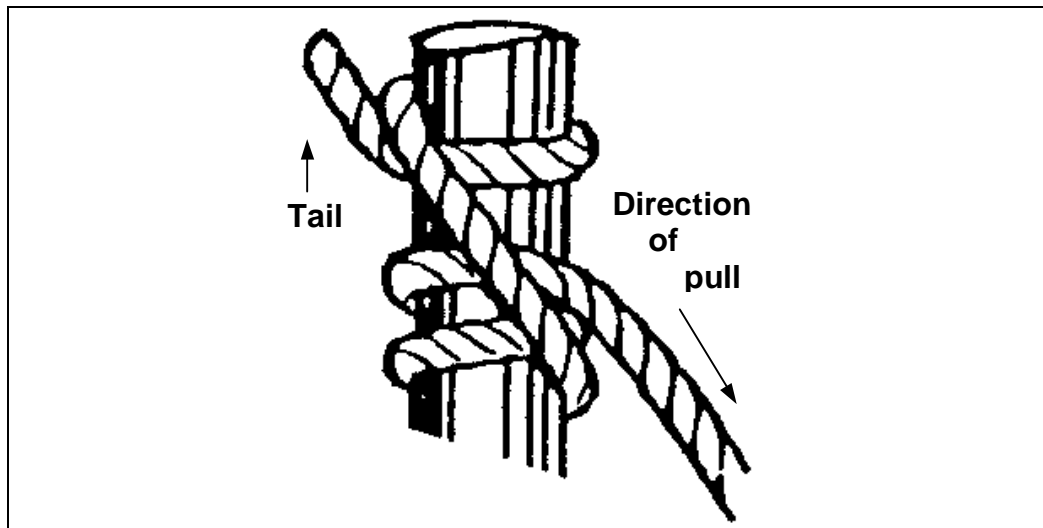

Figure 7.39 Rolling Hitch on a post

6. EYE SPLICE

An Eye splice is used to form a permanent eye in the end of a rope. Eyes can be formed around a thimble (referred to as a hard eye) or without a thimble (a soft eye). The following soft eye splice is for 3 - strand fibre rope.

STEP 1

(a) Unlay the 3 strands with enough to form the required number of tucks.

- Natural fibre rope 3 tucks
- Synthetic fibre rope 4 tucks (because of its slippery nature)

(b) Decide on how big the eye must be.

(c) Lay the strands over the standing part of the rope in the manner shown in figure (a)

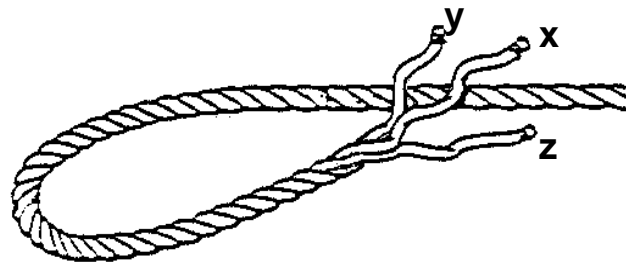

Figure (a)

STEP 2

Select the middle strand (x) and tuck it under one strand to the left, against the lay. Figure (b)

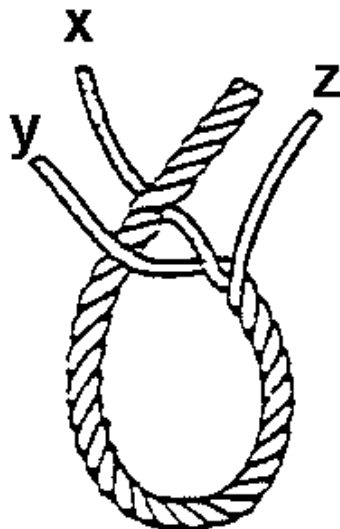

Figure (b) Tucking 1st Strand

STEP 3

Take the strand (y) and tuck it under the next strand to the left of the strand that (x) went under. Figure (c)

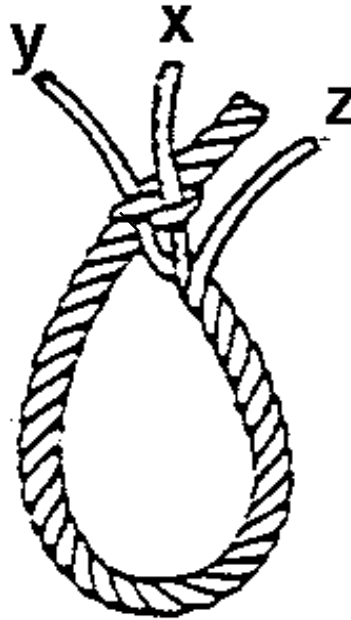

Figure (c) Tucking 2nd Strand

STEP 4

Take the strand remaining (z) and tuck it under the strand to the right of the one that (x) went under. Strand (z) actually goes over the strand to the right and then is tucked back under it so that it runs against the lay. Figure (d)

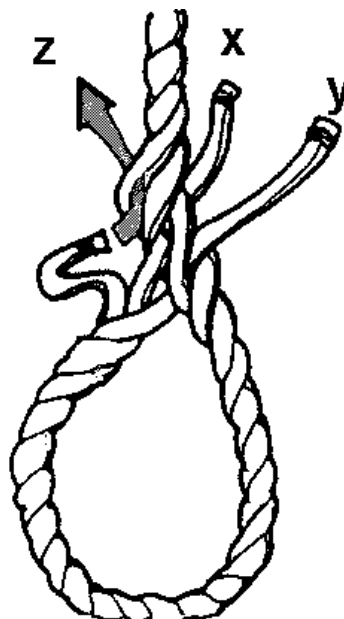

Figure (d) Tucking 3rd Strand - View from back of the splice

STEP 5

- (a) Pull each strand through until it is tight. (Be careful not to pull too hard or you may distort the lay of the rope).
- (b) Select any of the three strands and tuck it once again under one strand - to the left - against the lay,.
- (c) Do the same with each of the other two strands.
- (d) Repeat (a) to (c) until the required number of tucks have been made.

STEP 6

Cut off the tails of each strand so they do not stick out and cause a potential problem when using the rope.

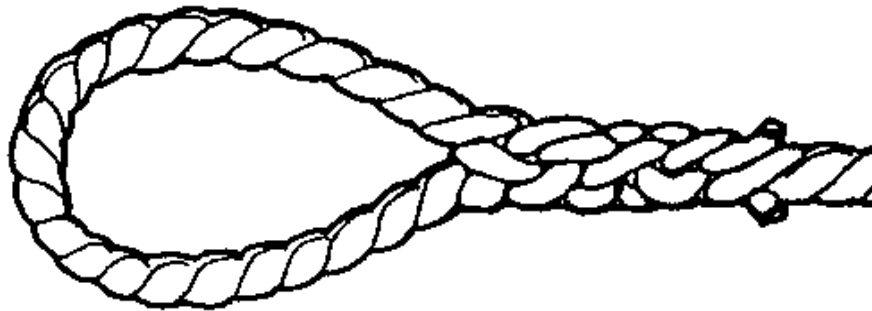

Figure (e) A completed soft eye splice

Section 8

Navigation

1. NAVIGATIONAL CHARTS

Navigational charts are basically maps of the sea, used for marine navigation, and are quite similar to land maps. A navigational chart however, includes much more information of the sea and some of the important features around the coast that might be useful to the mariner. They are produced from surveys made of the sea and the coastlines.

The most common charts that we will use are published in the UK, by the British Admiralty. Charts produced by various international hydrographic authorities, covering a large area may be published as an international series, and these are prefixed 'INT'. Charts may also be published by the local hydrographic authority or the navy.

1.1 Information about the Charts

1.1.1 Number and Title

The number of a chart usually appears on the top left hand and bottom right hand corners. Refer to Figure 8.1 which is the top left hand corner of a chart.

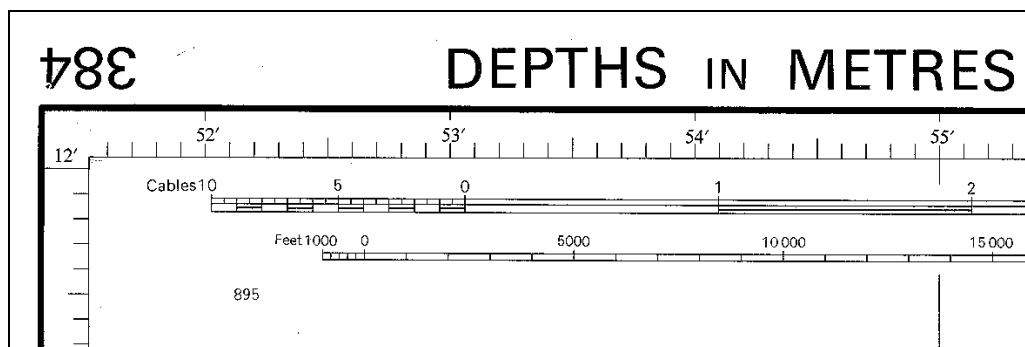

Figure 8.1 Chart Number

This is Chart 384 published by British Admiralty so it is common to call it Chart BA 384. This 'BA' prefix distinguishes the chart from a possible Chart 384 produced by another hydrographic authority. For example, Australian Charts are prefixed 'Aus', and New Zealand Charts, with 'NZ'.

In order to purchase a chart, you have to describe it by its Chart Number and Title. The Title, and other information about the chart is normally at a convenient location on the chart, where it will not obscure any essential navigational information. This lot of information about the chart, including the Title is called the Title Block. Look at Figure 8.2.

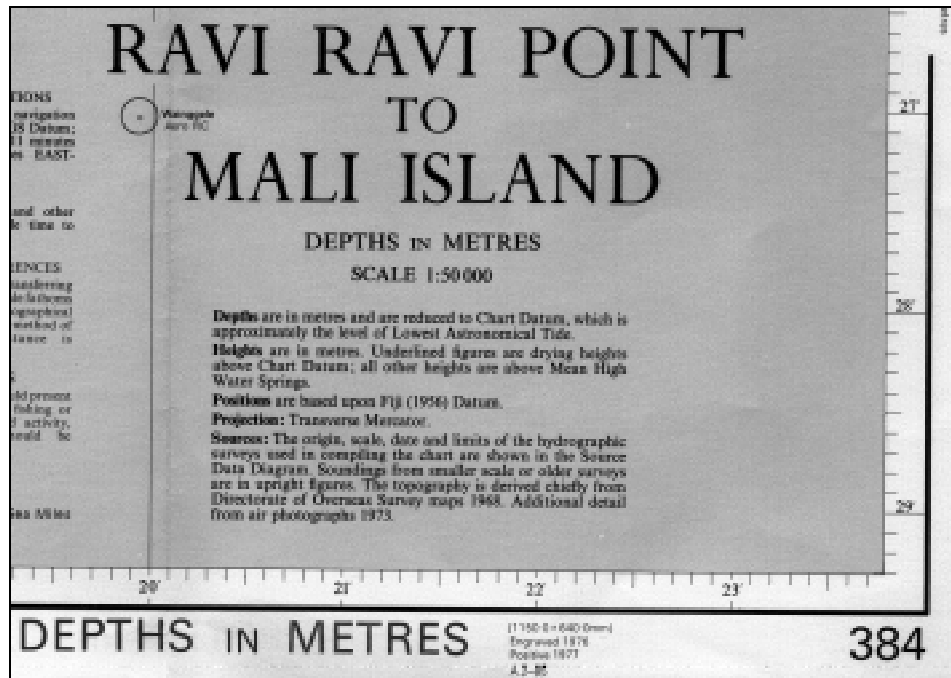

Figure 8.2 Title Block

Thus, should you need to purchase this chart you should describe it as :
 BA 384 RAVI RAVI POINT TO MALI ISLAND

1.1.2 Scale

From the Title Block in Figure 8.2, we can see that the scale of BA 384 is 1:50,000.

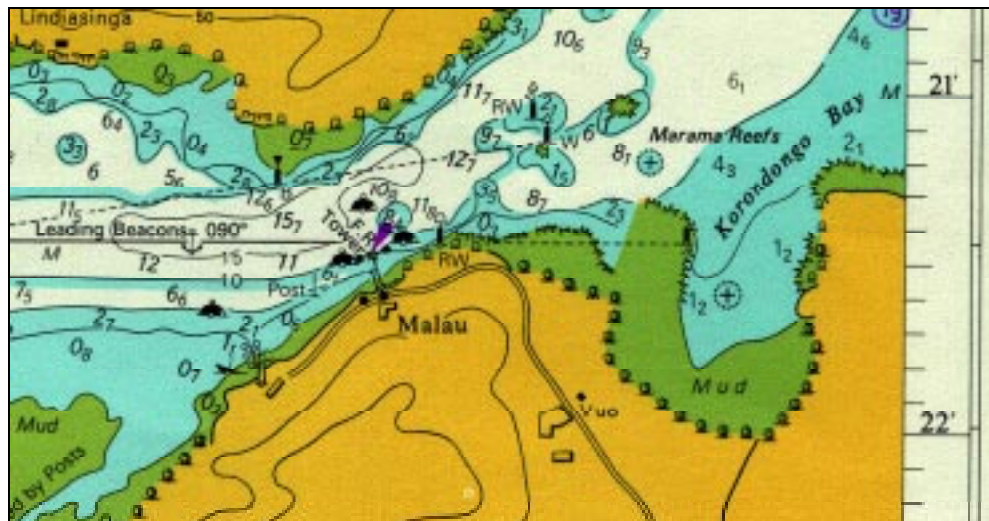

Figure 8.3 Section of Chart BA 384, scale 1:50,000

Now let us have a look at a section of another chart. The scale of Chart INT 603 is 1:3,500,000.

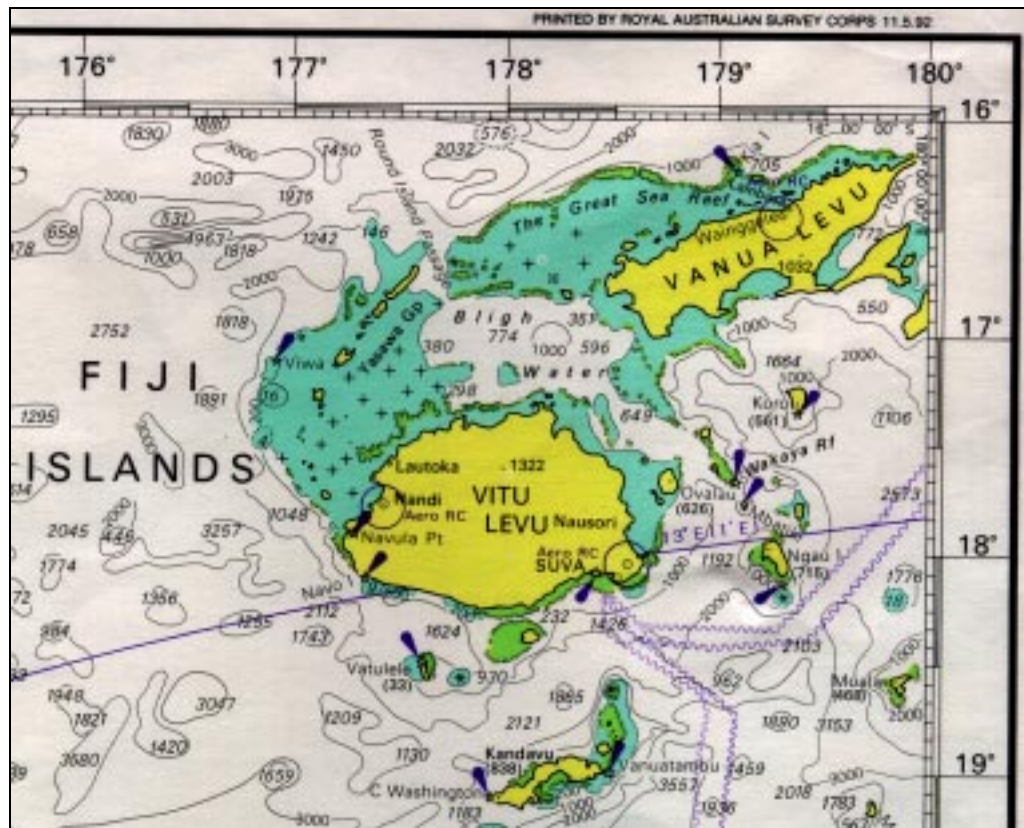

Figure 8.4 Section of Chart INT 603, scale 1:3,500,000

Notice the difference in scale between the two sections :

Chart Number	Chart BA 384	Chart INT 603
Scale of Chart	1:50,000 (large scale)	1:3,500,000 (small scale)
Charted features appear	Larger	Smaller
Coverage	Small Area	Large Area

1.1.3 Units of Measurement

Depths indicated on the chart may be measured in Metres (Metric units) or in Fathoms and Feet (Imperial units). A fathom is equivalent to six feet. Normally, this is very boldly indicated on the chart, close to the Chart Number and also in the Title Block.

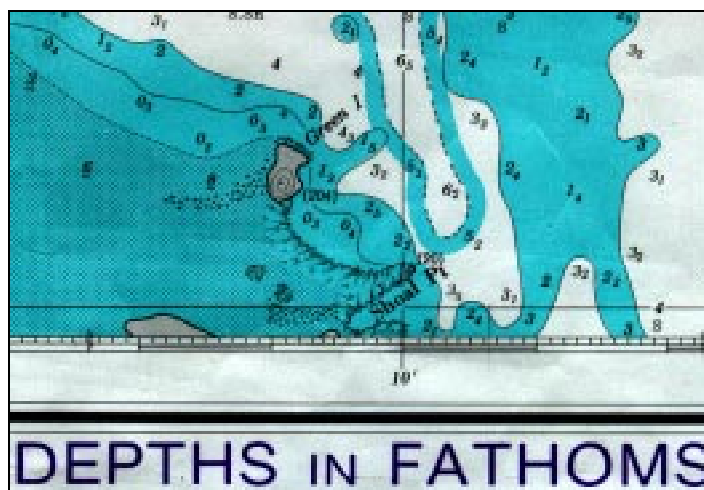

Figure 8.5 Section of Chart Aus 252, Depths in Fathoms

- ◆ Metric Charts (metres)
On a Chart marked 'DEPTHS IN METRES', a depth of 4.5 metres is indicated as :

4₅

All heights are also measured in metres.

- ◆ Imperial Charts (fathoms & feet),
On a Chart marked 'DEPTHS IN FATHOMS', a depth of 3 fathoms 4 feet (22 feet) is indicated as :

3₄

All heights are measured in feet.

1.2 Information on Charts

Charts contain plenty navigational information. In order for everything to be printed on the chart, information has to be brief. Thus the information appears in the form of symbols and abbreviations. You should now start to familiarise yourself with all the symbols for danger. Obtain a copy of the BA 5011 Symbols & Abbreviations used on Admiralty Charts.

1.3 Depth Contours

You will notice, on the chart, there are many other lines printed, joining places of equal depth and some areas are also coloured in blue. These help to provide a clearer picture of the contour of the sea bottom.

2. DISTANCES

2.1 Measuring Distances on Charts

On a chart, a degree of latitude is equivalent to 60 nautical miles. Since one degree is 60 minutes, one minute of latitude is equivalent to one nautical mile.

1 degree ($^{\circ}$) = 60 minutes ($'$) = 60 nm on the latitude scale.

The longitude scale is not suitable to be used for measuring distances because it becomes progressively smaller towards the poles.

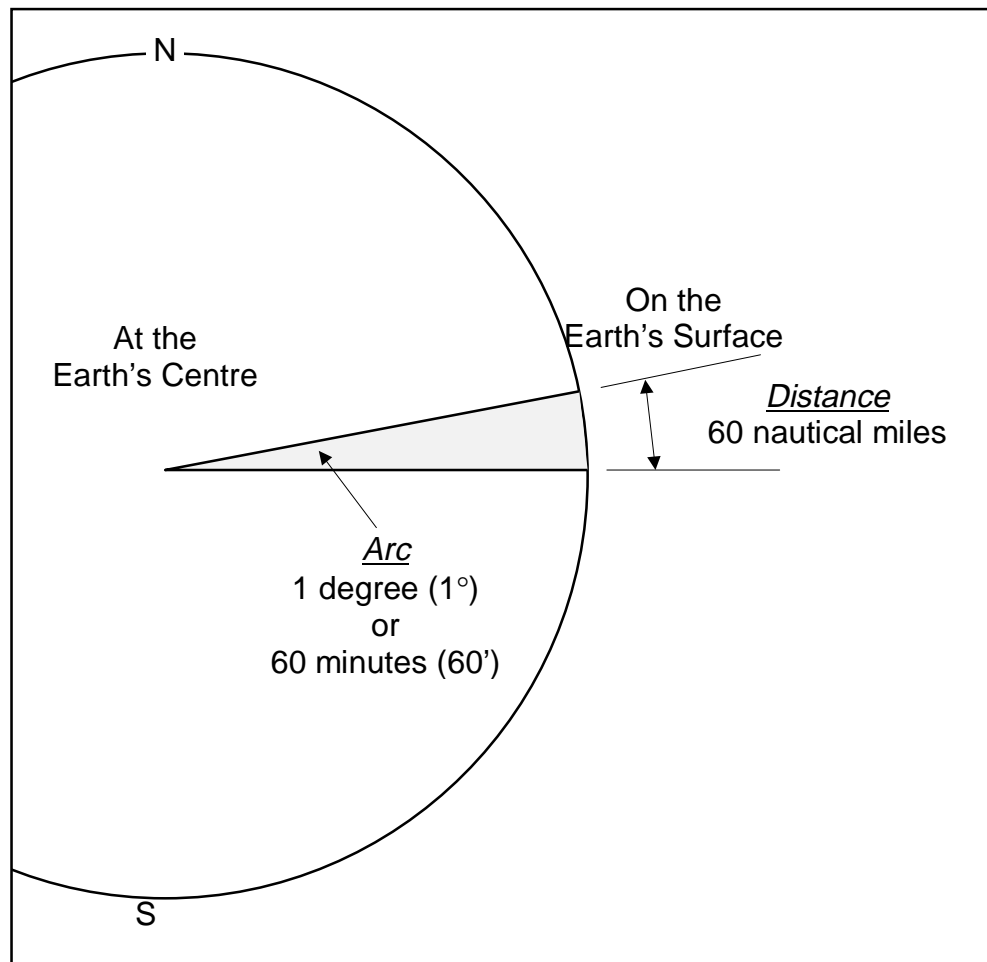

Figure 8.9 Measurement of Distance on the Earth's Surface

Always measure distances using only the Latitude Scale
(up along the sides of the chart)

Let us look at an example. Refer to Figure 8.10. Suppose we wish to measure the distance between the two beacons.

We use a pair of dividers to measure the distance on the chart and read it off the Latitude scale. Remember, 1' = 1 nm.

Thus, this distance is 0.8 nm and we can also write it as 0.8'.

Figure 8.10 Measuring Distances on the Chart

2.2 Speed, Time & Distance

On land, speed is measured in kilometres or miles per hour. At sea, speed is expressed in Knots.

1 Knot = 1 Nautical Mile (nm) per hour

If our speed is 15 knots, we travel 15 nm in 1 hour. Thus we would cover 45 nm in 3 hours if we kept the same speed.

Distance (nm) = Speed (knots) \times Time (hours)

Thus :

Speed (knots) = Distance (nm) \div Time (hours)

and

Time (hours) = Distance (nm) \div Speed (knots)

3. COURSE AND BEARING

On a chart, you will notice that there will be a Compass Rose printed at some convenient location similar to the one in Figure 8.11.

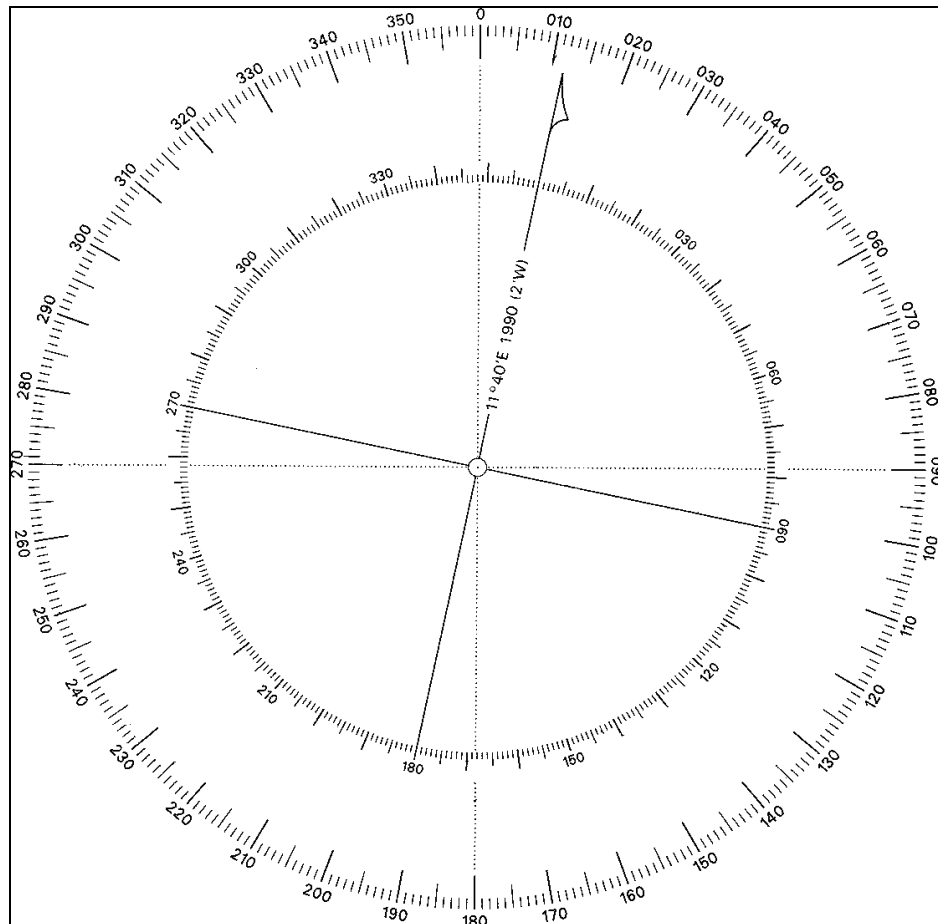

Figure 8.11 Compass Rose

A compass rose on the chart may be used to :

- Lay off a course,
- Plot a line of bearing,
- Obtain a bearing of one point from another

Let us see how this is done using a parallel ruler. Refer to Figures 8.12, 8.13 and 8.14.

The use of a parallel ruler takes a little practice. It is essential that you place the chart on a flat surface, first of all. Practice transferring bearings to and from the compass rose with as few movements as possible, as this will help reduce inaccuracies.

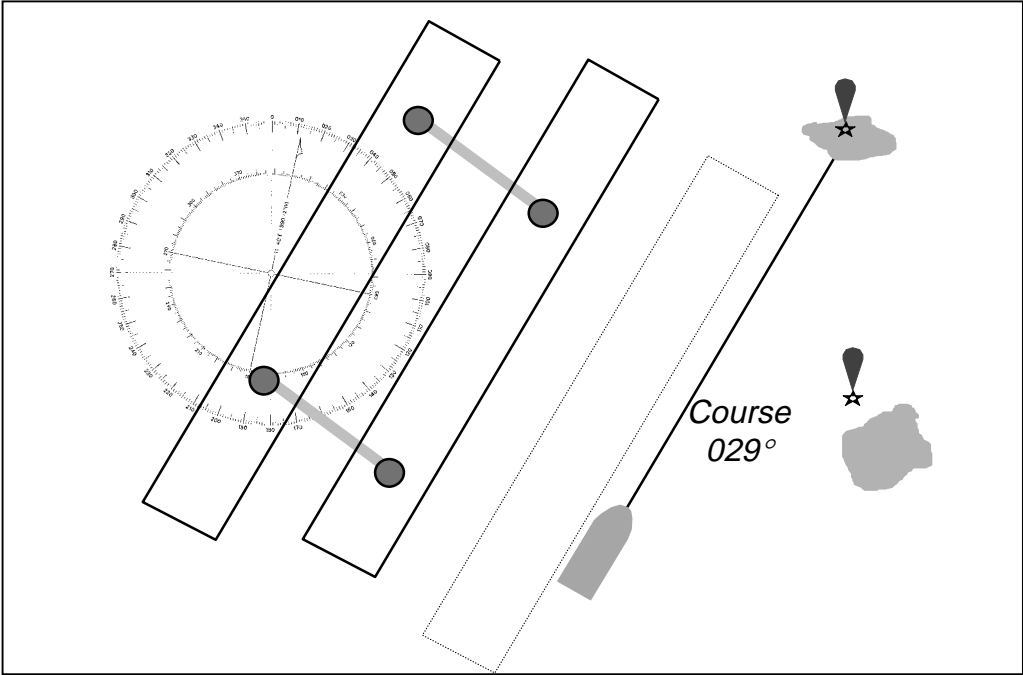

Figure 8.12 Laying Off a Course

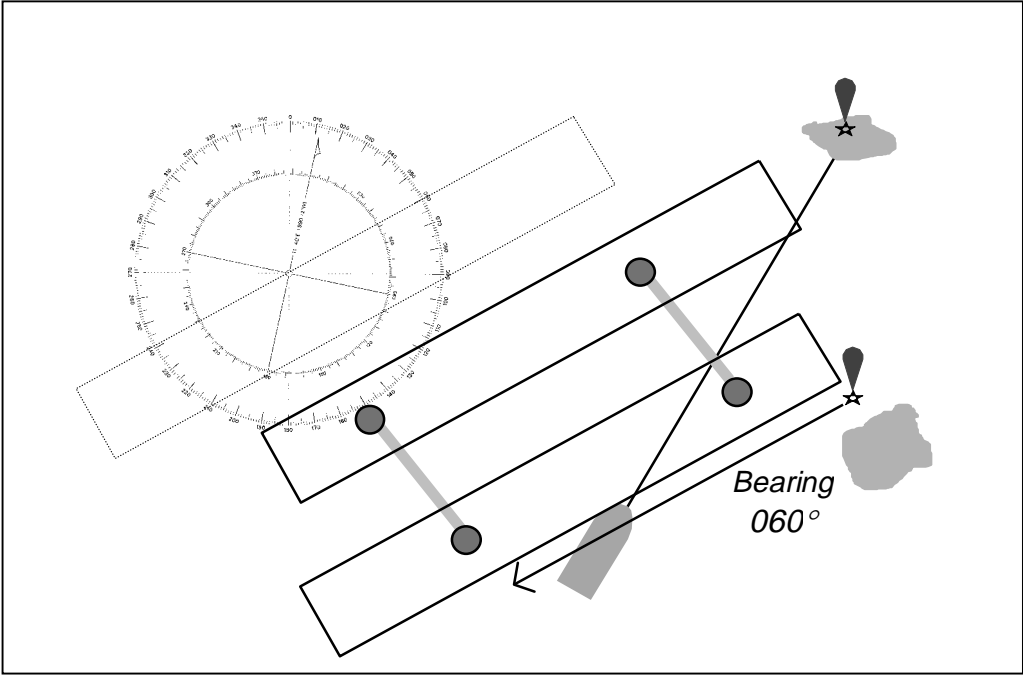

Figure 8.13 Plotting a Line of Bearing

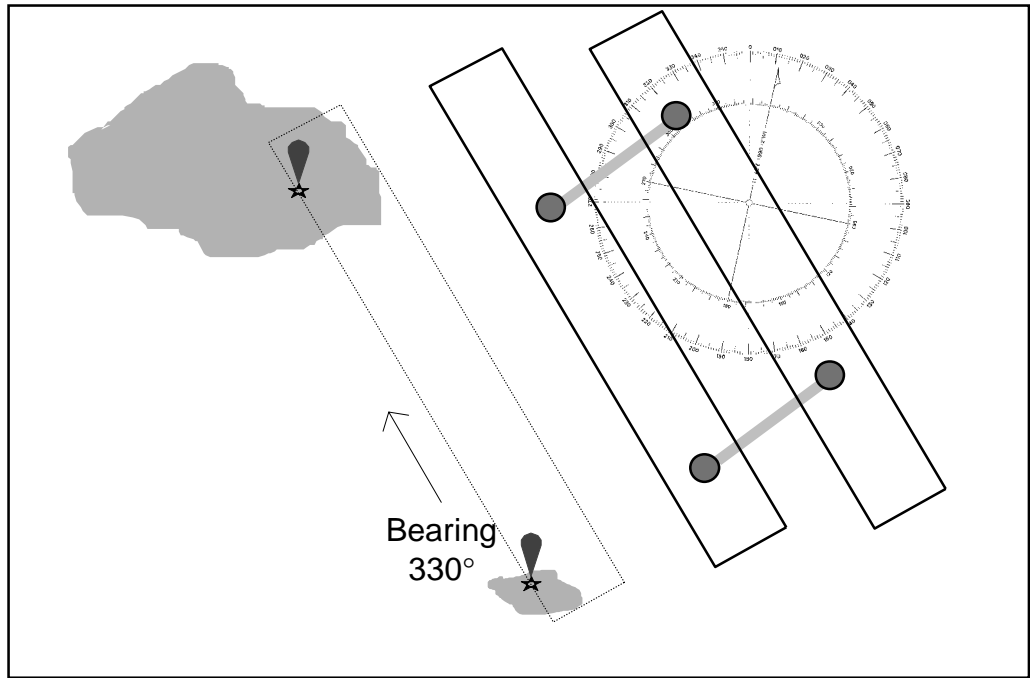

Figure 8.14 Measuring the Bearing of one point from another

4. NAVIGATING SMALL CRAFT

4.1 Leading Marks & Transits

Wherever possible attempt to plan a route using available coastal features as leading marks for reference. Refer to Figure 8.12. You may choose prominent objects such as navigation marks (beacons & lighthouses), hills, towers, piles distinct edges of land, masts, etc.

It is even better if you can use a transit of two distinct, conveniently located objects. Many harbours provide leading marks in transit to help guide vessels into port. These are very useful especially in the presence of currents, tidal streams and wind that could set the vessel off its intended route into danger.

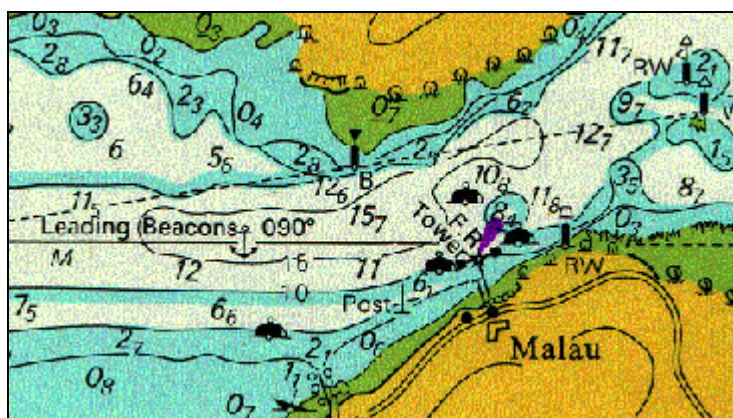

Figure 8.15 Leading Beacons

When there are no available objects marked on the chart, observe carefully how the bearings of the objects nearby change compared to distant objects. This alone can give a useful indication of how the vessel is setting. We always want to have at least a general idea how the vessel is moving in relation to the course we are steering.

When two charted objects are observed in transit, we know that we are somewhere along the line of the transit. A line along which the vessel's position lies, is called a Position Line. Refer to Figure 8.16.

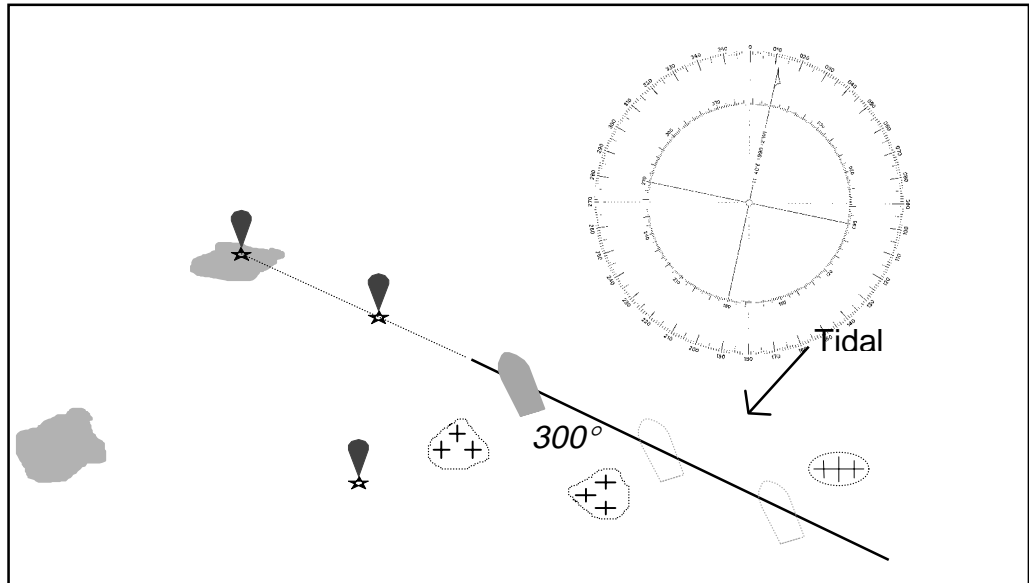

Figure 8.16 To obtain Position Line & Maintain a Safe Track

4.2 Beam Bearings

Obtaining position lines helps determine the position of the vessel in order to monitor its progress along the intended route. However, it is often difficult to accurately obtain bearings of charted objects without a compass or other equipment designed for the purpose. A convenient method to obtain bearings is through the use of beam bearings.

Refer to Figure 8.17. The vessel sails along a line of transit of two beacons. Another beacon is used as a beam bearing to determine position and change to a new course headed towards the right hand edge of the island.

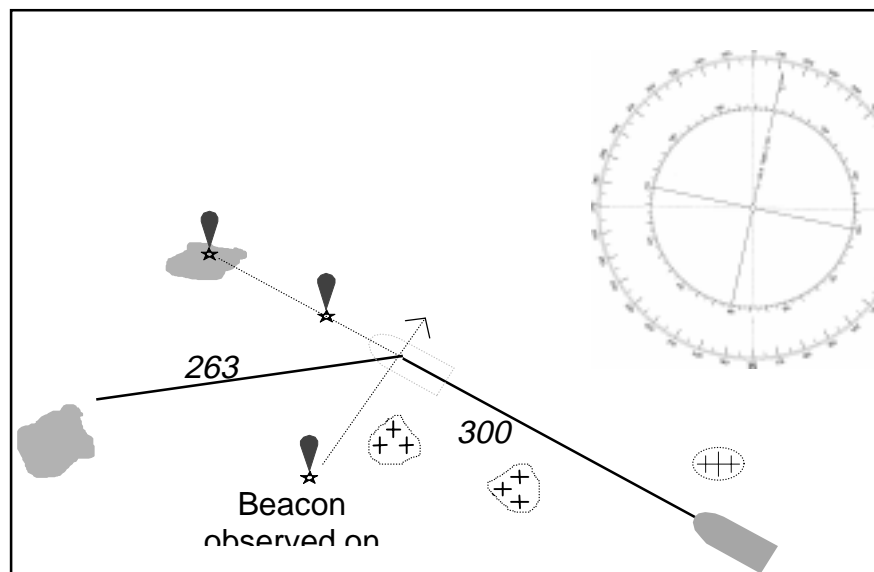

Figure 8.17 Use of Beam Bearing

Refer to Figure 8.21 for a clearer picture of the relationship between these terms.

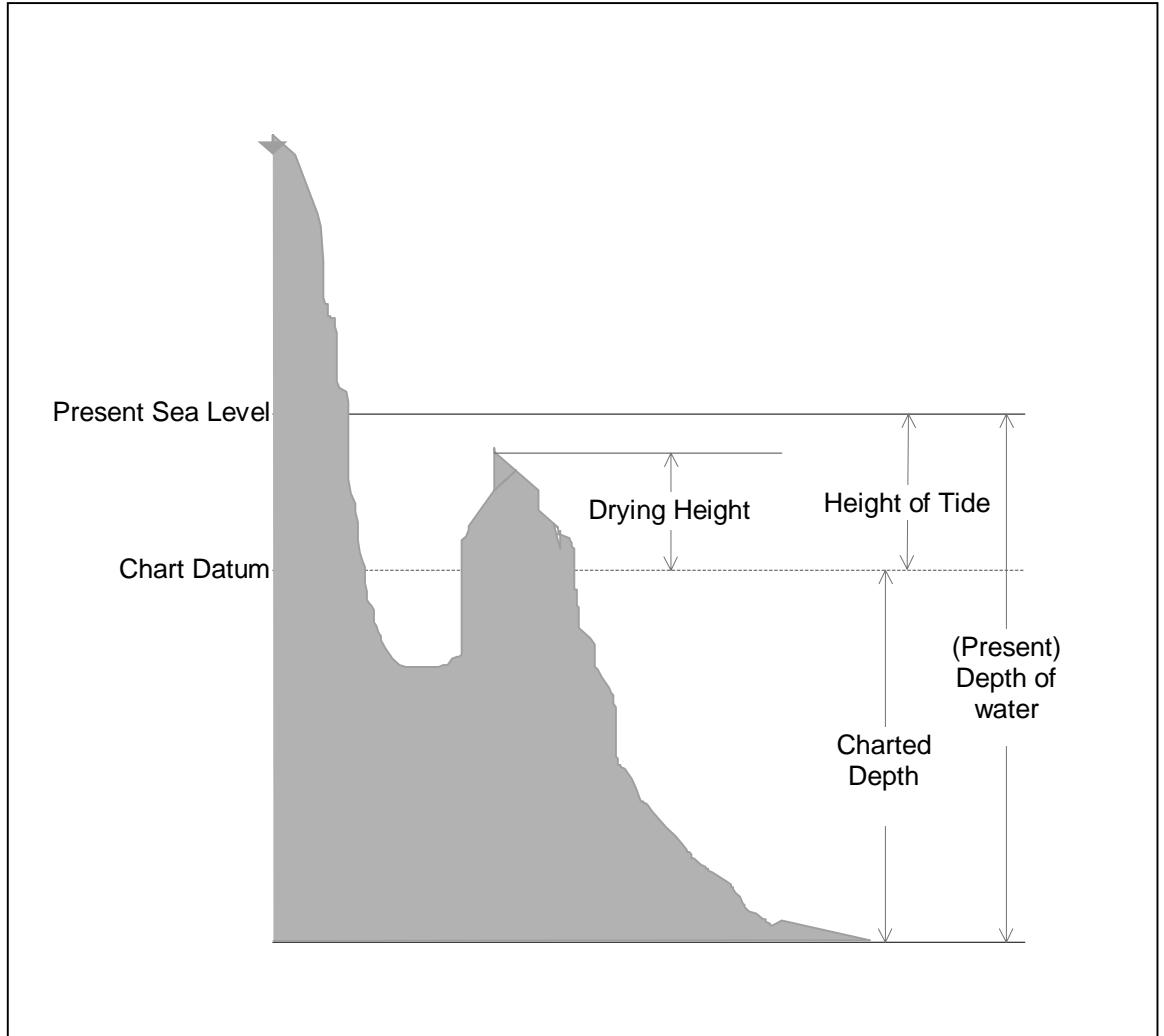

Figure 8.21 Terms used in Tide Predictions

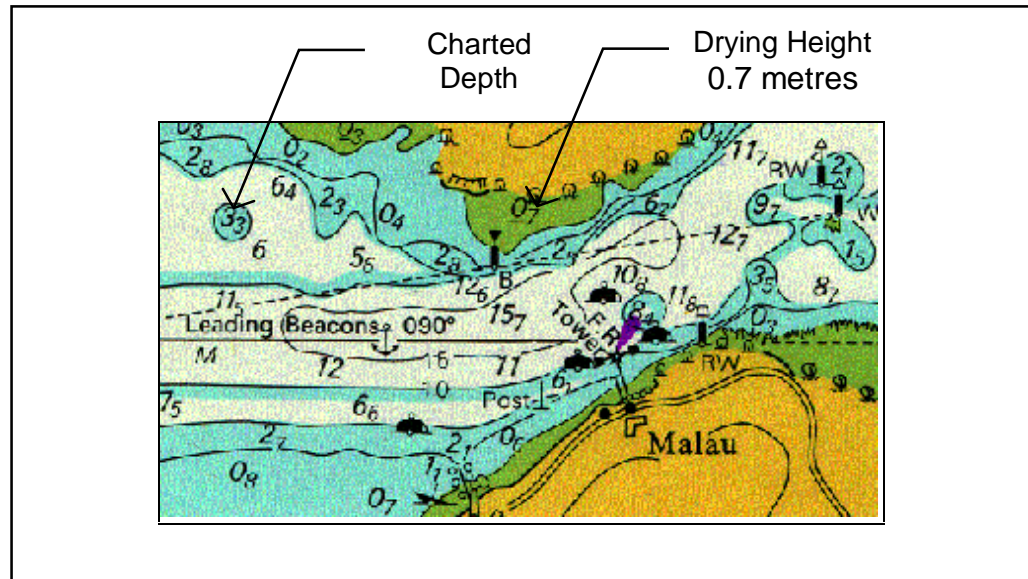

Figure 8.22 Charted Depth & Drying Height

Refer again to Figures 8.20, 8.21 & 8.22. On 17th November, at 1911 hrs, the Height of Tide is 1.8 metres at High Water.

The Height of Tide (1.8 metres) is measured above Chart Datum, which is the reference level used on the chart.

The shallow patch marked on the chart has a Charted depth of 3.3 metres. The Charted Depth is the depth measured below Chart Datum. Thus, at 1911 hrs, the depth of water over that shallow patch is 5.1 metres. (Charted Depth 3.3m + Height of Tide 1.8m)

At the position marked with a Drying Height of 07, the height of the bank is 0.7 metres above Chart Datum.

At 1911 hrs, the depth of water over the bank is 1.1 metres. (Height of Tide 1.8m - Drying Height 0.7m)

6. STEERING & OBTAINING BEARINGS

Although most of work you will be involved with will be in inshore waters where the compass might not be used too often for direction, you should still know how to use one for steering and obtaining bearings. In the event of poor visibility or darkness, you might not be in sight of the coastal features for direction and thus the compass becomes real handy.

Before we start, let us remember some important points first. The North indicated on the Magnetic Compass is different from the North as indicated on the charts. The magnetic compass aligns itself with the magnetic field at the location which is a combination of two things, the earth's magnetic field and the vessel's magnetic field. However, a magnetic compass can still be very useful.

Let us examine an example where a vessel uses a lighthouse as a leading mark and heads directly for it. The tidal stream sets the vessel north of the intended route. The navigator continually heads towards the lighthouse as the vessel continues to be set northwards into danger. At each of the stages (1) to (5) the compass bearing of the lighthouse is decreasing, indicating that the vessel is not sailing on a straight track.

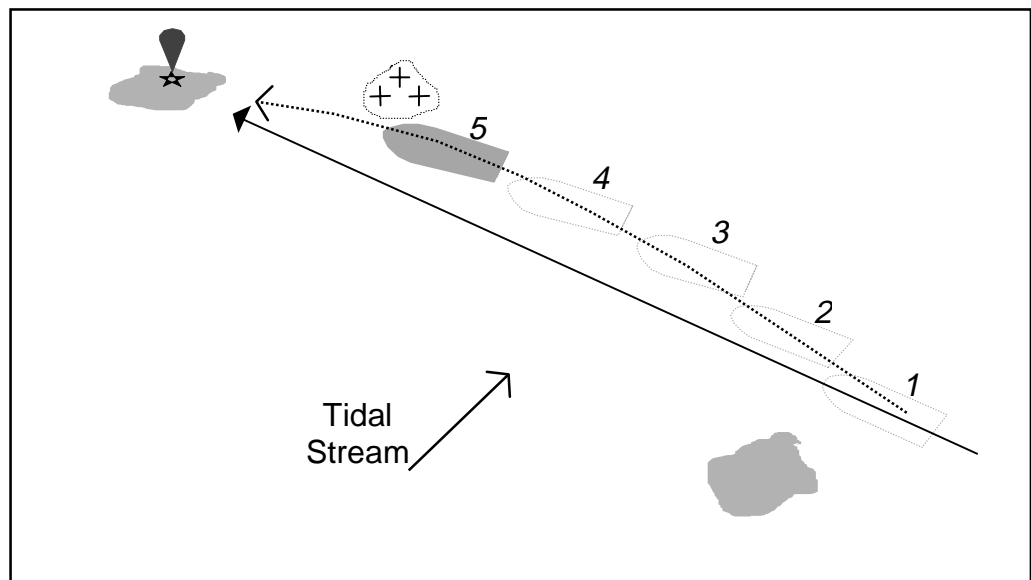

Figure 8.23 Heading directly for landmarks

Now, let us examine another example, which is a preferred situation.

Refer to the Figures 8.24 & 8.25. From a known position at stage (1), the navigator obtains a compass bearing of the lighthouse as 295° . The tidal stream initially sets the vessel northward but that is detected right away by the decrease in the compass bearing. The navigator adjusts the course steered to ensure that the compass bearing of the lighthouse always stays at 295° .

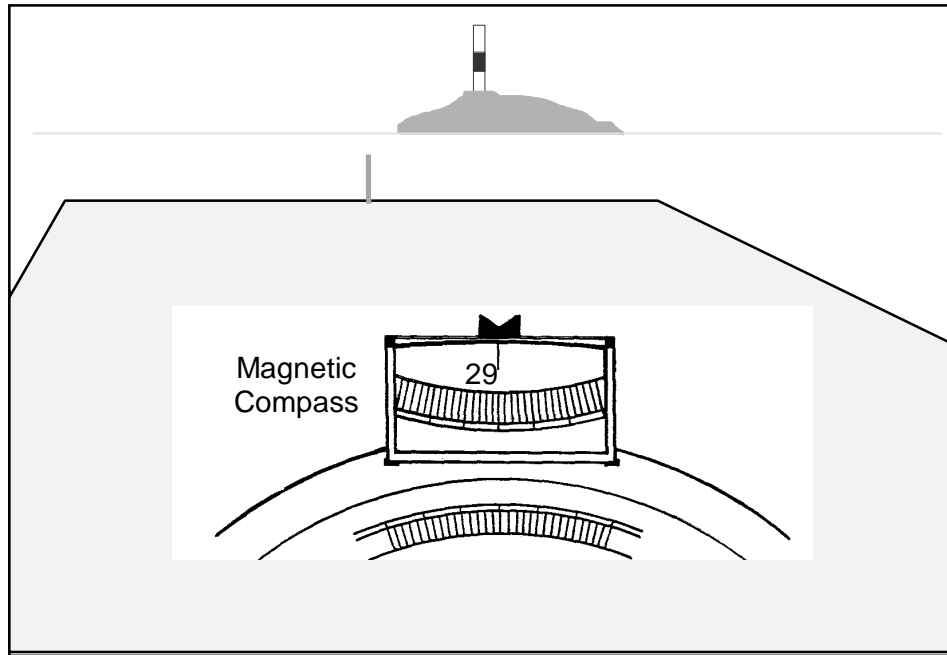

Figure 8.24 Obtaining a compass bearing

Thus, the vessel remains along the intended route and out of danger, unlike in the first example.

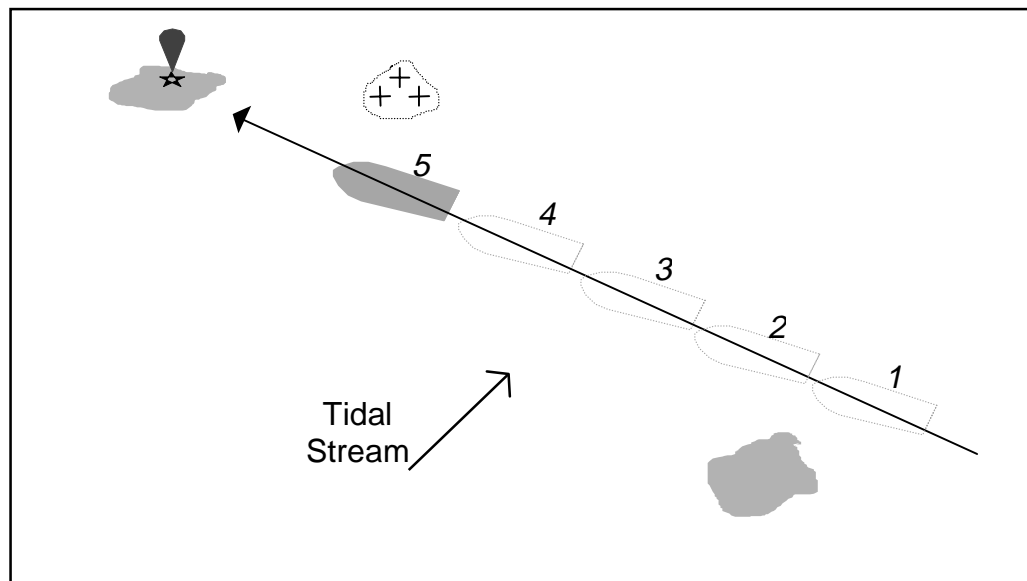

Figure 8.25 Maintaining the intended track using compass bearings